

Makita[®]

IPL.BE
GROUP



XGT

PROMOFOLDER
01/04/2025 - 30/09/2025

NIEUWIGHEDEN

| Artikel | Pagina |
|------------|--------|
| TW010GZ01 | 11 |
| DK0227G201 | 18 |
| TM001GZ02 | 23 |
| TM001GZ03 | 23 |
| HS013GZ | 25 |
| RP001GZ02 | 27 |
| BS001GZ | 28 |
| BO007CGZ | 29 |
| PP001GZK | 31 |
| DK0114G205 | 32 |
| DK0229G401 | 33 |
| DK0230G601 | 33 |
| DBN601ZJ | 55 |
| DBN610ZJ | 55 |
| DRT52Z | 62 |
| DTC301ZK | 72 |
| DTC302ZK | 72 |
| DHP492T1J | 76 |
| DLX2507T3J | 76 |
| DLX4183T3J | 76 |
| DLX7030T3J | 76 |
| CL004GZ | 97 |
| UB002GZ01 | 98 |
| PS001GZ | 106 |
| HR2670 | 108 |
| HR2670FTX2 | 108 |
| SKR001Z | 132 |
| DUV320Z | 137 |
| DUV320RT | 137 |
| UC029GZ | 147 |
| DUA200Z | 151 |

COMBOPACKS









| Artikel | Pagina |
|-------------------------|---------------|
| Combopacks XGT | 18, 24, 32-33 |
| Combopacks LXT | 75-77 |
| Combopacks CXT | 80 |
| Combopacks cleaning | 97 |
| Combopacks slijpers | 118 |
| Combopacks zaagmachines | 123 |
| Combopacks tuin | 160 |

PROMOTIES

| Artikel | Promotie | Pagina |
|------------|-------------------|--------|
| HP001GM201 | E-05337 + E-15154 | 8 |
| TW007GD201 | E-16586 | 10 |
| CE001GZ | E-12996 | 20 |
| LS002GZ01 | DEBWST06 | 26 |
| LS004GZ01 | DEBWST06 | 26 |
| LS003GZ01 | DEBWST06 | 26 |
| DK0124G201 | BL4025 | 32 |
| DK0125G301 | BL4040 | 32 |
| 191L77-9 | STUNTPRIJS | 35 |
| 1911V6-0 | STUNTPRIJS | 35 |
| DDF485RTJ | STUNTPRIJS | 47 |
| DDF484RTJ | STUNTPRIJS | 47 |
| DDF489RTJ | STUNTPRIJS | 47 |
| DHP484RTJ | STUNTPRIJS | 47 |
| DHP489RTJ | STUNTPRIJS | 47 |
| DHP486RT3J | STUNTPRIJS | 47 |
| DHR243RTJ | BL1850B | 48 |
| DTW700RTJ | E-06616 | 51 |
| DHS680RTJ | BL1850B | 58 |
| DGA506RTJ | BL1850B | 68 |
| DGA508RTJ | BL1850B | 68 |
| DTR180ZJ | 191A57-9 | 71 |

PROMOTIES

| | | |
|------------|------------------|-----|
| DLX2522TJ | E-16732 | 75 |
| DLX2507T3J | B-55697 | 76 |
| DGA506T1J | D-18770-10 | 77 |
| DGA508T1J | D-18770-10 | 77 |
| HR2670FTX2 | D-42444 | 108 |
| HR2631FT12 | D-42444 | 108 |
| HR2651TX12 | D-42444 | 108 |
| HR4013C | P-52445 | 109 |
| HR4511C | P-52445 | 109 |
| HR5212C | P-52445 | 109 |
| HM0871C | E-20236 | 110 |
| HM1812 | D-54972 | 111 |
| GA5092X01 | 195354-9 | 116 |
| GA5090X01 | 195354-9 | 116 |
| GA5091X01 | 195354-9 | 116 |
| GA5095X01 | 195354-9 | 116 |
| GA5094 | 195354-9 | 116 |
| GA5093X01 | 195354-9 | 116 |
| LS1019L | DEBWST06 | 125 |
| LS1219L | DEBWST06 | 125 |
| SKR200Z | P-81315 | 129 |
| SK105DZ | BL1021B + DC10SB | 130 |
| SK105GDZ | BL1021B + DC10SB | 130 |
| SK106GDZ | BL1021B + DC10SB | 130 |
| SK10GDZ | 197658-5 | 130 |
| SK20GDZ | 197658-5 | 130 |
| SK40GDZ | 197658-5 | 130 |
| SK209GDZ | 197658-5 | 130 |
| SK312GDZ | 197658-5 | 130 |
| SK700DZ | 197658-5 | 131 |
| SK700GDZ | 197658-5 | 131 |
| DLM480CT2 | STUNTPRIJS | 133 |
| UM600DSAEX | 831253-8 | 139 |
| DUM111SYX | 831253-8 | 139 |
| DUM604RFEX | 831253-8 | 139 |
| DCU180Z | 199099-8 | 159 |

| | | |
|---|-----------------------|-----|
|  | XGT - 40Vmax | 6 |
|  | LXT - 18 V / 2 x 18 V | 42 |
|  | CXT - 12Vmax | 80 |
|  | Outdoor | 86 |
|  | Cleaning | 96 |
|  | Elektrisch | 108 |
|  | Lasers | 129 |
|  | Tuin | 133 |



Makita Service

Makita staat bekend om zijn expertise, kwaliteit en service...

Maar wat maakt de service van Makita nu zo uniek? Wij vroegen het aan Yves (supervisor) en Johan (teamleader) van de technische dienst.

Help, mijn machine is stuk!

"Als er iets aan de hand is met je machine, kan je je toestel best binnenbrengen bij een erkende Makitadealer. Die kan je vinden via de dealerlocator op onze website. Sommige dealers zijn servicedealers en doen de reparaties zelf, de anderen sturen de toestellen op naar ons. Die toestellen komen dan binnen op de hersteldienst bij Makita Kortenbergh of Charleroi. Per jaar repareren wij zo'n 30.000 machines."

Hoelang duurt een reparatie?

"Wij streven naar een reparatie binnen de 24 tot 48 uur. We zijn sowieso al snel omdat de verzending van de dealer naar onze magazijnen vlotter verloopt dan wanneer de herstelling in het buitenland gebeurt. Wanneer een machine binnenkomt bekijken we het vrijwel meteen. Het Makitagereedschap is ook zo gemaakt dat het gemakkelijk te herstellen is. Alles is bijvoorbeeld met dezelfde schroeven vastgemaakt. Veel servicedealers zeggen dat ze het liefst aan een Makita sleutelen."

"Soms kan een herstelling langer duren dan verwacht omdat we een onderdeel moeten bijbestellen. Dat gebeurt niet zo heel vaak, aangezien wij 185.107 onderdelen in onze magazijnen hebben klaarliggen. Wij houden de stukken voor machines soms jaren bij, we hebben zelfs nog stukken uit 1980."

Hoe werkt de garantie bij Makita?

"Op gebied van garantie hebben particulieren twee jaar garantie en professionals één jaar, dat is wettelijk bepaald. Wanneer je het toestel registreert via MyMakita op onze website kan je wel tot drie jaar garantie krijgen, ongeacht of je een professional of een particulier bent."

Wat als het toestel niet (meer) onder garantie is?

"Je kan je toestel nog altijd laten maken. Vanaf de reparatie duurder is dan 45% van de nieuwprijs maken wij een bestek op. Dan geven wij dit door via de dealer."

"We krijgen wel vaker machines binnen die niet meer onder garantie zijn, zo deed ik overlaats nog een reparatie voor een klopper uit 1982. Sommige machines zijn zo oud dat er zelfs geen datum opstaat. Machines uit 2000 komen nog heel vaak binnen, wij stellen dan wel eerst een voorstel voor de klant op, zeker als de machine al meer dan 20 jaar oud is."

"Je kan trouwens ook het onderhoud van je machines laten doen bij Makita, dat kunnen klanten aanvragen bij hun dealer. Wanneer we het toestel bekijken en we vinden dat geen onderhoud nodig is, doen we dat ook niet."

20 MEDEWERKERS



OP DE TECHNISCHE DIENST



30.000+
herstellingen per jaar

185.107

onderdelen in de magazijnen



**Makita blijft de
Rolls Royce van
het elektrisch
gereedschap**

Wat maakt de service van Makita uniek?

Johan: "We werken heel snel door onze eigen herstellingsdiensten in België. Daardoor is die prijs-kwaliteit uitstekend, de klant betaalt niet veel voor goede herstellingen."

Yves: "Het is eigenlijk bijna ambachtelijk. We analyseren elk toestel grondig, herstellen wat kapot is en werken niet in modules. Tot het kleinste vijsje kan bij ons vervangen worden. Dat is duurzamer én goedkoper voor de klant."

"Bovendien zijn wij telefonisch bereikbaar. Klanten kunnen hun verhaal doen, zo weten wij ook beter hoe we het toestel moeten repareren. Op die manier kunnen wij klanten op de hoogte houden van hun herstelling en een bestek opmaken. Dan kan de klant zelf nog beslissen of die de herstelling wil laten uitvoeren voor de voorgestelde prijs of het wil omruilen voor een vergelijkbaar toestel met 10% korting. Ook de servicedealers kunnen ons altijd bereiken als er iets niet lukt met hun herstelling. Die servicedealers krijgen trouwens ook hun opleiding door ons, bij Makita. Op die manier geven we de beste ondersteuning aan dealers en eindklanten."

Yves: "Als je het mij vraagt, de service van Makita is formidabel en gebouwd op een team." Een team met veel ervaring. Alle knowhow zit dan ook onder één dak bij Makita: onze customer service en technische dienst kunnen met elkaar in gesprek gaan en dat is een meerwaarde. U weet waarover u praat. Wij ook.



GEKSTE MACHINE

Johan: "We kregen ongeveer een jaar geleden een tandvrij voor paarden binnen. Paarden hebben kiezen die blijven groeien en dan bijgevoerd moeten worden. Lang geleden verkochten we dit bij Makita en soms duikt er nog eens eentje op voor een reparatie."

TIPS

"Jouw machines graag zien en de handleiding lezen..."

MAKITA IN ÉÉN ZIN

"Makita blijft de Rolls Royce van het elektrisch gereedschap."

40V^{Li-ION} max

XGT

XGT-batterijen



Piekvermogen
0.9 kW



2.0 Ah BL4020



Piekvermogen
1.1 kW



2.5 Ah BL4025



Piekvermogen
1.5 kW



4.0 Ah BL4040

XGT is een nieuw platform met specifieke machines, accu's en laders. De combinatie van innovatief design en accu's met een hoog piekvermogen bieden een sterk alternatief voor de veeleisende industriële gebruikers.

Optimale stroomvoorziening en efficiënt oplaadsysteem

De XGT-gereedschappen en -batterijen zijn uitgerust met een ingebouwd programma voor digitale communicatie tussen de batterij en het gereedschap. Hierdoor kan de batterij niet alleen met het gereedschap communiceren, maar ook het gereedschap met de batterij. XGT staat voor innovatieve batterij- en motortechnologie die samenwerken voor optimale prestaties.

Gereedschap ◀▶ Batterij ◀▶ Lader
Digitale communicatie

Efficiënt oplaadsysteem

Automatisch systeem voor onderhoud met twee koelluchtventilatoren voor een snellere optimale lading.



40Vmax mechanisme video

Deze video is gemaakt in Japan, modellen en specificaties kunnen verschillen.



piekvermogen **2.1 kW**

piekvermogen **2.8 kW**

POWER

4.0 Ah BL4040F | **5.0 Ah** BL4050F

8.0 Ah BL4080F

Robuust design

Hoge duurzaamheid, speciaal ontworpen voor 40Vmax Li-Ion batterijen

4 laadindicatie LED-lampjes

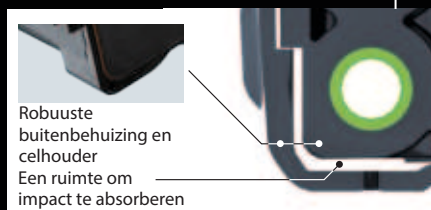

schokbestendig ontwerp

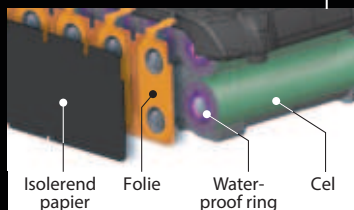

Waterdichte drievoudige laagstructuur voorkomt celuitval door water en stof.

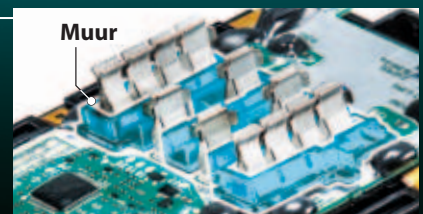

Kortsluitingsbeveiliging van de aansluitpunten: de beschermmuur is geplaatst tussen de aansluitpunten ter bescherming tegen water en stof.

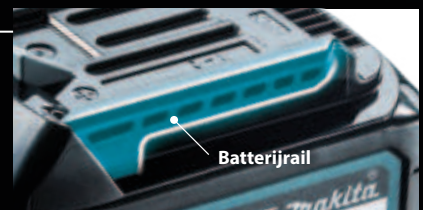

Sterke batterijrails
Duurzame schuifrails die de batterij en het gereedschap stevig en veilig vasthouden, zodat deze de kracht van machines met hoog vermogen kunnen ondersteunen.



DF002GD201

HP001GM201

HP001G / DF001G

- Maximaal koppel tot 140 Nm
- Tot 35 % hogere snelheid
- Bestand tegen continu werken onder hoge belasting



Active Feedback sensing Technology
Schakelt de machine uit bij een plotse zwenkbeweging.



41 elektronische koppelinstellingen
Voor een groter instelbereik en grotere nauwkeurigheid.



HP001GM201:
gratis gereedschapsriem
E-05337 +
holster
E-15154

| | DF001GZ01 | DF002GZ01 | DF002GD201 | HP001GZ01 | HP001GM201 | HP002GZ01 | HP002GD201 |
|--------------------------|---------------|---------------|---------------|---------------|---------------|---------------|---------------|
| Spanning | 36 V (40Vmax) | 36 V (40Vmax) | 36 V (40Vmax) | 36 V (40Vmax) | 36 V (40Vmax) | 36 V (40Vmax) | 36 V (40Vmax) |
| Bijgeleverde accu's | 0 | 0 | 2 x BL4025 | 0 | 2 x BL4040 | 0 | 2 x BL4025 |
| Lader | - | - | DC40RA | - | DC40RA | - | DC40RA |
| Max. koppel zacht / hard | 68 / 140 Nm | 30 / 64 Nm | 30 / 64 Nm | 68 / 140 Nm | 68 / 140 Nm | 30 / 64 Nm | 30 / 64 Nm |
| Boorkop | 1,5 - 13 mm | 1,5 - 13 mm | 1,5 - 13 mm | 1,5 - 13 mm | 1,5 - 13 mm | 1,5 - 13 mm | 1,5 - 13 mm |
| Klopboorfunctie | - | - | - | ✓ | ✓ | ✓ | ✓ |
| Gewicht | 2,7 kg | 2,5 kg | 2,5 kg | 2,7 kg | 2,7 kg | 2,6 kg | 2,6 kg |
| Prijs in € | excl. btw | | | | | | |
| | incl. btw | | | | | | |

MULTIMATERIAALBOREN



E-14255

5-delige boorset, cilindrisch
bevat diameters 4, 5, 6, 8 en 10 mm

excl. btw incl. btw



Multimateriaal-boorset, geschikt voor:
- Baksteen
- Hout
- Tegels
- PVC
- Aluminium
- Metaal



E-16732

5-delige boorset, hexagonaal
bevat diameters 4, 5, 6, 8 en 10 mm





excl. btw incl. btw



Multimateriaal-boorset, geschikt voor:
- Baksteen
- Hout
- Tegels
- PVC
- Aluminium
- Metaal

NEXT GENERATION TECHNOLOGY

31-DELIGE SCHROEFBITSET IMPACT BLACK (E-22850)

- Bevat:**
-  25 mm bits: PH1 (1st), PH2 (3st), PH3 (1st), PZ1 (1st), PZ2 (3st), PZ3 (1st), T15 (1st), T20(2st), T25 (1st), T30 (1st)
 -  50mm bits: PH2 (1st), PZ2 (1st), T15 (1st), T20 (1st), T25 (1st), T30 (1st)
 -  HSS-boren: diameter 2,5, 3,0, 3,5, 4,0, 4,5, 5,0
 -  Magnetische bithouder: 60 mm
 -  Magnetische krachtdop: 6 mm, 8 mm, 10 mm



**Schroefbitset
E-22850**
31 stuks Impact Black

ACCU SLAGSCHROEVENDRAAIERS



**TD002:
verlichting
met 4 led's**



TD002GZ04



TD003GZ01



TD001GZ02

| | TD003GZ01 | TD001GZ02 | TD002GZ04 |
|---------------------|---------------|---------------|---------------|
| Spanning | 36 V (40Vmax) | 36 V (40Vmax) | 36 V (40Vmax) |
| Bijgeleverde accu's | - | - | - |
| Lader | - | - | - |
| Bitopname | 1/4 " hex | 1/4 " hex | 1/4 " hex |
| Max. koppel | 210 Nm | 220 Nm | 220 Nm |
| Slagkrachtniveaus | 4 | 4 | 4 |
| Hulpfuncties | 1 | 6 | 6 |
| Gewicht | 1,7-2,9 kg | 1,7-2,9 kg | 1,7-2,9 kg |
| Prijs in € | excl. btw | | |
| | incl. btw | | |



"Dual spring technology" (TD002G):
Het slagmechanisme wordt aangedreven door één veer bij licht gebruik en twee veren in zwaar gebruik. Daardoor wordt het slagvermogen beter aangepast aan de belasting. De machine produceert minder trillingen en lawaai bij licht werk en anderzijds is bij het maximum vermogen de slagkracht hoger.

ACCU SLAGMOERSLEUTELS



TW004GD201



TW007GD201



TW002GZ



Robuust slag-mechanisme

Promo:
gratis 14-delige
doppenset
IMPACT BLACK
E-16586
bij TW007GD201

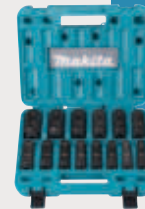

TW001G

| | TW004GZ01 | TW004GD201 | TW007GZ01 | TW007GD201 | TW002GZ | TW001GZ01 |
|---------------------|----------------|----------------|-----------------|-----------------|----------------|----------------|
| Spanning | 36 V (40Vmax) | 36 V (40Vmax) | 36 V (40Vmax) | 36 V (40Vmax) | 36 V (40Vmax) | 36 V (40Vmax) |
| Bijgeleverde accu's | 0 | 2 x BL4025 | 0 | 2x BL4025 | 0 | 0 |
| Bijgeleverde lader | - | DC40RA | - | DC40RA | - | - |
| Toerental | 0 - 3200 t.p.m | 0 - 3200 t.p.m | 600 -2300 t.p.m | 600 -2300 t.p.m | 0 - 1800 t.p.m | 0 - 1800 t.p.m |
| Max. koppel | 350 Nm | 350 Nm | 760 Nm | 760 Nm | 1700 Nm | 1800 Nm |
| Dopaansluiting | 1/2" | 1/2" | 1/2" | 1/2" | 1/2" | 3/4" |
| Verpakking | Makpac | Makpac | Makpac | Makpac | Makpac | Makpac |
| Gewicht | 1,9 - 2,2 kg | 1,9 - 2,2 kg | 2,7 - 3,3 kg | 2,7 - 3,3 kg | 3,9 - 5,1 kg | 3,9 - 4,2 kg |
| Prijs in € | excl. btw | | | | | |
| | incl. btw | | | | | |



ACCU BREEKMOERSLEUTEL



- Voor het vastzetten van breekbouten (type HTB en SHTB)
- Compatibel met boutmaten M16 – M20 – M22
- Accessoires voor M20 en M22 bijgeleverd
- Breekbouten worden vooral gebruikt bij industriële staalconstructies.

| | | WT001GZ |
|----------------------|-----------|----------------------|
| Spanning | | 36 V (40Vmax) |
| Accu's/lader | | - |
| Toerental onbelast | | 17 min ⁻¹ |
| Max. koppel | | 804 Nm |
| Compatibiliteit HTB | | M16, M20, M22 |
| Compatibiliteit SHTB | | M16, M20 |
| Gewicht | | 5,2 - 5,9 kg |
| Prijs in € | excl. btw | |
| | incl. btw | |

ACCU SLAGMOERSLEUTELS



TW010GZ01

TW010GZ01

- Zeer hoog koppel en uitstekende wendbaarheid
- Met verlengde aansluiting om ook verzonken bouten te kunnen bereiken
- Elektronische 4-traps selectie van de slagkracht
- Autostopsysteem met verschillende reactietijden bij vast- en losdraaien
- Triggerschakelaar met selecteerbare variabele snelheid of mode snelle acceleratie
- De handgreep is zonder gereedschap in verschillende posities verstelbaar
- De speciale ophanging van de accu beschermt deze tegen schokken en trillingen



De TW010G heeft een **verlengd aambeeld** om ook verzonken bouten te kunnen bereiken.

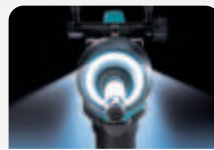

Gelijkmatige verlichting zonder schaduwen dankzij LED lichtring.



Elektronische 4-traps selectie van de slagkracht, autostopsysteem en mode voor snelle acceleratie.



NIEUW

TW010GZ01

| | |
|-----------------------------|-------------------------|
| Spanning | 36V (40Vmax) |
| Bijgeleverde accu's | - |
| Bijgeleverde lader | - |
| Toerental | 0-1200min ⁻¹ |
| Koppel (Max/Hard/Med./Soft) | 3150/1600/1000/600 Nm |
| Losdraaikoppel | 4000 Nm |
| Dopaansluiting | 1" |
| Verpakking | Koffer |
| Gewicht | 11,0 - 11,9 kg |
| Prijs in € | excl. btw |
| | incl. btw |

KRACHTDOPPEN 1"

| | Artikel | Omschrijving | Dopmaat (mm) | Lengte (mm) | Verpakkings-eenheid | Prijs excl. btw | Prijs incl. btw |
|--|---------|--------------|--------------|-------------|---------------------|-----------------|-----------------|
| | E-24561 | normaal | 36 | 66 | 1 | | |
| | E-24599 | normaal | 41 | 68 | 1 | | |
| | E-24620 | normaal | 46 | 72 | 1 | | |
| | E-24636 | normaal | 50 | 76 | 1 | | |
| | E-24642 | normaal | 55 | 84 | 1 | | |
| | E-24658 | normaal | 60 | 88 | 1 | | |
| | E-24664 | normaal | 65 | 92 | 1 | | |
| | E-24670 | normaal | 70 | 96 | 1 | | |
| | E-24739 | diep | 36 | 90 | 1 | | |
| | E-22420 | diep | 41 | 90 | 1 | | |
| | E-24773 | diep | 46 | 90 | 1 | | |
| | E-24795 | diep | 55 | 108 | 1 | | |
| | E-24804 | diep | 60 | 108 | 1 | | |
| | E-24810 | diep | 65 | 120 | 1 | | |

| | Artikel | Omschrijving | Diameter (mm) | Verpakkingseenheid | Prijs excl. btw | Prijs incl. btw |
|--|---------|--------------|---------------|--------------------|-----------------|-----------------|
| | E-22436 | O-ring | 41 | 1 | | |
| | E-22442 | Pin | 41 | 1 | | |

4-snijder hamerboren met lasergelaste hardmetalen boorpunt

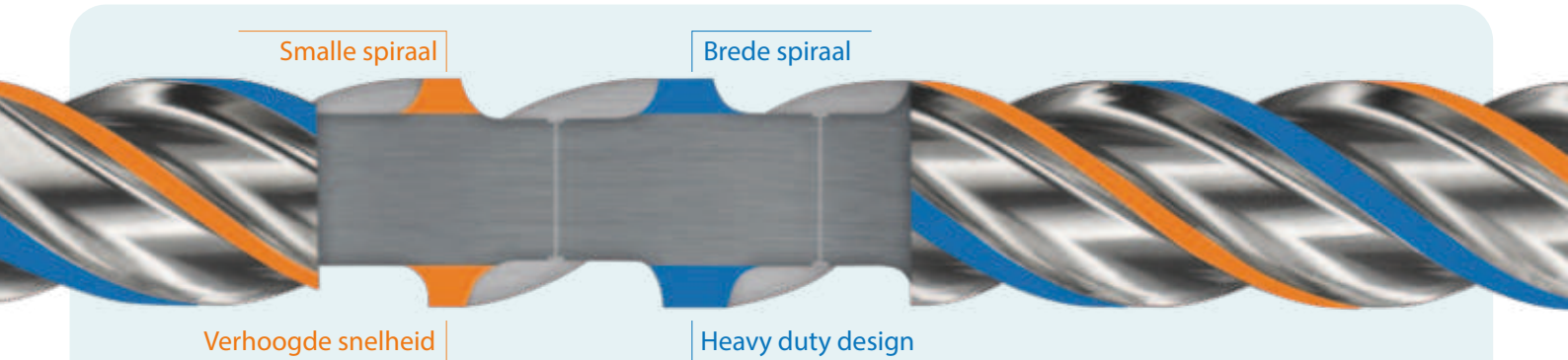

Smalle spiraal

Brede spiraal

Verhoogde snelheid

Heavy duty design

Hogere Snelheid

- > De smalle spiraal zorgt voor minder wrijving en snellere boorprestaties!
- > Vlottere afvoer van het boorgruis dankzij het lasergelaste boorpunt en de dubbele spiraal.
- > Lasergelaste carbide boorpunten t.e.m. Ø 20 mm.

Zware klus

- > De brede spiraal zorgt voor een structurele versterking van de kern en minder last van slijtage.
- > Dankzij het robuust ontwerp is de Nemesis II-boor veilig, geschikt voor de zwaarste klus en loopt ze niet vast op betonstaal.

Langere levensduur

- > Verhoogde weerstand tegen oververhitting dankzij het lasergelaste boorpunt.
- > Het solide uit 1 stuk vervaardigd hardmetalen boorpunt zorgt voor lage vibraties en optimale boorprestaties.

Ø 5 – 10 mm

4-snijder: Solide hardmetalen boorpunt



Ø 11 – 16 mm

4-snijder: Solide uit één stuk vervaardigd hardmetalen boorpunt



SCAN HIER



Voor volledige assortiment

Ø 18 – 32 mm

4-snijder: Solide driedelig hardmetalen boorpunt



ACCU HAAKSE BOORMACHINE



DA001GM101

- Zeer hoog koppel (136 Nm)
- Twee mechanische snelheden
- Ingebouwde mechanische slipkoppeling

| | DA001GZ01 | DA001GM101 |
|---------------------|-----------------------------------|-----------------------------------|
| Spanning | 36 V (40Vmax) | 36 V (40Vmax) |
| Bijgeleverde accu's | - | 1 x BL4040 |
| Bijgeleverde lader | - | DC40RA |
| Toerental | 0 - 400 t.p.m. 0 - 1500 t.p.m. | 0 - 400 t.p.m. 0 - 1500 t.p.m. |
| Hard koppel | 70/136 Nm | 70/136 Nm |
| Boorkop | 13 mm | 13 mm |
| Gewicht | 5,3 - 6,2 kg | 5,3 - 6,2 kg |
| Prijs in € | excl. btw | |
| | incl. btw | |

ACCU COMBIHAMERS SDS-PLUS



HR10GZ01



HR007GM201

HR10G

- Licht, compact en toch krachtig
- Speciale behuizing en handgreep reduceren de trillingen
- Optioneel verkrijgbaar: DX16 stofafzuigingsunit
- De perfecte oplossing voor het boren van kleinere diameters!



HR002GM204



HR009GZ02

| | HR10GZ01 | HR007GZ01 | HR007GM201 | HR002GZ02 | HR002GM204 | HR009GZ02 | HR009GM202 |
|----------------------|-------------------------|-------------------------|-------------------------|----------------------|----------------------|-------------------------|-------------------------|
| Spanning | 36 V (40Vmax) | 36 V (40Vmax) | 36 V (40Vmax) | 36 V (40Vmax) | 36 V (40Vmax) | 36 V (40Vmax) | 36 V (40Vmax) |
| Bijgeleverde accu's | - | - | 2 x BL4040 | - | 2 x BL4040 | - | 2 x BL4040 |
| Lader | - | - | DC40RA | - | DC40RA | - | DC40RA |
| Slagenergie | 2,0 J | 3,0 J | 3,0 J | 2,9 J | 2,9 J | 3,9 J | 3,9 J |
| Max. Ø beton | 20 mm | 28 mm | 28 mm | 28 mm | 28 mm | 30 mm | 30 mm |
| AFT | - | ✓ | ✓ | ✓ | ✓ | ✓ | ✓ |
| Trillingsniveau (ah) | 10,0 m/s ² | 7,5 m/s ² | 7,5 m/s ² | 6,0 m/s ² | 6,0 m/s ² | 9,1 m/s ² | 9,1 m/s ² |
| Stofafzuigingsunit | DX16: optioneel | DX15: optioneel | DX15: optioneel | DX14: optioneel | DX14: inbegrepen | DX11: inbegrepen | DX11: inbegrepen |
| AWS | ✓(excl. Bluetooth unit) | ✓(excl. Bluetooth unit) | ✓(excl. Bluetooth unit) | ✓ | ✓ | ✓(excl. Bluetooth unit) | ✓(excl. Bluetooth unit) |
| Gewicht | 2,9 - 4,5 kg | 3,8 - 4,8 kg | 3,8 - 4,8 kg | 4,1 - 4,6 kg | 4,1 - 4,6 kg | 5,3 - 6,7 kg | 5,3 - 6,7 kg |
| Prijs in € | excl. btw | | | | | | |
| | incl. btw | | | | | | |

AFT Active feedback sensing technology

Deze technologie schakelt de motor onmiddellijk uit bij het plots blokkeren van de machine. Sommige machines maken daarbij gebruik van een accelerometer die de zwenkbeweging van de machine detecteert. De AFT-technologie verhoogt de veiligheid enorm.



Slagenergie
8,0 J



HR005GM202



HR006GZ

Slagenergie
20,0 J

HR005G

- Uitstekende vermogen/gewichtsverhouding
- Beveiliging tegen terugslag (AFT met accelerometer)
- Actieve trillingsdemping (AVT)

HR006G

- 2 x 40Vmax accu's in serie zorgen voor extreme kracht
- Beveiliging tegen terugslag (AFT met accelerometer)
- Actieve trillingsdemping (AVT)

| | HR005GZ01 | HR005GM202 | HR006GZ |
|----------------------|-------------------------------|-------------------------------|-------------------------------|
| Spanning | 36 V (40 Vmax) | 36 V (40 Vmax) | 2 x 36 V (40 Vmax) |
| Bijgeleverde Accu's | - | 2 x BL4040 | - |
| Slagenergie | 8,0 J | 8,0 J | 20,0 J |
| Slagfrequentie | 1450 - 2900 min ⁻¹ | 1450 - 2900 min ⁻¹ | 1100 - 2250 min ⁻¹ |
| Trillingsniveau (ah) | 5 m/s ² | 5 m/s ² | 8,5 m/s ² |
| Capaciteit beton | 40 mm | 40 mm | 52 mm |
| Toerental onbelast | 250 - 500 min ⁻¹ | 250 - 500 min ⁻¹ | 250 - 310 min ⁻¹ |
| AFT | ✓ | ✓ | ✓ |
| AWS | ✓ | ✓ | ✓ (excl. Bluetooth unit) |
| Gewicht | 7,4 kg - 8,2 kg | 7,4 kg - 8,2 kg | 12,9 - 14,3 kg |
| Prijs in € | excl. btw | | |
| | incl. btw | | |

PREMIUM BEITELSET SDS-PLUS EN SDS-MAX

- ✓ 2 keer langere levensduur dan de standaard beitels!
- ✓ Zeer efficiënt: vormvast. Het afbraakwerk is veel productiever!

3-DELIGE PREMIUM BEITELSET SDS-PLUS

5-DELIGE PREMIUM BEITELSET SDS-MAX

SDS-PLUS

E-20220

excl. btw

incl. btw



1 puntbeitel 250 mm
1 koudbeitel 20 x 250 mm
1 platte beitel 40 x 250 mm



AntiJam™ ontwerp

Verhoogt de productiviteit
Vermindert de wrijving en de kans op blokkeren
Speciaal ontworpen voor SDS-PLUS machines

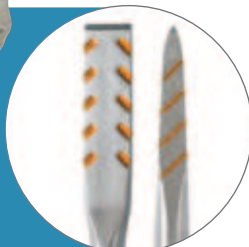

SDS-MAX

E-20236

excl. btw

incl. btw



2 puntbeitels 400 mm
2 koudbeitels 25 x 400 mm
1 platte beitel 50 x 380 mm



BreakPower™ ontwerp

Verhoogt de productiviteit
Vermindert de wrijving en de kans op blokkeren
Speciaal ontworpen voor SDS-MAX machines

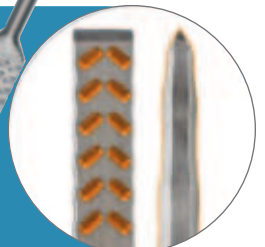

ACCU BREEKHAMERS SDS-MAX

BL
MOTOR

XGT
40V Li-ion
max

XGT X2
80V max

HM001G



- Evenaart de kracht van modellen op netstroom
- Hoge slagenergie (9,4 J)
- Uitzonderlijk laag trillingsniveau dankzij actieve trillingsdemping (AVT) en een anti-vibratie behuizing



HM001GM205

Slagenergie
9,4 J



HM002GZ03

Slagenergie
20,0 J

HM002G



- Extreem krachtig dankzij twee 40Vmax accu's in serie
- Zeer hoge slagenergie (20 J)
- Uitzonderlijk laag trillingsniveau dankzij actieve trillingsdemping (AVT) en een anti-vibratie behuizing

| | HM001GZ04 | HM001GM205 | HM002GZ03 |
|--------------------------------|----------------------------|----------------------------|------------------------------|
| Spanning | 36 V (40Vmax) | 36 V (40Vmax) | 2 x 36 V (40Vmax) |
| Bijgeleverde accu's | - | 2 x BL4040 | - |
| Bijgeleverde lader | - | DC40RA | - |
| Slagenergie | 9,4 J | 9,4 J | 20 J |
| Slagfrequentie | 0 - 2650 min ⁻¹ | 0 - 2650 min ⁻¹ | 950 - 1900 min ⁻¹ |
| Triax. vibratie beitelten (ah) | 6,0 m/s ² | 6,0 m/s ² | 8,0 m/s ² |
| AWS | ✓ | ✓ | ✓ excl. Bluetooth unit |
| Gewicht | 6,3 - 7,1 kg | 6,3 - 7,1 kg | 12,0 - 13,3 kg |
| Prijs in € | excl. btw | | |
| | incl. btw | | |



ACCU BREEKHAMER SDS-MAX

BL
MOTOR

XGT
40V Li-ION
max

HM004G

- Zeer krachtige accubreekhamer met impactenergie van 72,8 J, vergelijkbaar met modellen op netstroom
- Grote energiecapaciteit (autonomie) bij gebruik van twee 8,0 Ah 40Vmax accu's
- Uitstekende trillingsdemping (AVT)
- Uitstekend zicht op de beitel

Actieve trillingsdemping met bewegend tegengewicht (AVT)

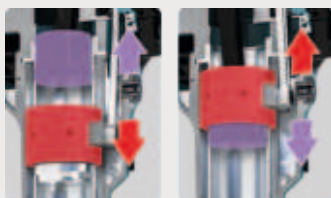

Tegengewicht

Piston



HM004GZ01



Optioneel accessoire:
trolley (JM00000674)

HM004GZ01

| | |
|---------------------|-----------------------|
| Spanning | 72 V (80Vmax) |
| Bijgeleverde accu's | - |
| Opname | 28,6 mm |
| Slagenergie | 72,8 J |
| Slagfrequentie | 870 min ⁻¹ |
| Trillingsniveau | 6,5 m/s ² |
| AWS | ✓ |
| Gewicht | 29,7 - 32,1 kg |
| Prijs in € | excl. btw |
| | incl. btw |

Om de dikte van de machine te beperken zijn de accu's zijdelings geplaatst. Daardoor is de werkhouding comfortabel en het zicht op de beitel uitstekend.



De behuizing is via trillingsdempende veren met het binnenste deel verbonden om nog minder trillingen op de armen door te geven



NEXT GENERATION TECHNOLOGY

ACCU METAALCIRKELZAAG 185 MM



CS002GZ

- Grote snijcapaciteit dankzij de compacte tandwieloverbrenging
- Compartiment in aluminium voor het opvangen van metaalsnippers
- De AFT functie schakelt de motor onmiddellijk uit wanneer het zaagblad blokkeert

| | | CS002GZ |
|---------------------------|-----------|------------------------|
| Spanning | | 36 V (40Vmax) |
| Bijgeleverde accu's/lader | | - |
| Ø zaagblad | | 185 mm |
| Toerental onbelast | | 3500 min ⁻¹ |
| Max. zaagdiepte | | 67 mm |
| Trillingsniveau (ah) | | 2,5 m/s ² |
| Gewicht | | 4,2 - 5,4 kg |
| Prijs in € | excl. btw | |
| | incl. btw | |

ACCU MENGERS



- Zeer krachtig, ook geschikt voor het mengen van zwaardere materialen
- Mechanische overbrenging met 2 snelheden
- Duimwiel voor het instellen van het maximaal toerental, variabel toerental regeling, aan-vergrendelknop en uit-vergrendelknop, softstart
- Inschroefbare ashouder met adapter M12 + M14 binnendraad
- Uitstekende bescherming van schakelaar en accu

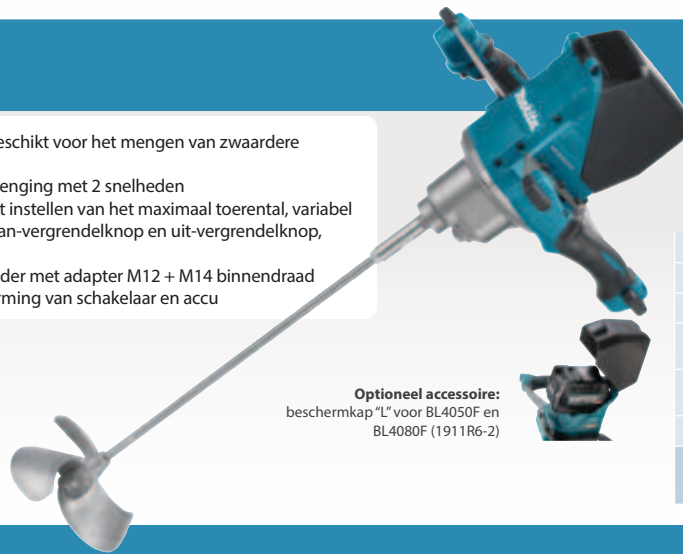

Optioneel accessoire:
beschermkap "L" voor BL4050F en BL4080F (1911R6-2)

| | | UT001GZ02 |
|---------------------|-----------|--|
| Spanning | | 36V (40Vmax) |
| Bijgeleverde accu's | | - |
| Bijgeleverde lader | | - |
| Toerental onbelast | | 0- 500min ⁻¹ 0- 920min ⁻¹ |
| Aansluiting | | 1/2" - 20 UNF Male Adapter M12 & M14 |
| Gewicht | | 5,7-7,0 kg |
| Prijs in € | excl. btw | |
| | incl. btw | |

ACCU BETONTRILNAALDEN



VR001GZ



VR004GM101



ACCESSOIRES

| Artikel | Diameter | Lengte | Prijs excl. btw | Prijs incl. btw |
|----------|----------|--------|-----------------|-----------------|
| 1910E1-5 | 32 mm | 1,2 m | | |
| 1910E2-3 | 32 mm | 1,7 m | | |
| 1910C2-9 | 32 mm | 2,4 m | | |
| 1910E3-1 | 38 mm | 1,2 m | | |
| 1910C4-5 | 38 mm | 2,4 m | | |



| | VR001GZ | VR003GZ | VR004GZ | VR004GM101 |
|---------------------|-------------------------------|-------------------------------|-------------------------------|-------------------------------|
| Spanning | 36 v (40Vmax) | 36 v (40Vmax) | 36 v (40Vmax) | 36 v (40Vmax) |
| Bijgeleverde accu's | - | - | - | 1x BL4040 |
| Bijgeleverde lader | - | - | - | DC40RA |
| Ø triffles | -(enkel motor) | 32 mm | 38 mm | 38 mm |
| Lengte naald | -(enkel motor) | 1,2 m | 1,2 m | 1,2 m |
| Trillingsfrequentie | 12000-15000 min ⁻¹ | 12000-15000 min ⁻¹ | 12000-15000 min ⁻¹ | 12000-15000 min ⁻¹ |
| Gewicht | 4,8 - 7,8 kg | 4,8 - 7,8 kg | 4,8 - 7,8 kg | 4,8 - 7,8 kg |
| Prijs in € | excl. btw | | | |
| | incl. btw | | | |

ACCU HAAKSE SLIJERS 125 MM X-LOCK



191G05-4
STOFAFZUIGKAP X-LOCK

X-LOCK

Snel en veilig schijven bevestigen via een kliksysteem.



GA044GM201

| | GA041GZ | GA041GM201 | GA044GZ | GA044GM201 | GA047GZ | GA047GM201 |
|---------------------|---------------------------------|---------------------------------|---------------------------------|---------------------------------|-------------------------|-------------------------|
| Spanning | 36 V (40Vmax) | 36 V (40Vmax) | 36 V (40Vmax) | 36 V (40Vmax) | 36 V (40Vmax) | 36 V (40Vmax) |
| Bijgeleverde accu's | - | 2x BL4040 | - | 2x BL4040 | - | 2x BL4040 |
| Bijgeleverde lader | - | DC40RA | - | DC40RA | - | DC40RA |
| Schijfdiameter | 125 mm | 125 mm | 125 mm | 125 mm | 125 mm | 125 mm |
| Toerental onbelast | 3,000 - 8,500 min ⁻¹ | 3,000 - 8,500 min ⁻¹ | 3,000 - 8,500 min ⁻¹ | 3,000 - 8,500 min ⁻¹ | 8,500 min ⁻¹ | 8,500 min ⁻¹ |
| Slijpdiepte | 31 mm | 31 mm | 31 mm | 31 mm | 31 mm | 31 mm |
| Type schakelaar | Schuifschakelaar | Schuifschakelaar | Lepelschakelaar | Lepelschakelaar | Lepelschakelaar | Lepelschakelaar |
| Dodemansschakelaar | - | - | ✓ | ✓ | ✓ | ✓ |
| AWS | ✓ | ✓ | ✓ | ✓ | - | - |
| | excl. Bluetooth unit | excl. Bluetooth unit | excl. Bluetooth unit | excl. Bluetooth unit | - | - |
| Verpakking | - | Makpac | - | Makpac | - | Makpac |
| Gewicht | 3.0 - 5.3 kg | 3.0 - 5.3 kg | 3.0 - 5.3 kg | 3.0 - 5.3 kg | 3.0 - 5.3 kg | 3.0 - 5.3 kg |
| Prijs in € | excl. btw | | | | | |
| | incl. btw | | | | | |

XGT COMBOKIT



GA038

GA023

BL4040F

DC40RA

D-61145

D-61139

832367-6

DK0227G201

| | |
|-----------------------|-----------------|
| Spanning | 36 V (40Vmax) |
| Bijgeleverde accu's | 2x BL4040F |
| Bijgeleverde lader | DC40RA |
| Opname slijpers | M14 |
| Haakse slijper 125mm | GA023G |
| Haakse slijper 230 mm | GA038G |
| Verpakking | Gereedschapstas |
| Prijs in € | excl. btw |
| | incl. btw |

ACCESSOIRES X-LOCK

| Referentie | Type | Prijs excl. btw | Prijs incl. btw |
|------------|---|-----------------|-----------------|
| E-00393 | Afbraamschijf voor metaal 125 mm x 6 x 22,23 | | |
| E-00402 | Afbraamschijf voor inox 125 mm x 6 x 22,23 | | |
| E-00418 | Doorslijpschijf voor inox 125 mm x 1,2 x 22,23 | | |
| E-02076 | Diamantdoorslijpschijf 125 mm | | |
| D-73396 | Komborstel voor metaal, gegolfde draad 75 mm x 0,3 | | |
| D-73433 | Komborstel voor metaal, gegolfde draad, vermessingd 75 mm x 0,3 | | |
| D-73346 | Komborstel voor inox, gegolfde draad 75 mm x 0,3 | | |

| Referentie | Type | Prijs excl. btw | Prijs incl. btw |
|------------|---|-----------------|-----------------|
| D-73374 | Komborstel voor metaal, getordeerde draad 80 mm x 0,35 | | |
| D-73380 | Komborstel voor metaal, getordeerde draad 80 mm x 0,5 | | |
| D-73330 | Komborstel voor inox, getordeerde draad 80 mm x 0,5 | | |
| D-73449 | Kegelborstel voor metaal, gegolfde draad 100 mm x 0,3 | | |
| D-73411 | Schijfborstel voor metaal, getordeerde draad 115 mm x 0,5 | | |
| D-73427 | Schijfborstel voor metaal, gegolfde draad 115 mm x 0,3 | | |
| E-11776 | Doorslijpschijf TCG 125 mm x 2 x 22,23 X-Lock | | |
| E-19738 | Vacuüm gesoldeerde diamantschijf 125 mm | | |

NEXT GENERATION TECHNOLOGY

ACCU HAAKSE SLIJPERS 125 MM



GA050G

- Compact, zeer hoog vermogen en hoog toerental
- Speciale motorbehuizing in één stuk en trillings-absorberende rubbers tussen de binnen- en buitenkant
- Vernieuwd ontwerp met kleine greepomtrek



GA023GM201



GA050GZ

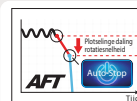

Active Feedback sensing Technology
Schakelt de motor uit bij het plots blokkeren van de schijf

STOFAFZUIGING VOOR SLIJPERS



191F81-2



191G06-2

Gereedschapsloze beschermkap

- Er is geen gereedschap nodig om de kap te monteren of te verwijderen.
- De beschermkap kan via een kliksysteem in de gewenste stand geplaatst worden.

| | GA005GZ01 | GA005GM201 | GA013GZ01 | GA013GM201 | GA050GZ | GA023GZ | GA023GM201 | GA029GZ | GA029GM201 |
|---------------------|------------------------------------|------------------------------------|--------------------------------------|--------------------------------------|--------------------------------------|------------------------------------|------------------------------------|--------------------------------------|--------------------------------------|
| Spanning | 36 V (40Vmax) | 36 V (40Vmax) | 36 V (40Vmax) | 36 V (40Vmax) | 36 V (40Vmax) | 36 V (40Vmax) | 36 V (40Vmax) | 36 V (40Vmax) | 36 V (40Vmax) |
| Bijgeleverde accu's | 0 | 2 x BL4040 | 0 | 2 x BL4040 | - | 0 | 2 x BL4040 | 0 | 2 x BL4040 |
| Bijgeleverde lader | - | DC40RA | - | DC40RA | - | - | DC40RA | - | DC40RA |
| Toerental onbelast | 8500 t.p.m. | 8500 t.p.m. | 8500 t.p.m. | 8500 t.p.m. | 11000 t.p.m. | 3000 - 8500 t.p.m. | 3000 - 8500 t.p.m. | 3000 - 8500 t.p.m. | 3000 - 8500 t.p.m. |
| Regelbaar toerental | - | - | - | - | - | ✓ | ✓ | ✓ | ✓ |
| Type schakelaar | Schuifschakelaar met vergrendeling | Schuifschakelaar met vergrendeling | Lepelschakelaar zonder vergrendeling | Lepelschakelaar zonder vergrendeling | Lepelschakelaar zonder vergrendeling | Schuifschakelaar met vergrendeling | Schuifschakelaar met vergrendeling | Lepelschakelaar zonder vergrendeling | Lepelschakelaar zonder vergrendeling |
| AWS | - | - | - | - | - | ✓ excl. Bluetooth unit | ✓ excl. Bluetooth unit | ✓ excl. Bluetooth unit | ✓ excl. Bluetooth unit |
| Verpakking | Makpac | Makpac | Makpac | Makpac | - | - | Makpac | - | Makpac |
| Gewicht | 3,0 kg | 3,0 kg | 3,0 kg | 3,0 kg | 3,0 kg | 3,0 kg | 3,0 kg | 3,0 kg | 3,0 kg |
| Prijs in € | excl. btw | | | | | | | | |
| | incl. btw | | | | | | | | |

ACCU HAAKSE SLIJPERS 150 MM / 180 MM / 230 MM



Compacte afmetingen en kleine omtrek van de handgreep



GA038GM201



| | GA035GZ | GA036GZ | GA037GZ01 | GA037GM201 | GA037GT201 | GA038GZ01 | GA038GM201 | GA038GT201 |
|---------------------|------------------------------------|--------------------------------------|--------------------------------------|--------------------------------------|--------------------------------------|--------------------------------------|--------------------------------------|--------------------------------------|
| Spanning | 36 V (40Vmax) | 36 V (40Vmax) | 36 V (40Vmax) | 36 V (40Vmax) | 36 V (40Vmax) | 36 V (40Vmax) | 36 V (40Vmax) | 36 V (40Vmax) |
| Bijgeleverde accu's | - | - | - | 2 x BL4040 | 2 x BL4050F | - | 2 x BL4040 | 2 x BL4050F |
| Bijgeleverde lader | - | - | - | DC40RA | DC40RA | - | DC40RA | DC40RA |
| Schijfdiameter | 150 mm | 150 mm | 180 mm | 180 mm | 180 mm | 230 mm | 230 mm | 230 mm |
| Toerental onbelast | 8500 min ⁻¹ | 8500 min ⁻¹ | 7800 min ⁻¹ | 7800 min ⁻¹ | 7800 min ⁻¹ | 6600 min ⁻¹ | 6600 min ⁻¹ | 6600 min ⁻¹ |
| Slijpdiepte | 46 mm | 46 mm | 68 mm | 68 mm | 68 mm | 73 mm | 73 mm | 73 mm |
| Type schakelaar | Schuifschakelaar met vergrendeling | Lepelschakelaar zonder vergrendeling | Lepelschakelaar zonder vergrendeling | Lepelschakelaar zonder vergrendeling | Lepelschakelaar zonder vergrendeling | Lepelschakelaar zonder vergrendeling | Lepelschakelaar zonder vergrendeling | Lepelschakelaar zonder vergrendeling |
| AWS | - | - | ✓ excl. Bluetooth unit | ✓ excl. Bluetooth unit | ✓ excl. Bluetooth unit | ✓ excl. Bluetooth unit | ✓ excl. Bluetooth unit | ✓ excl. Bluetooth unit |
| Verpakking | - | - | Koffer | Koffer | Koffer | Koffer | Koffer | Koffer |
| Gewicht | 3,0 - 3,7 kg | 3,0 - 3,7 kg | 4,4 - 5,4 kg | 4,4 - 5,4 kg | 4,4 - 5,4 kg | 4,6 - 7,4 kg | 4,6 - 7,4 kg | 4,6 - 7,4 kg |
| Prijs in € | excl. btw | | | | | | | |
| | incl. btw | | | | | | | |



CE001GZ

CE001G

- Uiterst krachtig dankzij 2x 40Vmax technologie
- Met soft start, AFT en elektrische rem
- Geïntegreerde watertoevoer
- XPT en Wetguard (IPX4) bescherming
- De combinatie van AVT technologie en een trillingsabsorberende behuizing zorgen voor een zeer laag vibratieniveau.



CE002GZ01

CE002G

- Versie zonder wateraansluiting, ontworpen voor droog zagen
- Met AWS & stofzuigaansluiting
- Incl. diamantschijf



PROMO:
GRATIS diamantschijf
355 mm E-12996
+ GRATIS BL4040F
na registratie op
www.makita.be
bij CE001GZ



NIEUW

OPTIONEEL ACCESSOIRE

trolley



PROMO:
GRATIS BL4040F
na registratie op
www.makita.be
bij CE002GZ01



| | CE001GZ | CE002GZ01 |
|--|---|---|
| Spanning | 72 V (80Vmax) | 72 V (80Vmax) |
| Bijgeleverde accu's/lader | - | - |
| Ø zaagblad | 355 mm | 355 mm |
| Toerental onbelast | 5300 min ⁻¹ | 4200 min ⁻¹ |
| Max. zaagdiepte | 127 mm | 127 mm |
| Trillingsniveau (ah) vooraan / achteraan | 2,5 m/s ² / 1,8 m/s ² | 2,5 m/s ² / 1,8 m/s ² |
| AWS | - | ✓ |
| Gewicht | 12,3 - 14,1 kg | 13,1 - 15,1 kg |
| Prijs in € | excl. btw | |
| | incl. btw | |

DIAMANTSCHIJVEN

| | Artikel | Ø | Dikte | Hoogte segment | Ø asgat | Reductiering | Prijs excl. btw | Prijs incl. btw |
|---------------|---------|--------|--------|----------------|----------|--------------|-----------------|-----------------|
| Quasar | B-12712 | 230 mm | 2,6 mm | 12 mm | 22,23 mm | 20 mm | | |
| | B-17588 | 300 mm | 3,0 mm | 12 mm | 25,4 mm | 20 mm | | |
| | B-13465 | 350 mm | 3,0 mm | 12 mm | 25,4 mm | 20 mm | | |
| | B-13471 | 400 mm | 3,0 mm | 12 mm | 25,4 mm | 20 mm | | |
| Comet | B-12784 | 230 mm | 2,6 mm | 12 mm | 22,23 mm | 20 mm | | |
| | B-17619 | 300 mm | 3,0 mm | 10 mm | 25,4 mm | 20 mm | | |
| | B-13552 | 350 mm | 3,0 mm | 10 mm | 25,4 mm | 20 mm | | |
| | B-13568 | 400 mm | 3,0 mm | 10 mm | 25,4 mm | 20 mm | | |
| Asfalt | B-13275 | 350 mm | 3,2 mm | 10 mm | 25,4 mm | 20 mm | | |
| | B-42905 | 400 mm | 3,2 mm | 10 mm | 25,4 mm | 20 mm | | |

| | Artikel | Ø extern | Ø intern | Dikte | Prijs excl. btw | Prijs incl. btw |
|-----------------------|----------|----------|----------|--------|-----------------|-----------------|
| Reductieringen | 257199-4 | 22,23 mm | 20,00 mm | 3,0 mm | | |
| | 197318-9 | 25,4 mm | 20,00 mm | 5 mm | | |

ACCU DOORSLIJPER 230MM



CE003GZ02

PROMO:
GRATIS BL4040F
na registratie op
www.makita.be
bij CE003GZ02

- Schijfdiameter 230 mm
- Zeer goede vermogen/gewichtsverhouding
- Voor het doorslijpen van metaal met abrasieve schijf of nat doorslijpen in steen of beton met diamantschijf.
- Met aansluiting voor waterslang
- Door het relatief lage gewicht en compacte bouw ideaal voor het slijpen in moeilijke situaties, bijvoorbeeld laag bij de grond of verticaal.
- Incl. doorslijpschijf voor metaal



| | | CE003GZ02 |
|------------------------------|-----------|----------------------------|
| Spanning | | 36 V (40Vmax) |
| Bijgeleverde accu's/lader | | - |
| Ø zaagblad | | 230 mm |
| Toerental onbelast | | 6600 min ⁻¹ |
| Max. zaagdiepte | | 88 mm |
| Trillingsniveau links/rechts | | 3,0 / 1,9 m/s ² |
| Gewicht | | 6,4 – 7,4 kg |
| Prijs in € | excl. btw | |
| | incl. btw | |

ACCU DOORSLIJPER 305MM



| | | CE004GZ |
|---------------------------|-----------|----------------------------|
| Spanning | | 36 V (40Vmax) |
| Bijgeleverde accu's/lader | | - |
| Ø zaagblad | | 305 mm |
| Toerental onbelast | | 5000 min ⁻¹ |
| Max. zaagdiepte | | 121 mm |
| Trillingsniveau (ah) | | 3,8 / 2,3 m/s ² |
| Gewicht | | 6,7 – 7,7 kg |
| Prijs in € | excl. btw | |
| | incl. btw | |

- Schijfdiameter 305 mm
- Zeer goede vermogen/gewichtsverhouding
- Voor het doorslijpen van metaal met abrasieve schijf of nat doorslijpen in steen of beton met diamantschijf.
- Met aansluiting voor waterslang



CE004GZ

PROMO:
GRATIS BL4040F
na registratie op
www.makita.be
bij CE004GZ



ACCU RECIPROZAGEN

BL MOTOR XGT **40V LITHIUM max**



JR002GM201



JR002G

- Vermogen vergelijkbaar met model op netstroom
- Met pendelmechanisme (JR002G)
- Zeer laag trillingsniveau dankzij AVT technologie
- Handige bladontgrendelingshendel en verstelbare aanslag
- Ledverlichting



JR001GD201



Gedempte ophanging

De accu en de behuizing zijn verbonden met trillingsabsorberende rubbers.

Gereedschapsloze aanpassing van de aanslag

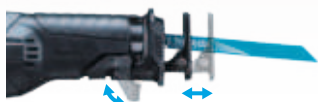

| | JR001GZ | JR001GD201 | JR001GM201 | JR002GZ | JR002GM201 |
|-----------------------|--|--|--|--|--|
| Spanning | 36 V (40Vmax) | 36 V (40Vmax) | 36 V (40Vmax) | 36 V (40Vmax) | 36 V (40Vmax) |
| Bijgeleverde accu's | 0 | 2 x BL4025 | 2 x BL4040 | - | 2 x BL4040 |
| Bijgeleverde lader | - | DC40RA | DC40RA | - | DC40RA |
| Slaglengte | 32 mm | 32 mm | 32 mm | 32 mm | 32 mm |
| Aantal zaagbewegingen | 0 - 2300 min ⁻¹ 0 - 3000 min ⁻¹ | 0 - 2300 min ⁻¹ 0 - 3000 min ⁻¹ | 0 - 2300 min ⁻¹ 0 - 3000 min ⁻¹ | 0 - 3000 min ⁻¹ 0 - 3000 min ⁻¹ | 0 - 3000 min ⁻¹ 0 - 3000 min ⁻¹ |
| Pendelinstelling | - | - | - | ✓ | ✓ |
| AVT | - | - | - | ✓ | ✓ |
| Gewicht | 4,2 - 4,5 kg | 4,2 - 4,5 kg | 4,2 - 4,5 kg | 4,6 - 5,8 kg | 4,6 - 5,8 kg |
| Prijs in € | excl. btw | | | | |
| | incl. btw | | | | |

ACCU BANDZAGEN

BL MOTOR XGT **40V LITHIUM max**



PB002GM201

- Grote zaagcapaciteit tot Ø127 mm
- Variabele snelheidsregeling
- Hoge bandsnelheid
- Gemakkelijke spoorverstelling

| | PB002GZ | PB002GM201 |
|---------------------|--------------------|--------------------|
| Spanning | 36 V (40Vmax) | 36 V (40Vmax) |
| Bijgeleverde accu's | - | 2x BL4040 |
| Bijgeleverde lader | - | DC40RA |
| Zaagcapaciteit | 127 x 127 mm | 127 x 127 mm |
| Zaaglint | 1140 x 13 x 0,5 mm | 1140 x 13 x 0,5 mm |
| Gewicht | 6,6 - 7,8 kg | 6,6 - 7,8 kg |
| Prijs in € | excl. btw | |
| | incl. btw | |

ACCU POLIJSTMACHINE

BL MOTOR XGT **40V LITHIUM max**



PV001GM101



| | PV001GZ | PV001GM101 |
|---------------------|----------------------------|----------------------------|
| Spanning | 36 V (40Vmax) | 36 V (40Vmax) |
| Bijgeleverde accu's | - | 1x BL4040 |
| Bijgeleverde lader | - | DC40RA |
| Diameter | 180 mm | 180 mm |
| Toerental onbelast | 0 - 2200 min ⁻¹ | 0 - 2200 min ⁻¹ |
| Gewicht | 3,2 - 3,9 kg | 3,2 - 3,9 kg |
| Prijs in € | excl. btw | |
| | incl. btw | |

ACCU MULTITOOL



TM001GZ

TM001G

- Compatibel met STARLOCK, STARLOCK PLUS en STARLOCK Max accessoires
- Grote oscillatiehoek van 3,6°
- Uiterst lage trillingswaarden dankzij AVT technologie
- Variabele snelheidsregeling
- Versie TM001GZ03: inclusief 32 accessoires

| | | TM001GZ02 | TM001GZ03 |
|----------------------|-----------|---------------------------------------|---------------------------------------|
| Spanning | | 36 V (40Vmax) | 36 V (40Vmax) |
| Bijgeleverde accu's | | - | - |
| BL motor | | ✓ | ✓ |
| Oscillatiefrequentie | | 10000-20000 /min | 10000-20000 /min |
| Oscillatiehoek | | 3,6 ° | 3,6 ° |
| Opname | | Starlock, Starlock Plus, Starlock Max | Starlock, Starlock Plus, Starlock Max |
| Gewicht | | 2,0 kg | 2,0 kg |
| Prijs in € | excl. btw | | |
| | incl. btw | | |

STARLOCK



STARLOCK PLUS



STARLOCK MAX



Voor het volledig overzicht van het assortiment scan hier

- ✓ Snelle wissel van accessoires door een simpele klik
- ✓ Starlock Plus zaagbladen : snel, diep en veelzijdig invallend zagen
- ✓ Starlock Max zaagbladen : zelfs voor de meest veeleisende en zware toepassingen

Starlock Plus en Starlock Max accessoires kunnen enkel gebruikt worden met de DTM52.

ACCU SCHAAF



- Even krachtig als een machine op netstroom
- Kan tot 4,0 mm in één passage schaven
- Spaanders kunnen links of rechts uitgeworpen worden
- Zool met 3 groeven voor het afschuiven van kanten
- Sponningsdiepte tot 25 mm



KP001GM202

| | | KP001GZ01 | KP001GM202 |
|---------------------|-----------|-------------------------|-------------------------|
| Spanning | | 36 V (40Vmax) | 36 V (40Vmax) |
| Bijgeleverde accu's | | - | 2x BL4040 |
| Bijgeleverde lader | | - | DC40RA |
| Toerental onbelast | | 15000 min ⁻¹ | 15000 min ⁻¹ |
| Schaafbreedte | | 82 mm | 82 mm |
| Max. spaanafname | | 4,0 mm | 4,0 mm |
| AWS | | ✓ | ✓ |
| Gewicht | | 3,7 - 4,9 kg | 3,7 - 4,9 kg |
| Prijs in € | excl. btw | | |
| | incl. btw | | |

ACCU INVALCIRKELZAAG

MAK
PAC

BL
MOTOR

XGT
40V
Li-ion
max



SP001GZ03



AWS compatibel
Voor het draadloos aansturen van een AWS compatibele stofzuiger.
(incl. Bluetooth unit)

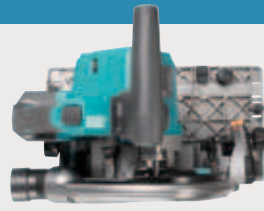

Compact en licht, perfect uitgebalanceerd.
Door het gebruik van slechts één 40Vmax accu en magnesium componenten.



Grote zaagcapaciteit
Zaagdiepte van 56 mm bij 90° en een kantelbereik van -1 tot 48°.



Perfekte geleiding
De magnesium zool past rechtstreeks op een geleiderail.

SP001GZ03

| | |
|---------------------|-------------------------------|
| Spanning | 36 V (40Vmax) |
| Bijgeleverde accu's | - |
| Ø zaagblad | 165 mm |
| Toerental onbelast | 2500 - 4900 min ⁻¹ |
| Zaagdiepte (90°) | 56 mm |
| AWS | ✓ |
| Gewicht | 4,4 - 5,0 kg |
| Prijs in € | excl. btw |
| | incl. btw |

ACCU DECOUPEERZAGEN

BL
MOTOR

XGT
40V
Li-ion
max

JV001G/ JV002G

- 3 pendelinstellingen + recht snijden
- Brede basisplaat voor uitstekende stabiliteit
- De soft-no-load functie verlaagt het toerental bij lage belasting
- JV002G: model met beugelgreep



JV002GZ



JV001GZ01

OPTIONEEL ACCESSOIRE

Voor een snelle en perfecte afwerking bij het zagen van dikker plaatmateriaal en bij golvende lijnen

| Referentie | Totale lengte | Werk-lengte | TPI | Blad-dikte | Toepassing | Prijs excl. btw | Prijs incl. btw | stuks/verpakking |
|------------|---------------|-------------|-----|------------|------------------|-----------------|-----------------|------------------|
| E-22218 | 105mm | 80mm | 9 | 1.5 mm | Hout / Kunststof | | | 5 |



| | JV001GZ01 | JV001GM201 | JV002GZ |
|-----------------------|------------------------------|------------------------------|------------------------------|
| Spanning | 36 V (40Vmax) | 36 V (40Vmax) | 36 V (40Vmax) |
| Bijgeleverde accu's | - | 2x BL4040 | - |
| Bijgeleverde lader | - | DC40RA | - |
| Aantal zaagbewegingen | 800 - 3500 min ⁻¹ | 800 - 3500 min ⁻¹ | 800 - 3500 min ⁻¹ |
| Max. capaciteit hout | 135 mm | 135 mm | 135 mm |
| Slaglengte | 26 mm | 26 mm | 26 mm |
| Gewicht | 2,6 - 2,9 kg | 2,6 - 2,9 kg | 2,7 - 3,0 kg |
| Verpakking | Makpac | Makpac | Doos |
| Prijs in € | excl. btw | | |
| | incl. btw | | |

XGT COMBOKIT

MAK
PAC

BL
MOTOR

XGT
40V
Li-ion
max



SP001G

JV001G

BL4040

DC40RA

DK0228G201

| | |
|------------------------|---------------|
| Spanning | 36 V (40Vmax) |
| Bijgeleverde accu's | 2x BL4040 |
| Bijgeleverde lader | DC40RA |
| Invalcirkelzaag 165 mm | SP001G |
| Decoupeerzaag | JV001G |
| Verpakking | Makpac |
| Prijs in € | excl. btw |
| | incl. btw |

199141-8

NEXT GENERATION TECHNOLOGY



ACCU CIRKELZAGEN

BL
MOTOR

AWS
Auto-start Wireless System

XGT
40V LITHIUM
max

HS012GZ

- Bijzonder krachtige accucirkelzaag met links geplaatst zaagblad.
- Compact, licht en perfect uitgebalanceerd dankzij de nieuw ontwikkelde BL motor.
- Diepteregeling met duidelijk afleesbare schaal en kantelbaar tot 45°.
- De zool en beschermkap zijn uitgevoerd in hoogwaardig magnesium.
- Opgelet deze machine past niet rechtstreeks op een geleiderail.



HS009GT201



HS012GZ01



HS003GM201



HS013GZ

HS013GZ

- Uitstekende wendbaarheid
- Hoog vermogen vergelijkbaar met een gesnoerd model
- Zeer grote zaagcapaciteit van 158 mm (45°: 106 mm)
- Uiterst efficiënt dankzij BL motor met hoog koppel en Efficut cirkelzaagblad



Met standaard in kunststof om de machine gemakkelijk neer te zetten en op te bergen.



Zaagt dikke balken in één passage met een kracht die vergelijkbaar is met gesnoerde machines.

NIEUW

| | HS012GZ01 | HS003GZ | HS003GM201 | HS004GZ | HS004GZ01 | HS004GM202 | HS009GZ | HS009GT201 | HS010GZ | HS010GT201 | HS011GZ | HS013GZ |
|-----------------------------|----------------------|----------------------|----------------------|----------------------|---------------|---------------|----------------------|----------------------|----------------------|----------------------|----------------------|----------------------|
| Spanning | 36 V (40Vmax) | 36 V (40Vmax) | 36 V (40Vmax) | 36 V (40Vmax) | 36 V (40Vmax) | 36 V (40Vmax) | 36 V (40Vmax) | 36 V (40Vmax) | 36 V (40Vmax) | 36 V (40Vmax) | 36 V (40Vmax) | 36 V (40Vmax) |
| Bijgeleverde accu's | - | - | 2 x BL4040 | - | - | 2 x BL4040 | - | 2x BL4050F | - | 2x BL4050F | - | - |
| Bijgeleverde lader | - | - | DC40RA | - | - | DC40RA | - | DC40RA | - | DC40RA | - | - |
| Ø zaagblad | 165 mm | 190 mm | 190 mm | 190 mm | 190 mm | 190 mm | 235 mm | 235 mm | 235 mm | 235 mm | 270 mm | 415 mm |
| Zaagdiepte (90°) | 57 mm | 68,5 mm | 68,5 mm | 62,5 mm | 62,5 mm | 62,5 mm | 85 mm | 85 mm | 85 mm | 85 mm | 101 mm | 158 mm |
| Rechtstreeks op geleiderail | - | - | - | ✓ | ✓ | ✓ | ✓ | ✓ | - | - | ✓ | - |
| AWS | ✓ | ✓ | ✓ | ✓ | ✓ | ✓ | ✓ | ✓ | ✓ | ✓ | ✓ | ✓ |
| | excl. Bluetooth unit | excl. Bluetooth unit | excl. Bluetooth unit | excl. Bluetooth unit | | | excl. Bluetooth unit | excl. Bluetooth unit | excl. Bluetooth unit | excl. Bluetooth unit | excl. Bluetooth unit | excl. Bluetooth unit |
| Verpakking | Makpac | - | Makpac | - | - | Makpac | - | Koffer | - | Koffer | - | - |
| Gewicht | 3,2 - 4,4kg | 4,1 - 4,4 kg | 4,1 - 4,4 kg | 4,4 - 4,7 kg | 4,4 - 4,7 kg | 4,4 - 4,7 kg | 5,1 - 5,7 kg | 5,1 - 5,7 kg | 6,0 - 6,4 kg | 6,0 - 6,4 kg | 5,5 - 6,7 kg | 11,0 - 12,0 kg |
| Prijs in € | | | | | | | | | | | | |
| | excl. btw | | | | | | | | | | | |
| | incl. btw | | | | | | | | | | | |

ACCU CIRKELZAGEN MET ACHTERHANDGREEP

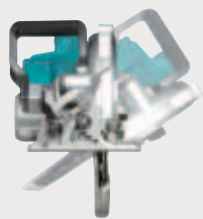

RS001GM101

RS001G / RS002G

- Speciaal ontwerp met handgreep achteraan
- Krachtig en licht (magnesium zool)



| | RS001GZ | RS001GM101 | RS002GZ |
|---------------------|------------------------|------------------------|---------------------------|
| Spanning | 36 V (40Vmax) | 36 V (40Vmax) | 36 V (40Vmax) |
| Bijgeleverde accu's | 0 | 1 x BL4040 | 0 |
| Zaagdiepte (90°) | 65 mm | 65 mm | 95 mm |
| Ø zaagblad | 185 mm | 185 mm | 260 mm |
| AWS | - | - | ✓ excl. Bluetooth unit |
| Toerental onbelast | 6400 min ⁻¹ | 6400 min ⁻¹ | 4000 min ⁻¹ |
| Gewicht | 5,0 - 5,6 kg | 5,0 - 5,6 kg | 5,7 - 6,3 kg |
| Prijs in € | excl. btw | | |
| | incl. btw | | |

ACCU TELESCOPISCHE AFKORT - VERSTEKZAGEN



Belangrijke bedieningsknoppen zijn vooraan geplaatst



LS002GZ01

Promo:
gratis onderstel DEBWST06
t.w.v.



Uitschuifbare zijsteunen

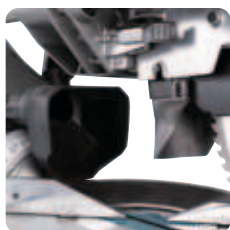

Efficiënte stofafzuiging

De geoptimaliseerde stofafzuiging met twee poorten garandeert een perfecte stofafzuiging, ook bij het zagen van dunne planken.

Kantelhoek 48°
links en rechts



Aanduiding van de zaaglijn

Een led lamp werpt de schaduw van het zaagblad op het werkstuk, deze aanduiding is onder alle omstandigheden exact.

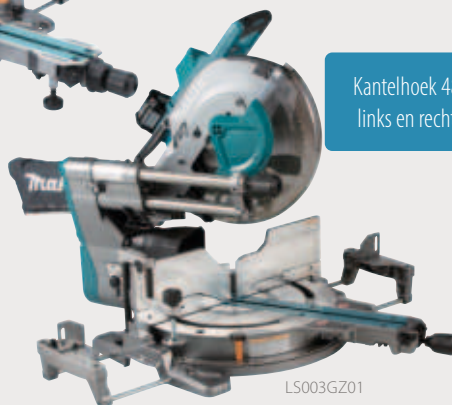

LS003GZ01

DXT

Deep and Exact Cutting Technology

De gepatenteerde constructie met drieduidige tandwieloverbrenging en uitsparing achter de flens laat toe om een groter deel van het zaagblad te benutten. Daardoor kunnen ook hoge plinten verticaal of in verstek afgekort worden.



Manuele bediening

De afzuiging kan via een schakelaar ook manueel gestart worden (via Bluetooth), dit is ook handig om de machine schoon te maken.

| | LS002GZ01 | LS004GZ01 | LS003GZ01 |
|---------------------|------------------------|------------------------|------------------------|
| Spanning | 36 V (40Vmax) | 36 V (40Vmax) | 36 V (40Vmax) |
| Bijgeleverde accu's | 0 | 0 | 0 |
| Ø zaagblad | 216 mm | 260 mm | 305 mm |
| Verstekhoek | 60 L / 60 R | 60° L / 60° R | 60 L / 60 R |
| Kantelhoek | 48° L / 48° R | 48° L / 48° R | 48° L / 48° R |
| Toerental onbelast | 4800 min ⁻¹ | 3600 min ⁻¹ | 3600 min ⁻¹ |
| Capaciteit | 70 x 312 mm | 91 x 312 mm | 107 x 312 mm |
| AWS | ✓ | ✓ | ✓ |
| DXT | ✓ | ✓ | ✓ |
| Gewicht | 16,4 - 17,0 kg | 26,6 - 27,2 kg | 30,5 - 31,1 kg |
| Prijs in € | excl. btw | | |
| | incl. btw | | |

NEXT GENERATION TECHNOLOGY

ACCU BOVEN- EN KANTENFREES



- Compact en flexibel systeem
- Zeer hoog vermogen dankzij 40Vmax technologie
- Zachte rem
- Verschillende hulpstukken meegeleverd

RT001GM208

| | | RT001GZ16 | RT001GM208 |
|-------------------------|-----------|-------------------------------|-------------------------------|
| Spanning | | 36 V (40Vmax) | 36 V (40Vmax) |
| Bijgeleverde accu's | | - | 2x BL4040 |
| Bijgeleverde lader | | - | DC40RA |
| Toerental onbelast | | 10000-31000 min ⁻¹ | 10000-31000 min ⁻¹ |
| Max. indukdiepte | | 40 mm | 40 mm |
| Ø spantang - bereik | | 6 - 8 mm | 6 - 8 mm |
| Ø spantang - inbegrepen | | 6 mm, 8 mm | 6 mm, 8 mm |
| AWS | | ✓ excl. Bluetooth unit | ✓ excl. Bluetooth unit |
| Gewicht | | 2,2 - 2,5 kg | 2,2 - 2,5 kg |
| Prijs in € | excl. btw | | |
| | incl. btw | | |

ACCU BOVENFREES



RP001G

- Even krachtig dan een gesnoerd model dankzij 40Vmax technologie
- Licht en compact; gemakkelijk te hanteren
- Beperkte hoogte van amper 228 mm



Dankzij een speciaal ontwikkelde motor en een efficiënte koeling is de machine uiterst krachtig en tegelijkertijd compact

RP001GZ02

| | | |
|-------------------------|-----------|--------------------------------|
| Spanning | | 36 V (40Vmax) |
| Bijgeleverde accu's | | - |
| Max. indukdiepte | | 60 mm |
| Toerental onbelast | | 8000 - 25000 min ⁻¹ |
| Ø spantang - bereik | | 6 - 12 mm |
| Ø spantang - inbegrepen | | 6 mm, 8 mm |
| AWS | | ✓ excl. Bluetooth unit |
| Gewicht | | 4,0 - 5,2 kg |
| Prijs in € | excl. btw | |
| | incl. btw | |

ACCESSOIRES







D-78318
22-delige frezenset (6 mm)



D-74778
22-delige frezenset (8 mm)

SCHUURNETTEN

| Afmeting | Korrel | Omschrijving | Artikelnummer | Verpakt per | Prijs excl. btw | Prijs incl. btw |
|--------------------|---|---------------|---------------|-------------|-----------------|-----------------|
| 125 mm |  | K80 | Schuurnet | D-78651 | 10 | |
| | | K120 | Schuurnet | D-78667 | 10 | |
| | | K180 | Schuurnet | D-78673 | 10 | |
| | | K240 | Schuurnet | D-78689 | 10 | |
| | | K320 | Schuurnet | D-78695 | 10 | |
| | | Padbeschermer | D-78704 | 2 | | |
| 150 mm |  | K80 | Schuurnet | D-78710 | 10 | |
| | | K120 | Schuurnet | D-78726 | 10 | |
| | | K180 | Schuurnet | D-78732 | 10 | |
| | | K240 | Schuurnet | D-78748 | 10 | |
| | | K320 | Schuurnet | D-78754 | 10 | |
| | | Padbeschermer | D-78760 | 2 | | |
| 80 mm x 130 mm |  | K80 | Schuurnet | D-78776 | 10 | |
| | | K120 | Schuurnet | D-78782 | 10 | |
| | | K180 | Schuurnet | D-78798 | 10 | |
| | | K240 | Schuurnet | D-78807 | 10 | |
| | | K320 | Schuurnet | D-78813 | 10 | |
| | | Padbeschermer | D-78829 | 2 | | |
| 93 mm x 185 mm |  | K80 | Schuurnet | D-78835 | 10 | |
| | | K120 | Schuurnet | D-78841 | 10 | |
| | | K180 | Schuurnet | D-78857 | 10 | |
| | | K240 | Schuurnet | D-78863 | 10 | |
| | | K320 | Schuurnet | D-78879 | 10 | |
| | | Padbeschermer | D-78885 | 2 | | |
| 100 mm x 150 mm |  | K80 | Schuurnet | D-78891 | 10 | |
| | | K120 | Schuurnet | D-78900 | 10 | |
| | | K180 | Schuurnet | D-78916 | 10 | |
| | | K240 | Schuurnet | D-78922 | 10 | |
| | | K320 | Schuurnet | D-78938 | 10 | |
| | | Padbeschermer | D-78944 | 2 | | |

- De netstructuur zorgt voor een zeer hoge efficiëntie bij het schuren!
- Optimale stofafzuiging via de netstructuur!
- Uiterst gemakkelijk te installeren in combinatie met de velcro padbeschermer

ACCU BANDSCHUURMACHINE



Kan ook ondersteboven, als stationaire machine gebruikt worden (klemmen- en parallelgeleiderset afzonderlijk verkrijgbaar)

BS001GZ

- Hoog vermogen vergelijkbaar met model met snoer
- Perfect uitgebalanceerd en laag zwaartepunt
- Draaibare handgreep
- Stofzak met handige connector en vergrendeling
- Automatische aanpassing van de bandposititie
- Verstelbare ledlamp



Vlakke rechterzijde om tot tegen een wand te kunnen schuren



BS001GZ

NIEUW

BS001GZ

| | |
|---------------------|-----------------------|
| Spanning | 36 V (40V/max) |
| Bijgeleverde accu's | - |
| Bijgeleverde lader | - |
| Bandsnelheid | 120 - 470 m/min |
| Schuurband | 76 x 533 mm |
| AWS | ✓excl. Bluetooth unit |
| Gewicht | 4,5 - 5,1 kg |
| Prijs in € | excl. btw |
| | incl. btw |

NEXT GENERATION TECHNOLOGY

EXCENTER ACCUSCHUURMACHINES

BL XGT **40V** LITHIUM max **MOTOR**



BO002CGZ



BO004CGZ



BO005CGZ



BO006CGZ



BO007CGZ



- Speciaal ontwerp met handgreep achteraan
- Uiterst compact en licht; de batterij is via een kabel verbonden met de machine.
- Laag zwaartepunt en optimaal uitgebalanceerde machine. Dit resulteert in een aangenaam, natuurlijk handgevoel bij delicaat schuurwerk.
- De machine is via een connector gemakkelijk te koppelen, zo kan snel geschakeld worden tussen verschillende machines aangepast aan elke toepassing.
- Stofopvang d.m.v. het ingebouwd stofopvangsysteem met stofzak of door aansluiting van een stofzuiger.
- Compatibel met een nieuwe reeks schuur schijven van het gaastype.



Gemakkelijke aansluiting van de voedingskabel via een connector



BO001CG en BO002CG zijn met een schuuruitslag van 5 mm hoogst efficiënt



Een padbeschermers beperkt de slijtage van de schuurzool zodat deze langer mee gaat.

NIEUW

| | BO001CGZ | BO002CGZ | BO003CGZ | BO004CGZ | BO005CGZ | BO006CGZ | BO007CGZ |
|---------------------|--------------------------------|--------------------------------|--------------------------------|--------------------------------|--------------------------------|--------------------------------|--------------------------------|
| Spanning | 36 V (40Vmax) | 36 V (40Vmax) | 36 V (40Vmax) | 36 V (40Vmax) | 36 V (40Vmax) | 36 V (40Vmax) | 36 V (40Vmax) |
| Bijgeleverde accu's | - | - | - | - | - | - | - |
| Bijgeleverde lader | - | - | - | - | - | - | - |
| Schuurzool | Ø 125 mm | Ø 150 mm | Ø 125 mm | Ø 150 mm | Rechthoekig 80 x 130 mm | Delta 100 x 150 mm | Rechthoekig 93 x 185 mm |
| Schuurbewegingen | 6000 - 10000 min ⁻¹ | 6000 - 10000 min ⁻¹ | 6000 - 10000 min ⁻¹ | 6000 - 10000 min ⁻¹ | 6000 - 10000 min ⁻¹ | 6000 - 10000 min ⁻¹ | 6000 - 12000 min ⁻¹ |
| Schuuruitslag | 5 mm | 5 mm | 3 mm | 3 mm | 3 mm | 3 mm | 2 mm |
| Vibratieniveau | 3,2 m/s ² | 2,7 m/s ² | 2,9 m/s ² | 2,5 m/s ² | 2,6 m/s ² | 2,6 m/s ² | 3,1 m/s ² |
| AWS | ✓excl. Bluetooth unit | ✓excl. Bluetooth unit | ✓excl. Bluetooth unit | ✓excl. Bluetooth unit | ✓excl. Bluetooth unit | ✓excl. Bluetooth unit | ✓excl. Bluetooth unit |
| Gewicht | 0,92 kg | 0,98 kg | 0,91 kg | 0,96 kg | 0,93 kg | 0,93 kg | 1,10 kg |
| Prijs in € | excl. btw | | | | | | |
| | incl. btw | | | | | | |

ACCU MINIBRADPISTOOL 18 GA



| | FN001GZ02 | FN001GA202 |
|---------------------|---------------|---------------|
| Spanning | 36 V (40Vmax) | 36 V (40Vmax) |
| Bijgeleverde accu's | - | 2x BL4020 |
| Bijgeleverde lader | - | DC40RA |
| Lengte nagels | 15 - 40 mm | 15 - 40 mm |
| Capaciteit magazijn | 100 | 100 |
| Makpac | ✓ | ✓ |
| Gewicht | 2.6 - 3.2 kg | 2.6 - 3.2 kg |
| Prijs in € | excl. btw | |
| | incl. btw | |

ACCU AFWERKINGSPISTOOL 23 GA



- Werkt sneller dankzij BL motor en herontworpen indrijvingsveer
- Mechanisme met bewegend tegengewicht voor lage terugslag

| | PT001GZ01 | PT001GD101 |
|---------------------|---------------|---------------|
| Spanning | 36 V (40Vmax) | 36 V (40Vmax) |
| Bijgeleverde accu's | - | 1x BL4025 |
| Bijgeleverde lader | - | DC40RA |
| Lengte nagels | 15 - 35 mm | 15 - 35 mm |
| Capaciteit magazijn | 120 | 120 |
| Makpac | ✓ | ✓ |
| Gewicht | 2.4 - 3.0 kg | 2.4 - 3.0 kg |
| Prijs in € | excl. btw | |
| | incl. btw | |



COMPRESSOR



| | AC001GZ |
|---------------------|--------------------|
| Spanning | 36V (40Vmax) |
| Bijgeleverde accu's | - |
| Debiet | 34 l/min @ 6,0 bar |
| Inschakeldruk | 7,2 bar |
| Uitschakeldruk | 9,4 bar |
| Uitgangsdruk | 0 - 9,3 bar |
| Geluidsdrukkniveau | 68 dB(A) |
| Tankinhoud | 7,6 L |
| Gewicht | 10,1 - 12,8 kg |
| Prijs in € | excl. btw |
| | incl. btw |

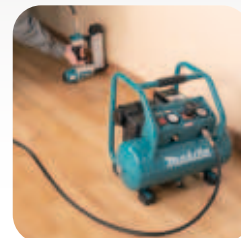
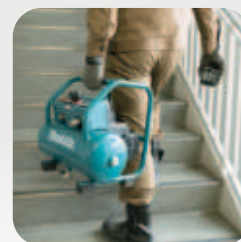



PP001GZK

- Uiterst krachtig en hoge ponsnelheid dankzij borstelloze motor in combinatie met XGT.
- Zeer compact ontwerp.
- 360° draaibaar motorgedeelte
- Hengel voor handmatige terugkeer

NIEUW

PP001GZK

| | |
|-----------------------|----------------|
| Spanning | 36 V (40Vmax) |
| Bijgeleverde accu's | - |
| Bijgeleverde lader | - |
| Max. diameter ponsgat | 20 mm |
| Inbegrepen Ø | 14 mm |
| Max. dikte staal | 9 mm |
| Max. dikte inox | 6 mm |
| Gewicht | 11,6 - 12,8 kg |
| Prijs in € | excl. btw |
| | incl. btw |

COMBOPACK XGT



DK0114G205

| | |
|-----------------------------|------------|
| Bijgeleverde accu's | 2 x BL4040 |
| Bijgeleverde lader | DC40RA |
| Klopboor- en schroefmachine | HP001G |
| Slagschroevendraaier | TD001G |
| Verpakking | Makpac |
| Prijs in € | excl. btw |
| | incl. btw |

COMBOPACK XGT



Promo:
gratis accu 2,5 Ah
BL4025

DK0124G201

| | |
|-------------------------|------------|
| Bijgeleverde accu's | 2 x BL4040 |
| Bijgeleverde lader | DC40RA |
| Boor- en schroefmachine | DF001G |
| Haakse slijper 125 mm | GA005G |
| Verpakking | Makpac |
| Prijs in € | excl. btw |
| | incl. btw |

COMBOPACK XGT



Promo:
Gratis accu 4,0 Ah
BL4040

DK0125G301

| | |
|-------------------------|------------|
| Bijgeleverde accu's | 2 x BL4040 |
| Bijgeleverde lader | DC40RA |
| Boor- en schroefmachine | DF001G |
| Slagschroevendraaier | TD001G |
| Haakse slijper 125 mm | GA005G |
| Verpakking | Makpac |
| Prijs in € | excl. btw |
| | incl. btw |

NEXT GENERATION TECHNOLOGY

COMBOPACK XGT

MAK
PAC

XGT
40V
Lithium
max



DK0229G401

| | |
|-------------------------|------------|
| Meegeleverde batterijen | 3 x BL4040 |
| Bijgeleverde lader | DC40RA |
| Boor- en schroefmachine | DF001G |
| Slagschroevendraaier | TD001G |
| Combihamer SDS-PLUS | HR002G |
| Haakse slijper 125 mm | GA005G |
| Verpakking | Makpac |
| Prijs in € | excl. btw |
| | incl. btw |

COMBOPACK XGT

XGT
40V
Lithium
max



DK0230G601

| | |
|-------------------------|------------|
| Bijgeleverde accu's | 4 x BL4040 |
| Bijgeleverde lader | DC40RA |
| Boor- en schroefmachine | DF001G |
| Slagschroevendraaier | TD001G |
| Combihamer SDS-PLUS | HR002G |
| Haakse slijper 125 mm | GA005G |
| Decoupeerzaag | JV001G |
| Cirkelzaag | HS003G |
| Verpakking | makpac |
| Prijs in € | excl. btw |
| | incl. btw |

XGT-PLATFORM

AS001GZ

Blaas- en zuigmachine 40Vmax

Prijs excl. BTW

Prijs incl. BTW



BO001CGZ

Excenter schuurmachine 40Vmax 125mm, 3mm uitslag

Prijs excl. BTW

Prijs incl. BTW



BO002CGZ

Excenter schuurmachine 40Vmax 150mm, 3mm uitslag

Prijs excl. BTW

Prijs incl. BTW



BO003CGZ

Excenter schuurmachine 40Vmax 125mm, 5mm uitslag

Prijs excl. BTW

Prijs incl. BTW



BO004CGZ

Excenter schuurmachine 40Vmax 150mm, 5mm uitslag

Prijs excl. BTW

Prijs incl. BTW



BO005CGZ

Excenter schuurmachine 40Vmax 80x130mm

Prijs excl. BTW

Prijs incl. BTW



BO006CGZ

Excenter schuurmachine 40Vmax 100x150mm

Prijs excl. BTW

Prijs incl. BTW



BO007CGZ

Excenter schuurmachine 40Vmax 93x185mm

Prijs excl. BTW

Prijs incl. BTW



NIEUW

CE001GZ

Accu doorslijper 355 mm

Prijs excl. BTW

Prijs incl. BTW



CE002GZ01

Accu doorslijper 355 mm

Prijs excl. BTW

Prijs incl. BTW



CE003GZ02

Doorslijper 235 mm

Prijs excl. BTW

Prijs incl. BTW



CE004GZ

Doorslijper 305 mm

Prijs excl. BTW

Prijs incl. BTW



CF002GZ

Ventilator 40Vmax

Prijs excl. BTW

Prijs incl. BTW



CL001GZ05

Steelfstofzuiger 40Vmax

Prijs excl. BTW

Prijs incl. BTW



CL002GZ03

Steelfstofzuiger 40Vmax

Prijs excl. BTW

Prijs incl. BTW



CL002GZ07

Steelfstofzuiger 40Vmax

Prijs excl. BTW

Prijs incl. BTW



CL003GZ04

Steelfstofzuiger 40Vmax

Prijs excl. BTW

Prijs incl. BTW



CS002GZ

Metaalcirkelzaag

Prijs excl. BTW

Prijs incl. BTW



DA001GZ01

Haakse boormachine 40Vmax

Prijs excl. BTW

Prijs incl. BTW



DF001GZ01

Boor- en schroefmachine

Prijs excl. BTW

Prijs incl. BTW



DF002GZ01

Boor- en schroefmachine 40Vmax

Prijs excl. BTW

Prijs incl. BTW



FN001GZ02

Minibradpistool

Prijs excl. BTW

Prijs incl. BTW



GA013GZ01

Haakse slijper 125 mm

Prijs excl. BTW

Prijs incl. BTW



GA029GZ

Haakse slijper 125 mm

Prijs excl. BTW

Prijs incl. BTW



GA038GZ01

Haakse slijper 230 mm

Prijs excl. BTW

Prijs incl. BTW



GA041GZ

X-Lock haakse slijper 125 mm

Prijs excl. BTW

Prijs incl. BTW



HM004GZ01

Breekhamer 80V

Prijs excl. BTW

Prijs incl. BTW



HP001GZ01

Klopboor- en schroefmachine 40Vmax

Prijs excl. BTW

Prijs incl. BTW



HP002GZ01

Klopboor- en schroefmachine 40Vmax

Prijs excl. BTW

Prijs incl. BTW



HR001GZ

SDS-PLUS Combihamer 40Vmax

Prijs excl. BTW

Prijs incl. BTW



HR005GZ01

SDS-Max Combihamer 40Vmax

Prijs excl. BTW

Prijs incl. BTW



HR006GZ

SDS-Max Combihamer 40Vmax

Prijs excl. BTW

Prijs incl. BTW



HR007GZ01

SDS-PLUS Combihamer 40Vmax

Prijs excl. BTW

Prijs incl. BTW



HR009GZ02

SDS-PLUS Combihamer 40Vmax

Prijs excl. BTW

Prijs incl. BTW



HS004GZ

Cirkelzaag 190 mm

Prijs excl. BTW

Prijs incl. BTW



HS009GZ

Cirkelzaag 190 mm

Prijs excl. BTW

Prijs incl. BTW



HS010GZ

Cirkelzaag 235 mm

Prijs excl. BTW

Prijs incl. BTW



HS011GZ

Cirkelzaag 270 mm

Prijs excl. BTW

Prijs incl. BTW



HS012GZ01

Cirkelzaag 165 mm
40Vmax
Prijs excl. BTW
Prijs incl. BTW



MP001GZ

Luchtpomp
Prijs excl. BTW
Prijs incl. BTW



SP001GZ01

Invalcirkelzaag
Prijs excl. BTW
Prijs incl. BTW



TW009GZ01

Slagmoersleutel 40Vmax
Prijs excl. BTW
Prijs incl. BTW
beschikbaar vanaf juli



NIEUW

JR001GZ

Reciprozaag 40Vmax
Prijs excl. BTW
Prijs incl. BTW



PB002GZ

Bandzaag 40Vmax
Prijs excl. BTW
Prijs incl. BTW



TD003GZ01

Slagschroevendraaier 40Vmax
Prijs excl. BTW
Prijs incl. BTW



TW010GZ01

Slagmoersleutel 40Vmax
Prijs excl. BTW
Prijs incl. BTW



NIEUW

JR002GZ

Reciprozaag 40Vmax
Prijs excl. BTW
Prijs incl. BTW



PT001GZ01

Pinpistool 40Vmax
Prijs excl. BTW
Prijs incl. BTW



TM001GZ02

Multitool 40Vmax
Prijs excl. BTW
Prijs incl. BTW



UT001GZ01

Menger 40Vmax
Prijs excl. BTW
Prijs incl. BTW



KP001GZ01

Schaaf 40Vmax
Prijs excl. BTW
Prijs incl. BTW



PV001GZ

Polijschijf 40Vmax
Prijs excl. BTW
Prijs incl. BTW



TM001GZ03

Multitool 40Vmax
Prijs excl. BTW
Prijs incl. BTW



VC002GLZ01

Stofzuiger 40Vmax
Prijs excl. BTW
Prijs incl. BTW



KT001GZ

Waterkoker
Prijs excl. BTW
Prijs incl. BTW



RP001GZ

Accu bovenfrees
Prijs excl. BTW
Prijs incl. BTW



TW001GZ01

Slagmoersleutel 40Vmax
Prijs excl. BTW
Prijs incl. BTW



VC003GLZ

Stofzuiger 40Vmax
Prijs excl. BTW
Prijs incl. BTW



LS002GZ01

Radiale afkort-
zaag 40Vmax
Prijs excl. BTW
Prijs incl. BTW



RS001GZ

Wormzaag 185 mm
Prijs excl. BTW
Prijs incl. BTW



TW002GZ

Slagmoersleutel 40Vmax
Prijs excl. BTW
Prijs incl. BTW



VC005GLZ

Stofzuiger 40Vmax
Prijs excl. BTW
Prijs incl. BTW



LS003GZ01

Accu afkort- vers-
zaag 40Vmax
Prijs excl. BTW
Prijs incl. BTW



RS002GZ

Wormzaag 260 mm
Prijs excl. BTW
Prijs incl. BTW



TW004GZ01

Slagmoersleutel 40Vmax
Prijs excl. BTW
Prijs incl. BTW



VR003GZ

Betontriemaal 40Vmax
Prijs excl. BTW
Prijs incl. BTW



LS004GZ01

Accu afkort- vers-
zaag XGT
Prijs excl. BTW
Prijs incl. BTW



RT001GZ16

Boven- en kantenfrees
Prijs excl. BTW
Prijs incl. BTW



TW007GZ01

Slagmoersleutel 40Vmax
Prijs excl. BTW
Prijs incl. BTW



VR004GZ

Betontriemaal 40Vmax
Prijs excl. BTW
Prijs incl. BTW



191L77-9

Powerpack XGT®
BL4040

Prijs excl. BTW

Prijs incl. BTW



**STUNT
PRIJZEN!**

191V6-0

Powerpack XGT®
BL4050F

Prijs excl. BTW

Prijs incl. BTW



**STUNT
PRIJZEN!**



1. CHOOSE YOUR BODY!

2. CHOOSE YOUR POWER!

3. MIX IT UP!



191L29-0

Li-ion accu BL4020
40Vmax • 2,0 Ah • 0,69 kg • 22 min*



191B36-3

Li-ion accu BL4025
40Vmax • 2,5 Ah • 0,71 kg • 28 min*



191B26-6

Li-ion accu BL4040
40Vmax • 4,0 Ah • 1,0 kg • 45 min*



1910N6-8

Li-ion accu BL4040F
40Vmax • 4,0 Ah • 1,0 kg • 45 min*



191L47-8

Li-ion accu BL4050F
40Vmax • 5,0 Ah • 1,3 kg • 50 min*



191X65-8

Li-ion accu BL4080F
40Vmax • 8,0 Ah • 2,0 kg • 80 min*



191J81-6

XGT Powerpack 2,5 Ah



191J65-4

XGT Powerpack 4,0 Ah



191L77-9

XGT Powerpack 4,0 Ah



STUNTPRIJS

1911V6-0

XGT Powerpack 5,0 Ah



STUNTPRIJS

191U00-8

XGT Powerpack 4,0 Ah



191U28-6

XGT Powerpack 4,0 Ah



191U13-9

XGT Powerpack 5,0 Ah



191U42-2

XGT Powerpack 5,0 Ah



191Y97-1

XGT Powerpack 8,0 Ah



DEAADP001G

ADP001 Laadadapter

USB-adapter voor XGT 40Vmax accu's



* Laadtijd met DC40RA

191E07-8

Oplader DC40RA

Snellader voor XGT 40Vmax accu's



191N09-8

Duo snellader DC40RB

Duo snellader voor het gelijktijdig laden van twee XGT 40Vmax accu's



191C10-7

ADP10 Laadadapter

Adapter om LXT 14,4 V en 18 V accu's te laden op een XGT 40Vmax lader



1911L9-4

Duo oplader DC40WA

Traaglader voor XGT 40Vmax accu's



1910D9-2

Communicatieadapter ADP12

Adapter om XGT-machines te verbinden met smartphone, laptop,...

* de adapter wordt enkel tussen machine en accu geplaatst tijdens controle / bij het maken van de gewenste instellingen



- Diefstalbeveiliging instellen d.m.v. een pincode
- De werkingduur van accu's instellen
- De gebruikshistoriek van de XGT-machines raadplegen

BL4040F

DE GEAVANCEERDE "HIGH PERFORMANCE" ACCU

XGT **40V** Li-ion max



KRACHTIG



GROOT UITHOUDINGSVERMOGEN



COMPACT EN LICHT



Krachtiger dan de BL4040 en toch even compact en licht!

De BL4040F heeft een bijzonder lage interne weerstand dankzij het gebruik van Li-ion cellen met een unieke chemische samenstelling en een "tab-less" structuur. Dit levert enkele belangrijke voordelen op:

- **Krachtig**, in de praktijk betekent dit bijvoorbeeld dat het toerental van de machine minder zal terugvallen bij zware belasting. Het piekvermogen van de BL4040F is hoger dan dat van de BL4040 en benadert dat van de grotere BL4050F.
- **Meer uithoudingsvermogen** omdat de accu minder opwarmt: in extreme situaties is de kans op een tijdelijke uitval door oververhitting kleiner.
- **Compact en licht**: de BL4040 en BL4040F hebben dezelfde compacte afmetingen en wegen exact even veel.

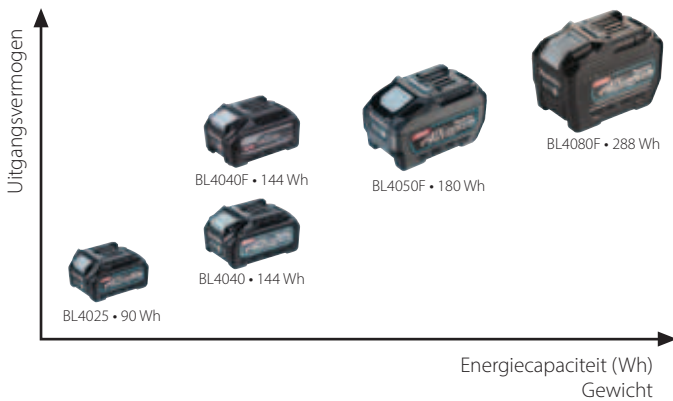

► Zowel de BL4040 als de BL4040F hebben een energiecapaciteit van 144 Wh, maar het uitgangsvermogen van de BL4040F is hoger. De BL4050F heeft wel een nog grotere energiecapaciteit (180 Wh), maar deze accu is dan ook groter en zwaarder omdat deze meer cellen bevat.

Specifieke toepassingen

De BL4040F is een uitstekende keuze wanneer een hoog piekvermogen vereist is en de batterij tegelijkertijd ook zo licht en compact mogelijk moet zijn.

Typische voorbeelden zijn haakse slijpers, boorhamers, cirkelzagen, en (tophandle) kettingzagen.



Wat betekent "tab-less"?

"Tab-less" Li-ion batterijcellen hebben een innovatieve opbouw waarbij het stroompad tussen de anode en de kathode van de cel veel groter is dan bij de klassieke structuur. In plaats van slechts twee verbindingpunten of "tabs" wordt in het nieuwe ontwerp de hele boven- en onderkant van de batterij als elektrode gebruikt. Daardoor is de interne weerstand veel kleiner met als gevolg een kleinere spanningsval, een hogere piekstroom en minder warmteontwikkeling.

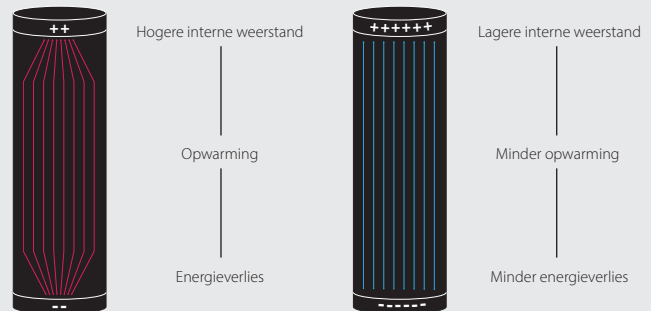

| | BL4040 | BL4040F | BL4050F |
|-------------------|-----------|----------|----------|
| Referentie | 191B26-6 | 1910N6-8 | 191L47-8 |
| Energiecapaciteit | 144 Wh | 144 Wh | 180 Wh |
| Piekvermogen * | 1,5 kW | 2,1 kW | 2,2 kW |
| Gewicht | 1,0 kg | 1,0 kg | 1,4 kg |
| Prijs in €** | excl. btw | | |
| | incl. btw | | |

* Het maximum vermogen dat gedurende 3 min geleverd kan worden.



Stroomomvormer BAC01 voor PDC (accupack)

Laad je accu's en gebruik je favoriete 230 V machines overal, zonder netstroom!

- Dient gevoed te worden met PDC1500, PDC1200 of PDC01.
- Converteert de 36 V gelijkspanning van de PDC naar een 230 V wisselspanning.
- Twee 230 V uitgangen met instelling van de frequentie 50/60 Hz.
- Maximale continue belasting van 1400 W (VA) en piekbelasting tot 2800 W (VA).
- De hoogwaardige elektronica produceert een wisselspanning met zuivere sinusgolf.
- Beveiligd tegen overbelasting en oververhitting.
- Ideaal om gesnoerde machines te kunnen gebruiken op plaatsen waar geen elektriciteitsaansluiting voorhanden is, voor outdoor toepassingen en als noodvoeding.



Combinatie met PDC01 (art.nr. BAC01PDC01BE)



Combinatie met PDC1200 (art. nr. BAC01PDC1200BE)



Groot display met duidelijke weergave van de actuele belasting.



Zuivere sinusgolf uitgangsspanning, veilig voor gevoelige apparatuur.



Meerdere USB uitgangen b.v. voor het laden van mobiele apparaten.



Beschikt over een 12V DC uitgang type sigarettenaanstecker.

TECHNISCHE SPECIFICATIES

| | BAC01 |
|--|--|
| AC uitgangsspanning | 230 V 50/60 Hz |
| Voedingspanning | 36 V DC |
| Max. continu belasting met PDC1500/PDC1200 | 1400 W (VA) |
| Max. continu belasting met PDC01 | 750 W (VA) |
| Piekbelasting (4 s) | 2800 W (VA) |
| DC uitgangen | 2x USB Type A 2x USB Type C 1 x 12V DC |
| Autonomie met PDC01, 4x BL1850 en belasting van 750 W (VA) | ± 16 min |
| Autonomie met PDC1200 en belasting van 1000 W (VA) | ± 56 min |
| Gewicht | 7,3 - 16,2 kg |



Uitklapbare handvaten voor gemakkelijk transport.



Te monteren op een Makpac en compatibel met de trolley.

| | | EUABAC01 | BAC01PDC01BE | BAC01PDC1200BE |
|------------|-----------|----------|--------------|----------------|
| Uitvoering | | BAC01 | BAC01+PDC01* | BAC01+PDC1200 |
| Prijs € | excl. btw | | | |
| | incl. btw | | | |

* batterijen niet meegeleverd

BCC01

LAADSTATION

XGT
40V Li-ion max

NIEUW

Met het laadstation BCC01 kunnen tot 8 accu's volledig automatisch geladen worden.

- Vier accu's worden gelijktijdig geladen waarna automatisch overgeschakeld wordt naar de volgende rij.
- 40Vmax accu's passen rechtstreeks en ook 14,4/18V accu's kunnen geladen worden via de optionele ADP10 adapter.
- De lader (DC4002) wordt via een connector aan het station aangesloten.
- Het laadstation heeft de afmetingen van een Makpac IV en kan horizontaal of verticaal op een schap geplaatst worden.
- Het laadstation kan gestapeld worden zoals andere Makpacs en past ook op een trolley.
- Het deksel is semi-transparant, waardoor de inhoud en de laadstatus van de accu's ook zichtbaar is zonder het deksel te openen.
- Beschermingsklasse IPX4-compatibel



De accu's worden rij per rij geladen.



De handvaten kunnen opgeplooid worden tot een hoek van 135°.



Het laadstation past op andere Makpacs en ook op de trolley.



Voor elke batterij wordt de laadstatus met een driekleurige LED aangegeven



Het laadstation kan horizontaal of verticaal op een schap geplaatst worden.



Ter beveiliging tegen diefstal kan een hangslot bevestigd worden.



Het deksel kan ook volledig verwijderd worden.



Met de ADP10 adapter kunnen ook LXT accu's geladen worden

| | | |
|------------------------------------|---------------------------|--|
| Referentie | 1914U3-7 | |
| Max. uitgangsvermogen | 230,4 W | |
| Laadstroom per accu | 1,6 A (XGT) / 2,1 A (LXT) | |
| Laadtijd BL4025 voor 4/8 accu's | 90 min / 180 min | |
| Laadtijd BL4040(F) voor 4/8 accu's | 145 min / 290 min | |
| Laadtijd BL4050F voor 4/8 accu's | 175 min / 350 min | |
| Laadtijd BL4080F voor 4/8 accu's | 280 min / 560 min | |
| Prijs in €** | excl. btw | |
| | incl. btw | |

XGT

40V Li-ion max

Hoog vermogen

Robuust

Digitale
communicatie



XGT

40V Li-ion max

XGT X2
80V max



Accu

BL4020
2.0Ah

BL4025 /
BL4025F
2.5Ah

BL4040 /
BL4040F
4.0Ah



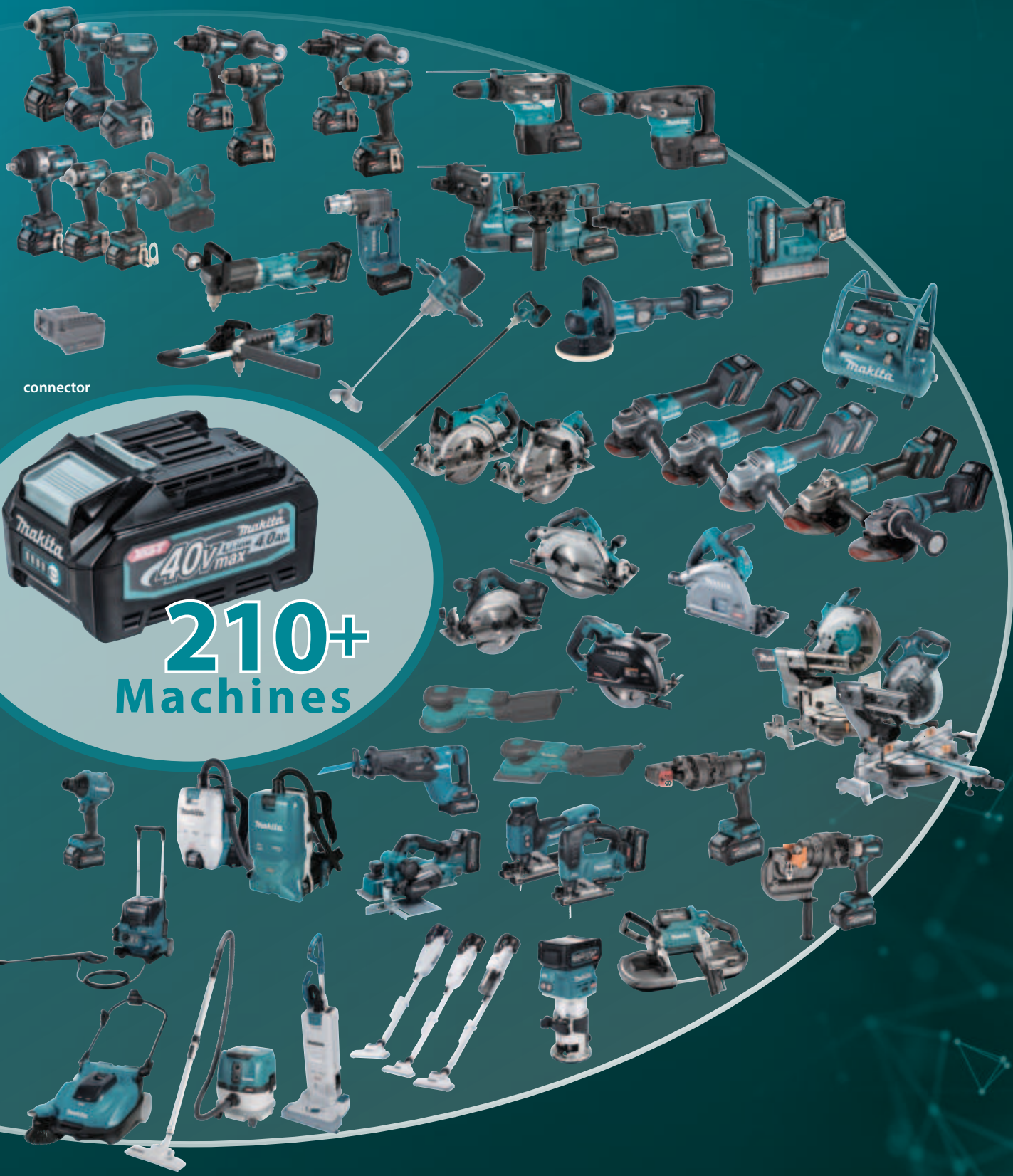

connector



210+
Machines

Lader

BL4050F
5.0Ah

BL4080F
8.0Ah

DC40RA

DC40RB

DC40WA

DC40RC

ADP10



Adapter voor
LXT Batterij

LXT-Platform

Betrouwbaar – veelzijdig – krachtig

Snel en optimaal laden

Wanneer de batterijen warm zijn, dan is het belangrijk dat die eerst gekoeld worden vooraleer het laadtraject te starten. De lader is uitgerust met een ventilator die de batterijen koelt vóór en tijdens het laden om de laadtijd te verkorten.

Makita geavanceerd laadsysteem
Geforceerde koeling



Snelladen



Standaard laadsysteem
Natuurlijke warmteafvoer



Langere laadtijd



3.0Ah
Li-ion

22 minuten

3,0 Ah
BL1830B

SNELSTE LAADTIJD

4.0Ah
Li-ion

36 minuten

4,0 Ah
BL1840B

5.0Ah
Li-ion

45 minuten

5,0 Ah
BL1850B

6.0Ah
Li-ion

55 minuten

6,0 Ah
BL1860B

LANGSTE WERKDUUR





18V
LITHIUM-ION

18V + 18V →

36V

LXT

Met de uitgebreide LXT-serie biedt Makita een accu voor meer dan 420 machines en tuingereedschap dat werkt op 18 V en 2 x 18 V. Het voortdurend groeiende LXT-platform biedt professionele oplossingen voor elke klus

197280-8

accu BL1850B 18V 5,0 Ah



197288-2

TWINPACK 18V 2 x 5,0 Ah



197422-4

accu BL1860B 18V 6,0 Ah



DECADP05

USB-adapter

USB-adapter voor 14,4V/18V accu's



197494-9

POWERPACK 18V 2 x 4,0 Ah



197624-2

POWERPACK 18V 2 x 5,0 ah



197629-2

POWERPACK 18V 2 x 5,0 Ah



197626-8

POWERPACK 18V 4 x 5,0 Ah



198116-4

Powerpack 18V 2 x 6,0 Ah



198077-8

POWERPACK 18V 2 x 6,0 Ah



198091-4

POWERPACK 18V 4 x 6,0 Ah



198170-8

Accu timer LXT BPS01
Programmeert de werkingsduur
van 14,4V & 18V accu's



1914J1-4
OPLADER DC18RC

Snellader voor LXT accu's van 14,4/18V



196933-6
DUBBELLADER DC18RD

Duo snellader voor LXT accu's: 14,4/18V



2 accu's BL1850 laden
in 45 minuten

196426-3
Oplader DC18SF

Traaglader voor LXT accu's, 4 poorten
Laadt twee accu's tegelijk op



Het grootste 18 V Lithium-ion assortiment ter wereld.

Meer dan 440 machines met slechts één accu.

18V
LITHIUM-ION

3
JAAR
GARANTIE
OP MACHINES
Na registratie op
www.makita.be

LXT

Lithium-Ion Extreme Technology

- + Performante Lithium-Ion accu's
- + Een unieke en snelle oplaadtechnologie
- + Energie-efficiënte koolborstelloze motoren
- + Meervoudige bescherming tegen overbelasting





Kettingzaag

Hoogsnoeier

Grastrimmer

Grasmaaiers

Snoeischaar

Bladblazers

Draagbaar accupack

Haagschaar

Hogedrukreiniger

Slagmoersleutels

Stofzuigers

Waterkoker

Combisysteem

Vacuumpomp

Boormachine

Ruggedragen stofzuigers

Staan-
de stofzuiger

Menger

Slagschroevendraaiers

Schroefmachines

2x 18V

Schroefautomaten

Haakse slag-
schroevendraaiers

Slagschroevendraaiers

Schroefmachines

Haakse boormachines

Klopboormachines

Ratelmoersleutel

Boor- en
schroefmachines

Bijl. 1

Boorhamers

18V

Betonijzerzaag

Plaatschaar

Combihamers
SDS-plus

Metaalcirkelzagen

Boven- en
kantenfrees

Multitool

Knabbel-
schaar

Combihamers
SDS-plus

Reciprozagen

Schuur-
polijst-
machine

Draadstangknippers

Zaagmachines

Gipszaag

Cirkelzagen

Langnek-
schuur-
machine

Handpalm-
schuur-
machines

Polijst-
machines

Bandzagen

Bandschuur-
machine

Decoupeerzagen

Afkort-
verstekzagen

Haakse slijper

18V
LITHIUM-ION

ACCU (KLOP-)BOOR- EN SCHROEFMACHINE



DHP453RFX2

incl. 96 accessoires



| | | DHP453RFX2 |
|---------------------|-----------|-------------|
| Spanning | | 18 V |
| Bijgeleverde accu's | | 2 x BL1830B |
| Hard koppel | | 42 Nm |
| Boorkop | | 1,5-13 mm |
| Gewicht | | 1,7 kg |
| Prijs in € | excl. btw | |
| | incl. btw | |

ACCU (KLOP-)BOOR- EN SCHROEFMACHINES



DDF453RF3J



DDF484RT3J



DDF486RT3J

Uitgeleverd met 3 accu's!

| | | DDF453RF3J | DDF482RT3J | DDF484RT3J | DDF486RT3J | DHP486RT3J |
|---------------------|-----------|-------------|-------------|-------------|--------------|--------------|
| Spanning | | 18 V | 18 V | 18 V | 18 V | 18 V |
| Bijgeleverde accu's | | 3 x BL1830B | 3 x BL1850B | 3 x BL1850B | 3 x BL1850B | 3 x BL1850B |
| BL-motor | | - | - | ✓ | ✓ | ✓ |
| Klopboorfunctie | | - | - | - | - | ✓ |
| Hard koppel | | 42 Nm | 62 Nm | 54 Nm | 130 Nm | 130 Nm |
| Boorkop | | 1,5-13 mm | 1,5-13 mm | 1,5-13 mm | 1,5 - 13 mm | 1,5 - 13 mm |
| Gewicht | | 1,7 kg | 1,7 kg | 1,5 kg | 2,3 - 2,6 kg | 2,3 - 2,7 kg |
| Prijs in € | excl. btw | | | | | |
| | incl. btw | | | | | |

ACCU (KLOP-)BOOR- EN SCHROEFMACHINES



DDF489/DHP489

- Uiterst krachtige en compacte machine voor all-round gebruik
- Volledig metalen boorkop



DDF083ZJ



DDF487RAJ



DHP486RT3J



DDF489RTJ



DDF484RTJ



PROMOPRIJS

Wist je dat er van DDF484 en DHP486 ook de voordelige uitvoeringen DDF484Z / DDF484TJ en DHP486Z / DHP486TJ bestaan? Zie p. 76-77 voor meer info!

| | DDF083ZJ | DDF487RAJ | DDF489RTJ |
|---------------------|--------------|--------------|-------------|
| Spanning | 18 V | 18 V | 18 V |
| Bijgeleverde accu's | - | 2 x BL1820 | 2 x BL1850B |
| Klopboorfunctie | - | - | - |
| Hard koppel | 40 Nm | 40 Nm | 50 Nm |
| Opname | 1/4 hex | 1,5 - 13 mm | 1,5-13 mm |
| Gewicht | 1,1 - 1,4 kg | 1,3 - 1,6 kg | 1,4 kg |
| Prijs in € | excl. btw | | |
| | incl. btw | | |

| | PROMOPRIJS DDF484RTJ | PROMOPRIJS DDF489RTJ | PROMOPRIJS DDF486RTJ | PROMOPRIJS DHP487RAJ | PROMOPRIJS DHP485RFJ | PROMOPRIJS DHP484RTJ | PROMOPRIJS DHP489RTJ | PROMOPRIJS DHP486RT3J |
|---------------------|-------------------------|-------------------------|-------------------------|-------------------------|-------------------------|-------------------------|-------------------------|--------------------------|
| Spanning | 18 V | 18 V | 18 V | 18 V | 18 V | 18 V | 18 V | 18 V |
| Bijgeleverde accu's | 2 x BL1850B | 2 x BL1850B | 2 x BL1850B | 2 x BL1820 | 2 x BL1830B | 2 x BL1850B | 2 x BL1850B | 3 x BL1850B |
| Klopboorfunctie | - | - | - | ✓ | ✓ | ✓ | ✓ | ✓ |
| Hard koppel | 54 Nm | 73 Nm | 130 Nm | 40 Nm | 50 Nm | 54 Nm | 73 Nm | 130 Nm |
| Opname | 1,5-13 mm | 1,5-13 mm | 1,5-13 mm | 1,5 - 13 mm | 1,5-13 mm | 1,5-13 mm | 1,5 - 13 mm | 1,5 - 13 mm |
| Gewicht | 1,6 - 2,2 kg | 1,8 - 2,5 kg | 2,3 - 2,7 kg | 1,3 - 1,6 kg | 1,4 - 1,7 kg | 1,6 - 2,2 kg | 1,8 - 2,5 kg | 2,3 - 2,7 kg |
| Prijs in € | excl. btw | | | | | | | |
| | incl. btw | | | | | | | |

ACCU HAAKSE BOORMACHINES



DDA450RTE



DDA460ZK



DDA351RTJ

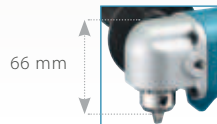

DDA350RTJ

| | DDA350ZJ | DDA351RTJ | DDA450RTE | DDA460ZK |
|---------------------|---------------|---------------|-----------------------------------|-------------------------------|
| Spanning | 18 V | 18 V | 18 V | 2 x 18 V |
| Bijgeleverde accu's | - | 2 x BL1850B | 2 x BL1850B | - |
| Toerental | 0-1800 t.p.m. | 0-1800 t.p.m. | 0 - 450 t.p.m. 0 - 1400 t.p.m. | 0-350 t.p.m. 0-1400 t.p.m. |
| BL motor | - | - | ✓ | ✓ |
| XPT | - | - | ✓ | ✓ |
| Hard koppel | 13,7 Nm | 13,7 Nm | 26/70 Nm | 70/136 Nm |
| Boorkop | 1,5-10 mm | 1,5-10 mm | 1,5-13 mm | 1,5-13 mm |
| Gewicht | 1,8 kg | 1,8 kg | 3,2 kg | 5,7 kg |
| Prijs in € | excl. btw | | | |
| | incl. btw | | | |

ACCU BIKHAMER SDS-PLUS



DHK180RTJ

| | DHK180ZJ | DHK180RTJ |
|-------------------------------|----------------------|----------------------|
| Spanning | 18V | 18V |
| Bijgeleverde accu's | 0 | 2 x BL1850B |
| Slagenergie | 3,1J | 3,1 J |
| Slagfrequentie | 0 - 3200/min | 0 - 3200/min |
| Triaxiale vibratiewaarde (ah) | 4,5 m/s ² | 4,5 m/s ² |
| Gewicht | 3,3 kg | 3,3 kg |
| Prijs in € | excl. btw | |
| | incl. btw | |

ACCU BOORHAMERS SDS-PLUS



PROMO

DHR243RTJ
Gratis 3e accu
5 Ah BL1850B



DHR171RTJ



DHR202RTJ



DHR183RTWJ



DHR243RTJ



DHR182RTWJ



DHR182RTWJ, DHR243RTJWJ,
DHR183RTWJ
incl. STOFAFZUIGING

NIEUW
OPTIONEEL ACCESSOIRE
stofafzuiging boorhamers
1914X3-8



- combinatie van flexibel gebruik en sterke zuigkracht (120 N)
- gemakkelijke aanpassing van zuigkracht en positie
- max. boordiameter 52 mm
- koppelbaar met slangdiameter 24 en 38

Wist je dat er van DHR243 ook de voordelige uitvoeringen DHR243Z en DHR243T1J bestaan? Zie p. 76-77 voor meer info!

| | DHR171RTJ | DHR183RTWJ | DHR202RTJ | DHR182RTJ | DHR182RTWJ | DHR243RTJ | DHR243RTJWJ |
|-----------------------|-------------|--------------|-------------|-------------|-------------|-------------|-------------|
| Spanning | 18V | 18V | 18V | 18V | 18V | 18V | 18V |
| Bijgeleverde accu's | 2 x BL1850B | 2 x BL1850B | 2 x BL1850B | 2 x BL1850B | 2 x BL1850B | 2 x BL1850B | 2 x BL1850B |
| Slagenergie | 1,2 J | 1,7 J | 2 J | 1,7 J | 1,7 J | 2 J | 2 J |
| Max. Ø beton | 16 mm | 16 mm | 20 mm | 18 mm | 18 mm | 24 mm | 24 mm |
| BL-motor | ✓ | ✓ | - | ✓ | ✓ | ✓ | ✓ |
| AVT | - | ✓ | - | ✓ | ✓ | - | - |
| AWS | - | - | - | ✓ | ✓ | - | - |
| Stofafzuigstelsysteem | - | DX16 | - | - | DX05 | - | DX07 |
| Gewicht | 2,1 kg | 2,1 - 2,8 kg | 3,5 kg | 2,4 kg | 3,3 kg | 3,2 kg | 4,7 kg |
| Prijs in € | excl. btw | | | | | | |
| | incl. btw | | | | | | |

Technologie

AFT

Active feedback sensing technology

Deze technologie schakelt de motor onmiddellijk uit bij het plots blokkeren van de machine. Sommige machines maken daarbij gebruik van een accelerometer die de zwenkbeweging van de machine detecteert. De AFT-technologie verhoogt de veiligheid enorm.

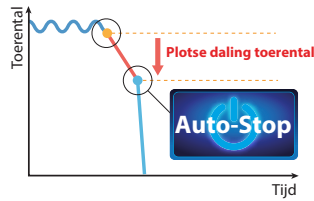

AVT

Anti-vibration technology

Het AVT-systeem reduceert trillingen drastisch door het gebruik van een systeem met bewegend tegengewicht, hetgeen het gebruikskomfort sterk verbetert.

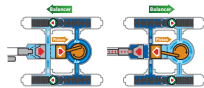

Auto-start wireless system

Dankzij AWS wordt de stofafzuiging bij accu-toestellen automatisch geactiveerd d.m.v. een Bluetooth®-verbinding.



ACCU COMBIHAMERS SDS-PLUS



DHR283G2JU



DHR264PT2J



DHR283ZWJU
inclusief
STOFAFZUIGING



Alle modellen
INCLUSIEF extra
automatische
boorkop



| | DHR264PT2J | DHR283ZJU | DHR283ZWJU | DHR283G2JU |
|-----------------------|-------------|-----------|------------|-------------|
| Spanning | 2 x 18V | 2 x 18V | 2x18V | 2 x 18V |
| Bijgeleverde accu's | 2 x BL1850B | 0 | 0 | 2 x BL1860B |
| BL-motor | - | ✓ | ✓ | ✓ |
| Slagenergie | 2,5 J | 2,8 J | 2,8 J | 2,8 J |
| Max. Ø beton | 26 mm | 28 mm | 28 mm | 28 mm |
| AWS | - | ✓ | ✓ | ✓ |
| AVT | - | ✓ | ✓ | ✓ |
| AFT | - | ✓ | ✓ | ✓ |
| Stofafzuigstelsysteem | - | - | DX09 | - |
| Gewicht | 4,2 kg | 4,0 kg | 5,5 kg | 4,0 kg |
| Prijs in € | excl. btw | | | |
| | incl. btw | | | |

IMPACT BLACK KRACHTDOPPENSETS



E-16564



E-16586



E-16601



E-16639



E-16645

| Artikel | Opname | Diameters (mm) | Lengte (mm) | Prijs excl. btw | Prijs incl. btw |
|---------|--------|--|-------------|-----------------|-----------------|
| E-16601 | 1/2" | 8, 10, 12, 13, 14, 17, 19, 21 | 38 | | |
| E-16564 | 1/2" | 8, 10, 13, 16, 17, 18, 19, 21, 24 | 38 | | |
| E-16586 | 1/2" | 10, 11, 12, 13, 14, 16, 17, 19, 21, 22, 24, 27, 30, 32 | 81,5 | | |
| E-16645 | 1/2" | 8, 10, 12, 13, 14, 15, 17, 18 | 38 | | |
| E-16639 | 3/8" | 8, 10, 12, 13, 14, 15, 17, 18 | 38 | | |

Schroefbitdoppen - Om schroeven te bevestigen met een hoog koppel met behulp van een slagmoersleutel!

| Artikel | Opname | Bitmaat | Lengte (mm) | Prijs excl. btw | Prijs incl. btw |
|---------|--------|---------|-------------|-----------------|-----------------|
| E-19794 | 1/2" | T30 | 78 | | |
| E-19803 | 1/2" | T35 | 78 | | |
| E-19819 | 1/2" | T40 | 78 | | |
| E-19825 | 1/2" | T45 | 78 | | |
| E-19831 | 1/2" | T50 | 78 | | |
| E-19847 | 1/2" | T55 | 78 | | |
| E-19853 | 1/2" | T60 | 78 | | |



E-19819

ACCU COMBIHAMER SDS-MAX



DHR400ZKUN

DHR400ZKUN DHR400G2UN

| | | |
|---------------------------|----------------------|----------------------|
| Spanning | 2 x 18 V | 2 x 18 V |
| Bijgeleverde accu's | - | 2 x BL1860B |
| Slagenergie | 8 J | 8 J |
| Max. Ø beton | 40 mm | 40 mm |
| Vibratieniveau hamerboren | 5,0 m/s ² | 5,0 m/s ² |
| AWS | ✓ | ✓ |
| AFT | ✓ | ✓ |
| Gewicht | 8,1 kg | 8,1 kg |
| Prijs in € | excl. btw | |
| | incl. btw | |

ACCU HETELUCHTPISTOLEN



DHG180RT1J



DHG181RT1J

DHG180RT1J DHG181RT1J

| | | |
|---------------------|--------------|-----------------------|
| Spanning | 18V | 18V |
| Bijgeleverde accu's | 1x BL1850B | 1x BL1850B |
| Temperatuurbereik | 550 °C | 6 standen, max 550 °C |
| Debiet | 200 l/min | 120 l/min, 200 l/min |
| Gewicht | 1,0 - 1,3 kg | 1,0 - 1,4 kg |
| Prijs in € | excl. btw | |
| | incl. btw | |

- Snelle wissel van het mondstuk
- Veilige schakelaar, te blokkeren in uit en aan stand
- Verschillende mondstukken zijn inbegrepen

ACCU SLAGMOERSLEUTELS



DTW1001RTJ

Auto-stop:
de machine stopt automatisch van zodra de bout of moer voldoende is losgedraaid

Wist je dat er van DTW300 de voordelige uitvoeringen DTW300Z en DTW300T1J bestaan? Zie p. 76-77 voor meer uitleg!



DTW190RTJ



DTW300RTJ



DTW700RTJ



DTW181RTJ

PROMO

DTW700RTJ
GRATIS 120-delige gereedschapset E-06616



| | DTW181RTJ | DTW190RTJ | DTW300RTJ | DTW700RTJ | DTW1001RTJ | DTW1002RTJ |
|---------------------|---------------|---------------|---------------|---------------|---------------|---------------|
| Spanning | 18V | 18V | 18V | 18V | 18V | 18V |
| Bijgeleverde accu's | 2 x BL1850B | 2 x BL1850B | 2 x BL1850B | 2 x BL1850B | 2 x BL1850B | 2 x BL1850B |
| BL-motor | ✓ | - | ✓ | ✓ | ✓ | ✓ |
| XPT | ✓ | - | ✓ | ✓ | - | - |
| Toerental | 0-2400 tpm. | 0-2400 tpm. | 0-3200 tpm. | 0-2200 tpm. | 0-1800 t.p.m. | 0-1800 t.p.m. |
| Max. koppel | 180 Nm | 190 Nm | 330 Nm | 700 Nm | 1250 Nm | 1200 Nm |
| Dopaansluiting | 1/2" vierkant | 1/2" vierkant | 1/2" vierkant | 1/2" vierkant | 3/4" vierkant | 1/2" vierkant |
| Auto-stop functie | ✓ | - | ✓ | ✓ | - | - |
| Gewicht | 1,2 kg | 1,4 kg | 1,8 kg | 2,6 kg | 3,4 kg | 3,3 kg |
| Prijs in € | excl. btw | | | | | |
| | incl. btw | | | | | |

ACCU RATELMOERSLEUTEL



Geleverd met 1/4" & 3/8" opname

Verwijderbare kop laat toe om 13 mm moeren over de lengte van een M8 draadstang te schroeven.



DWR180A1J



| | DWR180ZJ | DWR180A1J |
|---------------------|--------------|--------------|
| Spanning | 18V | 18V |
| Bijgeleverde accu's | 0 | 1 x BL1820B |
| Toerental onbelast | 0-800 t.p.m. | 0-800 t.p.m. |
| Max. koppel | 47,5 Nm | 47,5 Nm |
| Gewicht | 1,2 kg | 1,2 kg |
| Prijs in € | excl. btw | |
| | incl. btw | |

ACCU BREEKMOERSLEUTEL



- Voor het vastdraaien van torsiebreekbouten met een hoge trekvastheid (type HTB/SHTB).
- Torsiebreekbouten worden vooral gebruikt bij industriële staalconstructies.

| | DWT310ZK |
|----------------------|----------------------|
| Spanning | 2x18V |
| Bijgeleverde accu's | - |
| Toerental onbelast | 14 min ⁻¹ |
| Max. koppel | 804 Nm |
| Compatibiliteit HTB | M16, M20, M22 |
| Compatibiliteit SHTB | M16, M20 |
| Gewicht | 6,5 - 7,1 kg |
| Prijs in € | excl. btw |
| | incl. btw |



Impact PREMIER

ACCESSOIRES

IMPACT PREMIER

Duurzamer door de dubbele torsie!



E-13568
5-delige schroefbitset



Past zeer nauwkeurig in de schroef.

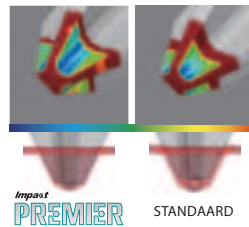

E-03567
11-delige schroefbitset



Gebruik van hoogwaardig staal. Ondersteunt een hoog koppel.

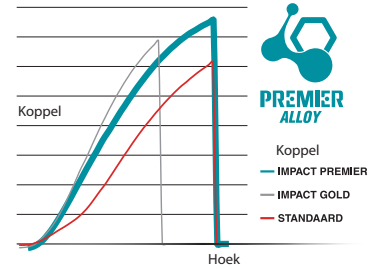

E-13552
31-delige schroefbitset



Excl. BTW / Incl. BTW

Excl. BTW / Incl. BTW

- E-03121 Schroefbit IMPACT PREMIER PH1-25 mm, 2 stks
- E-03137 Schroefbit IMPACT PREMIER PH2-25 mm, 2 stks
- E-03143 Schroefbit IMPACT PREMIER PH2(slim)-25 mm, 2 stks
- E-03159 Schroefbit IMPACT PREMIER PH3-25 mm, 2 stks
- E-03165 Schroefbit IMPACT PREMIER PZ1-25 mm, 2 stks
- E-03171 Schroefbit IMPACT PREMIER PZ2-25 mm, 2 stks
- E-03187 Schroefbit IMPACT PREMIER PZ3-25 mm, 2 stks
- E-03193 Schroefbit IMPACT PREMIER T10-25 mm, 2 stks
- E-03202 Schroefbit IMPACT PREMIER T15-25 mm, 2 stks
- E-03218 Schroefbit IMPACT PREMIER T20-25 mm, 2 stks
- E-03224 Schroefbit IMPACT PREMIER T25-25 mm, 2 stks
- E-03230 Schroefbit IMPACT PREMIER T30-25 mm, 2 stks
- E-20242 Schroefbit IMPACT PREMIER T40-25 mm, 2 stks
- E-03246 Schroefbit IMPACT PREMIER PH2-25 mm, 15 stks Flip top
- E-03252 Schroefbit IMPACT PREMIER PZ2-25 mm, 15 stks Flip top

- E-03268 Schroefbit IMPACT PREMIER PH1-50 mm, 2 stks
- E-03274 Schroefbit IMPACT PREMIER PH2-50 mm, 2 stks
- E-03280 Schroefbit IMPACT PREMIER PH3-50 mm, 2 stks
- E-03296 Schroefbit IMPACT PREMIER PZ1-50 mm, 2 stks
- E-03305 Schroefbit IMPACT PREMIER PZ2-50 mm, 2 stks
- E-03311 Schroefbit IMPACT PREMIER PZ3-50 mm, 2 stks
- E-03327 Schroefbit IMPACT PREMIER T10-50 mm, 2 stks
- E-03333 Schroefbit IMPACT PREMIER T15-50 mm, 2 stks
- E-03349 Schroefbit IMPACT PREMIER T20-50 mm, 2 stks
- E-03355 Schroefbit IMPACT PREMIER T25-50 mm, 2 stks
- E-03361 Schroefbit IMPACT PREMIER T30-50 mm, 2 stks
- E-12027 Schroefbit IMPACT PREMIER T40-50 mm, 2 stks
- E-03377 Schroefbit IMPACT PREMIER PH2-50 mm, 10 stks Flip top
- E-03383 Schroefbit IMPACT PREMIER PZ2-50 mm, 10 stks Flip top



- E-06286 Dubbelbit IMPACT PREMIER PH2-65 mm, 2 stks
- E-06292 Dubbelbit IMPACT PREMIER PZ2-65 mm, 2 stks



- E-20258 IMPACT PREMIER Torsion bithouder 68 mm (magnetisch)
- E-20264 IMPACT PREMIER Torsion bithouder 150 mm (magnetisch)



- E-20270 ULTRA MAG bithouder IMPACT PREMIER TORSION (magnetisch)



- E-03420 IMPACT PREMIER Tilt adapter 1/4" voor krachtdoppen 3/8" - 50 mm
- E-03436 IMPACT PREMIER Tilt adapter 1/4" voor krachtdoppen 1/2" - 50 mm



- E-03442 IMPACT PREMIER Mag Boost magneet voor schroefbits



- E-03458 IMPACT PREMIER Torsion dopsleutel H6-65 mm
- E-03464 IMPACT PREMIER Torsion dopsleutel H8-65 mm
- E-03470 IMPACT PREMIER Torsion dopsleutel H10-65 mm
- E-03486 IMPACT PREMIER Torsion dopsleutel H13-65 mm



- E-03492 IMPACT PREMIER krachtdop H13-80 mm
- E-03501 IMPACT PREMIER krachtdop H15-80 mm
- E-03517 IMPACT PREMIER krachtdop H17-80 mm
- E-03523 IMPACT PREMIER krachtdop H19-80 mm
- E-03539 IMPACT PREMIER krachtdop H21-80 mm



- E-22888 IMPACT PREMIER dopsleutel 8x50 mm (niet-magnetisch)
- E-22894 IMPACT PREMIER dopsleutel 10x50 mm (niet-magnetisch)



- E-03573 11-delige IMPACT PREMIER schroefbitset



ACCU SLAGSCHROEVENDRAAIERS



DTD153RTJ



DTD157ZJ



DTD172RTJ



DTD173RTJ

DTD173

- Vier slagkrachtingsinstellingen en 4 application modes
- Het controlepaneel is aan de achterkant geplaatst naar de gebruiker gericht, dat maakt het instellen gemakkelijker.
- Verbeterde balans, nog compacter en zeer smalle kop.
- Goede verlichting zonder schaduwen dankzij een ringvormige led.

"Application modes"

"Application" of "assist" modes ondersteunen de gebruiker bij specifieke toepassingen door het toerental automatisch te variëren of de machine automatisch te laten stoppen.

- Mode voor (hout)schroeven: de machine start met een laag toerental voor het vlot aanzetten.
- Mode voor zelftappende schroeven: de machine start met hoog toerental en stopt automatisch als de schroef vast zit.
- Mode voor bouten: de machine stopt automatisch wanneer de bout losgedraaid is.

Check ook de voordelige uitvoeringen DTD153ZJ, DTD154ZJ en DTD173ZJ op pagina 76-77!

| | DTD156Z | DTD153RTJ | DTD157ZJ | DTD154RTJ | DTD172RTJ | DTD173RTJ |
|----------------------------------|---------------|---------------|---------------|---------------|---------------|---------------|
| Spanning | 18V | 18V | 18V | 18V | 18V | 18V |
| Bijgeleverde accu's | - | 2 x BL1850B | - | 2 x BL1850B | 2 x BL1850B | 2 x BL1850B |
| BL-motor | - | ✓ | ✓ | ✓ | ✓ | ✓ |
| Toerental | 0-2500 t.p.m. | 0-3400 t.p.m. | 0-3000 t.p.m. | 0-3600 t.p.m. | 0-3600 t.p.m. | 0-3600 t.p.m. |
| Max. koppel | 155 Nm | 170 Nm | 140 Nm | 175 Nm | 180 Nm | 180 Nm |
| Bitopname | 1/4" hex. | 1/4" hex. | 1/4" hex. | 1/4" hex. | 1/4" hex. | 1/4" hex. |
| Slagkrachtniveaus | - | - | 2 | 3 | 4 | 4 |
| Mode voor zelftappende schroeven | - | - | - | ✓ | ✓(2 modes) | ✓(2 modes) |
| Mode voor houtschroeven | - | - | ✓ | - | ✓ | ✓ |
| Mode voor bouten | - | - | - | - | ✓ | ✓ |
| Gewicht | 1,3-1,6 kg | 1,3-1,6 kg | 1,2-1,5kg | 1,3-1,6 kg | 1,2-1,5 kg | 1,2-1,5 kg |
| Prijs in € | excl. btw | | | | | |
| | incl. btw | | | | | |

ACCU HAAKSE SLAGSCHROEVENDRAAIER



DTL061RTJ

| | |
|---------------------|---------------|
| Spanning | 18V |
| Bijgeleverde accu's | 2 x BL1850B |
| Toerental | 0-2000 t.p.m. |
| Gewicht | 1,8 kg |
| Prijs in € | excl. btw |
| | incl. btw |

ACCU HYBRIDE BOOR- EN SCHROEFMACHINE



DTP141RTJ

4 modi:
klopbooren, boren, schroeven, slag Schroeven

| | DTP141ZJ | DTP141RTJ |
|---------------------|---------------|---------------|
| Spanning | 18V | 18V |
| Bijgeleverde accu's | - | 2 x BL1850B |
| Toerental | 0-2700 t.p.m. | 0-2700 t.p.m. |
| Gewicht | 1,8 kg | 1,8 kg |
| Prijs in € | excl. btw | |
| | incl. btw | |

ACCU HYDRAULISCHE SLAGSCHROEVENDRAAIER



DTS141ZJ

Uiterst stil
dankzij het unieke hydraulische impulsysteem

| | DTS141ZJ |
|---------------------|---------------|
| Spanning | 18V |
| Bijgeleverde accu's | - |
| Toerental | 0-3200 t.p.m. |
| Max. koppel | 40 Nm |
| Bitopname | 1/4" hex |
| T-modus | ✓ |
| Gewicht | 1,5 kg |
| Prijs in € | excl. btw |
| | incl. btw |

ACCU AFWERKINGSPISTOOL
23 Ga



DPT353RTJ

| | |
|---------------------|-------------|
| Spanning | 18V |
| Bijgeleverde accu's | 2 x BL1850B |
| Doorsnede nagel | 0,6 mm |
| Lengte nagel | 15-35 mm |
| Gewicht | 2,0 kg |
| Prijs in € | excl. btw |
| | incl. btw |

ACCU NIETMACHINES



DST221RTJ

DST221:
Aluminium magazijn

DST112RTJ DST221RTJ

| | | |
|---------------------|-------------|-------------|
| Spanning | 18V | 18V |
| Bijgeleverde accu's | 2 x BL1850B | 2 x BL1850B |
| Rugbreedte niet | 10 mm | 10,5 mm |
| Lengte niet | 7-10 mm | 10-22 mm |
| Gewicht | 1,5 kg | 2,1 kg |
| Prijs in € | excl. btw | |
| | incl. btw | |

ACCESSOIRES



F-32647

| Art.nr. | Lengte | Breedte | Dikte | Gegalvaniseerd | Draadkaliber | Stuks/verpakking | Prijs excl. btw | Prijs incl. btw |
|---------|--------|----------|--------|----------------|--------------|------------------|-----------------|-----------------|
| F-32647 | 10 mm | 10,55 mm | 0,6 mm | ✓ | | 5040 | | |
| F-32650 | 13 mm | 10,55 mm | 0,6 mm | ✓ | | 5040 | | |
| F-32663 | 16 mm | 10,55 mm | 0,6 mm | ✓ | | 5040 | | |
| F-32676 | 19 mm | 10,55 mm | 0,6 mm | ✓ | | 5040 | | |
| F-32689 | 22 mm | 10,55 mm | 0,6 mm | ✓ | | 5040 | | |



F-31841

| Art.nr. | Lengte | Breedte | Dikte | Gegalvaniseerd | Draadkaliber | Stuks/verpakking | Prijs excl. btw | Prijs incl. btw |
|---------|--------|---------|--------|----------------|--------------|------------------|-----------------|-----------------|
| F-31825 | 18 mm | 0,6 mm | 0,6 mm | ✓ | 23 Ga | 10000 | | |
| F-31838 | 25 mm | 0,6 mm | 0,6 mm | ✓ | 23 Ga | 10000 | | |
| F-31841 | 30 mm | 0,6 mm | 0,6 mm | ✓ | 23 Ga | 10000 | | |
| F-31854 | 35 mm | 0,6 mm | 0,6 mm | ✓ | 23 Ga | 10000 | | |
| F-32920 | 45 mm | 0,6 mm | 0,6 mm | ✓ | 23 Ga | 10000 | | |
| F-32933 | 50 mm | 0,6 mm | 0,6 mm | ✓ | 23 Ga | 10000 | | |



F-31896

| Art.nr. | Lengte | Breedte | Dikte | Gegalvaniseerd | Draadkaliber | Stuks/verpakking | Prijs excl. btw | Prijs incl. btw |
|---------|--------|---------|---------|----------------|--------------|------------------|-----------------|-----------------|
| F-31867 | 15 mm | 1,2 mm | 1,0 mm | ✓ | 18 Ga | 5000 | | |
| F-31870 | 20 mm | 1,2 mm | 1,0 mm | ✓ | 18 Ga | 5000 | | |
| F-31883 | 25 mm | 1,2 mm | 1,0 mm | ✓ | 18 Ga | 5000 | | |
| F-31896 | 30 mm | 1,2 mm | 1,0 mm | ✓ | 18 Ga | 5000 | | |
| F-31915 | 35 mm | 1,2 mm | 1,0 mm | ✓ | 18 Ga | 5000 | | |
| F-31944 | 45 mm | 1,2 mm | 1,0 mm | ✓ | 18 Ga | 5000 | | |
| F-31957 | 50 mm | 1,2 mm | 1,0 mm | ✓ | 18 Ga | 5000 | | |
| F-32946 | 55 mm | 1,25 mm | 1,05 mm | ✓ | 18 Ga | 5000 | | |



F-33993

| Art.nr. | Lengte | Breedte | Dikte | Gegalvaniseerd | Draadkaliber | Stuks/verpakking | Prijs excl. btw | Prijs incl. btw |
|---------|--------|---------|--------|----------------|--------------|------------------|-----------------|-----------------|
| F-33922 | 25 mm | 1,6 mm | 1,3 mm | ✓ | 16 Ga | 2000 | | |
| F-33935 | 30 mm | 1,6 mm | 1,3 mm | ✓ | 16 Ga | 2000 | | |
| F-33948 | 32 mm | 1,6 mm | 1,3 mm | ✓ | 16 Ga | 2000 | | |
| F-33951 | 35 mm | 1,6 mm | 1,3 mm | ✓ | 16 Ga | 2000 | | |
| F-33964 | 38 mm | 1,6 mm | 1,3 mm | ✓ | 16 Ga | 2000 | | |
| F-33977 | 40 mm | 1,6 mm | 1,3 mm | ✓ | 16 Ga | 2000 | | |
| F-33980 | 45 mm | 1,6 mm | 1,3 mm | ✓ | 16 Ga | 2000 | | |
| F-33993 | 50 mm | 1,6 mm | 1,3 mm | ✓ | 16 Ga | 2000 | | |
| F-34001 | 57 mm | 1,6 mm | 1,3 mm | ✓ | 16 Ga | 2000 | | |
| F-34014 | 60 mm | 1,6 mm | 1,3 mm | ✓ | 16 Ga | 2000 | | |
| F-34027 | 64 mm | 1,6 mm | 1,3 mm | ✓ | 16 Ga | 2000 | | |
| F-34056 | 50 mm | 1,6 mm | 1,3 mm | RVS | 16 Ga | 2000 | | |
| F-34069 | 64 mm | 1,6 mm | 1,3 mm | RVS | 16 Ga | 2000 | | |

ACCU AFWERKTACKERS
18 Ga



DFN350RTJ



DBN500RTJ



| | | DFN350RTJ | DBN500RTJ |
|-------------------------|-----------|--------------|--------------|
| Spanning | | 18 V | 18 V |
| Bijgeleverde accu's | | 2 x BL1850B | 2 x BL1850B |
| Kaliber | | 18 Ga | 18 Ga |
| Dikte nagel | | 1,0 x 1,2 mm | 1,0 x 1,2 mm |
| Lengte nagel | | 15-35 mm | 15-50 mm |
| Geschikt voor hard hout | | ✓ | - |
| Gewicht | | 2,1 kg | 3,2 kg |
| Prijs in € | excl. btw | | |
| | incl. btw | | |

ACCU AFWERKTACKERS
16 Ga



DBN600RTJ



DBN610ZJ



DBN601ZJ



| | | DBN600RTJ | DBN601ZJ | DBN610ZJ |
|-------------------------|-----------|--------------|--------------|--------------|
| | | | NIEUW | NIEUW |
| Spanning | | 18 V | 18 V | 18 V |
| Bijgeleverde accu's | | 2 x BL1850B | - | - |
| Kaliber | | 16 Ga | 16 Ga | 16 Ga |
| Dikte nagel | | 1,3 x 1,6 mm | 1,3 x 1,6 mm | 1,3 x 1,6 mm |
| Lengte nagel | | 25 - 64 mm | 19 - 64 mm | 32 - 64 mm |
| Geschikt voor hard hout | | - | ✓ | ✓ |
| Gewicht | | 3,4 - 3,8 kg | 2,9 - 3,3 kg | 3,0 - 3,3 kg |
| Prijs in € | excl. btw | | | |
| | incl. btw | | | |

DBN601-DBN610

- Hoog slagvermogen en hoge nagelsnelheid dankzij pneumatisch veermechanisme
- Gevoel vergelijkbaar met pneumatische machines
- Verbeterde wendbaarheid: compacter en lichter
- Anti-droogschietmechanisme
- LED verlichting
- De slanke neus zorgt voor een uitstekend zicht op het werkstuk
- DBN601 heeft een horizontaal geplaatst nagelmagazijn, terwijl dit bij model DBN610 onder een hoek van 20° geplaatst is.

DBN601-DBN610



Dankzij de BL motor gecombineerd met een pneumatisch veermechanisme wordt een hoog slagvermogen en hoge nagelsnelheden bereikt.



Sequentiële of contact modus



Geblokeerde nagels kunnen zonder gereedschap verwijderd worden



DJV184RTJ



DJV185RTJ



DJV182RTJ

Wist je dat er van DJV181 en DJ182 de voordelige uitvoeringen DJV181Z / DJV181TJ en DJV182Z / DJV182TJ bestaan? Zie p. 76-77 voor meer info!



DJV181RTJ

| | DJV184RTJ | DJV185RTJ | DJV181RTJ | DJV182RTJ |
|-----------------------|--------------------------|----------------------------|----------------------------|----------------------------|
| Spanning | 18V | 18V | 18V | 18V |
| Bijgeleverde accu's | 2 x BL1850B | 2 x BL1850B | 2 x BL1850B | 2 x BL1850B |
| BL motor | ✓ | ✓ | ✓ | ✓ |
| Aantal zaagbewegingen | 0-3000 min ⁻¹ | 800-3000 min ⁻¹ | 800-3500 min ⁻¹ | 800-3500 min ⁻¹ |
| Max. capaciteit hout | 135 mm | 135 mm | 135 mm | 135 mm |
| Slaglengte | 23 mm | 23 mm | 26 mm | 26 mm |
| Gewicht | 2,1 - 2,4 kg | 2,0 - 2,3 kg | 2,3 - 2,6 kg | 2,4 - 2,7 kg |
| Prijs in € | excl. btw | | | |
| | incl. btw | | | |



DPJ180RTJ

| | |
|---------------------|-------------|
| Spanning | 18V |
| Bijgeleverde accu's | 2 x BL1850B |
| Toerental | 6500 t.p.m. |
| Gewicht | 3,2 kg |
| Prijs in € | excl. btw |
| | incl. btw |



DKP181RTJU

DKP181RTJU

| | |
|---------------------|--------------|
| Spanning | 18V |
| Bijgeleverde accu's | 2 x BL1850B |
| Toerental | 12000 t.p.m. |
| Schaafbreedte | 82 mm |
| Max. spaanafname | 3 mm |
| Sponningdiepte | 25 mm |
| AWS | ✓ |
| Gewicht | 3,3 kg |
| Prijs in € | excl. btw |
| | incl. btw |

ACCU RECIPROZAGEN



DJR189

- Kan met één hand gebruikt worden
- Uitstekend geschikt voor het zagen in nauwe ruimten en in de hoogte
- Uitermate licht en toch zeer krachtig
- Trillingsarm (anti-vibratiesysteem met bewegend tegengewicht)

| | DJR189ZJ | DJR183RTJ | DJR186RTE | DJR187RTE | DJR188RTJ | DJR360PT2 |
|----------------------|--------------|-------------|-------------|-------------|-------------|-------------|
| Spanning | 18V | 18V | 18V | 18V | 18V | 2 x 18V |
| Bijgeleverde accu's | - | 2 x BL1850B | 2 x BL1850B | 2 x BL1850B | 2 x BL1850B | 2 x BL1850B |
| Bijgeleverde lader | - | DC18RC | DC18RC | DC18RC | DC18RC | DC18RD |
| BL-motor | ✓ | - | - | ✓ | ✓ | ✓ |
| Toerental | 0-3100 /min | 0-3300 /min | 0-2800 /min | 0-3000 /min | 0-3000 /min | 0-3000 /min |
| Slaglengthe | 22 mm | 13 mm | 32 mm | 32 mm | 20 mm | 32 mm |
| Max. capaciteit hout | 255 mm | 50 mm | 255 mm | 255 mm | 255 mm | 255 mm |
| Gewicht | 2,2 - 2,5 kg | 1,6 kg | 3,5 kg | 3,4 kg | 2,9 kg | 4,6 kg |
| Prijs in € | excl. btw | | | | | |
| | incl. btw | | | | | |

RECIPROZAAGBLADEN



| Art.nr. | Materiaal | Lengte | Tandsteek | Dikte | Geschikt voor | Stuks/verpakking | Prijs excl. btw | Prijs incl. btw |
|---------|-----------|--------|-----------|---------|--------------------------------------|------------------|-----------------|-----------------|
| B-05038 | BiM | 152 mm | 17-18 tpi | 0,9 mm | Metaal, non-ferro, kunststof | 5 | | |
| B-05044 | BiM | 152 mm | 6-11 tpi | 0,9 mm | Metaal, hout met spijkers, kunststof | 5 | | |
| P-05016 | HCS | 300 mm | 6 tpi | 1,4 mm | Hout, kunststof, gips | 5 | | |
| P-46648 | HM-TCT | 300 mm | 4,2 tpi | 1,35 mm | Holle steen, kalkzandsteen, baksteen | 1 | | |
| B-10609 | RVS | 305 mm | 3 tpi | 1,25 mm | Ijs, bevroren materiaal | 1 | | |
| B-10394 | HM-TCT | 305 mm | 2 tpi | 1,55 mm | Baksteen, gasbeton | 1 | | |
| B-52130 | HCS | 400 mm | | 1,5 mm | Isolatiemateriaal | 1 | | |

ACCU INVALCIRKELZAGEN
165 mm

18V → 18V → 36V



Geleiderail
194368-5 bij PT2J1



DSP600PT2J1

| | DSP601ZJU | DSP600PT2J1 |
|------------------------|-----------|-------------|
| Spanning | 2 x 18V | 2 x 18V |
| Bijgeleverde accu's | 0 | 2 x BL1850B |
| Zaagdiepte | 56 mm | 56 mm |
| Diameter asgat | 20 mm | 20 mm |
| AWS | ✓ | - |
| Aantal MAK PAC-koffers | 1 | 2 |
| Gewicht | 4,4 kg | 4,4 kg |
| Prijs in € | excl. btw | |
| | incl. btw | |

ACCU METAALCIRKELZAGEN



18V
LITHIUM-ION



DCS552RTJ

DCS553RTJ

| | DCS552RTJ | DCS553RTJ |
|---------------------|-------------|-------------|
| Spanning | 18V | 18V |
| Bijgeleverde accu's | 2 x BL1850B | 2 x BL1850B |
| BL-motor | - | ✓ |
| Ø zaagblad | 136 mm | 150 mm |
| Zaagdiepte (90°) | 50,5 mm | 57,5 mm |
| Gewicht | 2,4 kg | 3,0 kg |
| Prijs in € | excl. btw | |
| | incl. btw | |

ACCU CIRKELZAGEN



18V → 18V → 36V

18V
LITHIUM-ION

Wist je dat er van DHS680 de voordelige uitvoeringen DHS680Z en DHS680TJ bestaan? Zie p. 76-77 voor meer info!



DHS680RTJ



DHS782PT2J

DHS782, DHS783 & DHS900 passen rechtstreeks op geleiderail

PROMO

DHS680RTJ
GRATIS 3e accu 5Ah
BL1850B



DHS660RTJ



DHS900Z

PROMO

| | DSS501RTJ | DHS680RTJ | DHS660RTJ | DHS661RTJU | DHS630RTJ | DHS710PT2J | DHS782PT2J | DHS783TJU | DHS900Z |
|---------------------|-------------|-------------|-------------|-------------|-------------|-------------|-------------|-------------|---------|
| Spanning | 18V | 18V | 18V | 18V | 18V | 2 x 18V | 2 x 18V | 2 x 18V | 2 x 18V |
| Bijgeleverde accu's | 2 x BL1850B | 2 x BL1850B | 2 x BL1850B | 2 x BL1850B | 2 x BL1850B | 2 x BL1850B | 2 x BL1850B | 2 x BL1850B | - |
| BL-motor | ✓ | ✓ | ✓ | ✓ | - | - | ✓ | ✓ | ✓ |
| Zaagdiepte (90°) | 51 mm | 57 mm | 57 mm | 57 mm | 66 mm | 68,5 mm | 62,5 mm | 62,5 mm | 85 mm |
| Ø zaagblad | 136 mm | 165 mm | 165 mm | 165 mm | 165 mm | 190 mm | 190 mm | 190 mm | 235 mm |
| AWS | - | - | - | ✓ | - | - | - | ✓ | ✓ |
| Gewicht | 2,7 kg | 3,3 kg | 3,4 kg | 3,4 kg | 3,5 kg | 4,7 kg | 4,5 kg | 4,5 kg | 5,3 kg |
| Prijs in € | excl. btw | | | | | | | | |
| | incl. btw | | | | | | | | |

excl. Bluetooth unit

ACCU AFKORT-VERSTEKZAAG



DLS600RTE

| | |
|-----------------------------|-------------|
| Spanning | 18 V |
| Bijgeleverde accu's | 2 x BL1850B |
| Ø zaagblad | 165 mm |
| Max. zaagcapaciteit bij 90° | 46 x 92 mm |
| Gewicht | 6,6 kg |
| Prijs in € | excl. btw |
| | incl. btw |

EFFICUT

Fijner, sneller en efficiënter snijden



Scan mij voor meer info!



Meer zaagsneden per batterijlading



Snel zagen



Langere levensduur



Zuivere zaagsnede



ACCU TELESCOPISCHE AFKORT-VERSTEKZAGEN



DXT

Deep and Exact Cutting Technology

De gepatenteerde constructie met drevoudige tandwieloverbrenging en uitsparing achter de flens laat toe om een groter deel van het zaagblad te benutten. Daardoor kunnen ook hoge plinten verticaal of in verstek afgekort worden.



DLS714N



DLS211



DLS714NPT2 DLS111ZU DLS211ZU

| | | | |
|---------------------|-------------|----------|----------|
| Spanning | 2 x 18 V | 2 x 18 V | 2 x 18 V |
| Bijgeleverde accu's | 2 x BL1850B | 0 | 0 |
| Ø Zaagblad | 190 mm | 260 mm | 305 mm |
| Zaagdiepte (90°) | 52 mm | 91 mm | 107 mm |
| Zaagbreedte (90°) | 300 mm | 310 mm | 363 mm |
| DXT | - | ✓ | ✓ |
| AWS | - | ✓ | ✓ |
| Gewicht | 13,0 kg | 27,3 kg | 30,7 kg |
| Prijs in € | excl. btw | | |
| | incl. btw | | |

ACCU MENGER



Ideaal voor het mengen van vloeistoffen, verf en lichte lijmsorten.



INCLUSIEF BATTERIJCOVER

2 MECHANISCHE SNELHEDEN

DUT130RTE

| | |
|---------------------|-----------------------|
| Spanning | 18 V |
| Bijgeleverde accu's | 2 x BL1850B |
| Diameter mengblad | 165 mm |
| Aansluiting | M12-M14 |
| Toerental | 0-350 / 0-1300 t.p.m. |
| Gewicht | 2,5 kg |
| Prijs in € | excl. btw |
| | incl. btw |

ACCU LANGNEKSCHUURMACHINE 225 MM



Accessoires

Steunschijf

| Type | Ref. | Prijs excl. btw | Prijs incl. btw |
|--------|----------|-----------------|-----------------|
| Zacht | 199939-3 | | |
| Medium | 199940-8 | | |
| Hard | 199938-5 | | |

Schuurschijf 225 mm (per 25)

| Korrel | Ref. | Prijs excl. btw | Prijs incl. btw |
|--------|---------|-----------------|-----------------|
| P40 | B-68389 | | |
| P80 | B-68395 | | |
| P120 | B-68404 | | |
| P180 | B-68410 | | |
| P220 | E-02381 | | |
| P320 | B-68426 | | |



Telescopische buis
De totale lengte van de machine kan aangepast worden van 1100 tot 1520 mm



Verlengstuk
Met het optionele verlengstuk met steun (199937-7) kan langer comfortabel in de hoogte gewerkt worden.



De beschermkap van de DSL800 heeft één rechte kant, dat laat toe dicht langs een muur of plafond te bewegen.



De beschermkap van de DSL801 is volledig rond, dit is gunstig voor de stofafvoer.

DSL800ZU DSL801ZU

| | | |
|-----------------------|------------------|------------------|
| Spanning | 18 V | 18 V |
| Bijgeleverde accu's | 0 | 0 |
| AWS | ✓ | ✓ |
| Toerental onbelast | 1000-1800 t.p.m. | 1000-1800 t.p.m. |
| Diameter schuurschijf | 225 mm | 225 mm |
| Lengte | 1100 -1520 mm | 1100 -1520 mm |
| Gewicht | 4,8 kg | 4,8 kg |
| Prijs in € | excl. btw | |
| | incl. btw | |

ACCU GIPSFREES



DCO181Z

| | |
|---------------------|---------------------------|
| Spanning | 18 V |
| Bijgeleverde accu's | 0 |
| Toerental | 0 - 32000 t.p.m. |
| AWS | ✓ excl. Bluetooth unit |
| BL-Motor | ✓ |
| Gewicht | 1,4 kg |
| Prijs in € | excl. btw |
| | incl. btw |

ACCU GIPSZAAG



DSD180ZJ

| | |
|---------------------|-----------|
| Spanning | 18 V |
| Bijgeleverde accu's | 0 |
| Slaglengte | 6 mm |
| Gewicht | 1,7 kg |
| Prijs in € | excl. btw |
| | incl. btw |

ACCU SCHROEFAUTOMATEN



DFR453 / DFR552

De DFR453ZJ en DFR552ZJ hebben in vergelijking met DFR452 en DFR551 een lagere snelheid en meer koppel, ideaal voor het schroeven in materiaal dat meer weerstand biedt zoals hout. De DFR452/DFR551 zijn best geschikt voor het schroeven op metal stud of zachtere materialen.



DFR453ZJ



DFR551RTJ

"Push Drive"-technologie: de motor start automatisch wanneer de neus van de machine tegen de ondergrond wordt gedrukt.



| | DFR550ZJ | DFR750Z | DFR453ZJ | DFR552ZJ | DFR452ZJ | DFR452RTJ | DFR551ZJ | DFR551RTJ |
|--------------------------|-------------|-------------|-------------|-------------|-------------|-------------|-------------|-------------|
| Spanning | 18V | 18V | 18V | 18V | 18V | 18V | 18V | 18V |
| Bijgeleverde accu's | 0 | 0 | 0 | 0 | 0 | 2 x BL1850B | 0 | 2 x BL1850B |
| Toerental | 4000 t.p.m. | 4000 t.p.m. | 4500 t.p.m. | 4500 t.p.m. | 6000 t.p.m. | 6000 t.p.m. | 6000 t.p.m. | 6000 t.p.m. |
| BL motor | - | - | ✓ | ✓ | ✓ | ✓ | ✓ | ✓ |
| Ø Gipsplaatschroef | 4,0 mm | 4,0 mm | 3,5-4,2 mm | 3,5-4,2 mm | 3,5-4,2 mm | 3,5-4,2 mm | 3,5-4,2 mm | 3,5-4,2 mm |
| Schroeflengte | 25-55 mm | 45-75 mm | 20-41 mm | 20-55 mm | 20-41 mm | 20-41 mm | 25-55 mm | 25-55 mm |
| "Push drive" technologie | - | - | ✓ | ✓ | ✓ | ✓ | ✓ | ✓ |
| Gewicht | 2,1 kg | 2,1 kg | 2,2 kg | 2,2 kg | 2,2 kg | 2,2 kg | 2,2 kg | 2,2 kg |
| Prijs in € | excl. btw | | | | | | | |
| | incl. btw | | | | | | | |

SCHROEVEN OP LINT

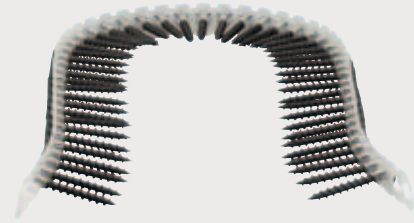
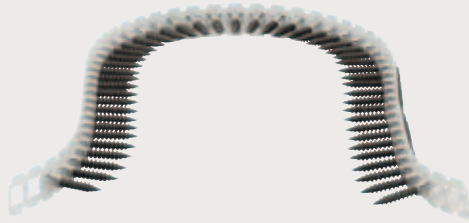

| | F-30913 | F-30926 | F-31153 | F-31166 | F-30939 | F-30942 | F-30955 | F-31179 | F-31182 | F-31140 |
|--------------------|--|--------------|--------------|--------------|--------------|--|--------------|--------------|--------------|--------------|
| Gebruik | Gipsplaatschroeven op lint (fijne draad) voor gebruik op metal studs | | | | | Gipsplaatschroeven op lint (groeve draad) voor gebruik op hout | | | | |
| Dikte (mm) | 3,9 | 3,9 | 3,9 | 3,9 | 3,9 | 3,9 | 3,9 | 3,9 | 3,9 | 3,9 |
| Lengte (mm) | 25 | 30 | 35 | 41 | 45 | 55 | 30 | 35 | 41 | 55 |
| Bitmaat | PH2 | PH2 | PH2 | PH2 | PH2 | PH2 | PH2 | PH2 | PH2 | PH2 |
| Afwerking | gefosfateerd | gefosfateerd | gefosfateerd | gefosfateerd | gefosfateerd | gefosfateerd | gefosfateerd | gefosfateerd | gefosfateerd | gefosfateerd |
| Schroeven per doos | 1000 | 1000 | 1000 | 1000 | 1000 | 1000 | 1000 | 1000 | 1000 | 1000 |
| Prijs in € | excl. btw | | | | | | | | | |
| | incl. btw | | | | | | | | | |

ACCU SCHROEVENDRAAIERS

Duw-aandraaistand ("Push drive")



In de duw-aandraaistand gaan de motor en de schroefkop automatisch draaien wanneer er druk op wordt uitgeoefend.



DFS452FJX2

DFS250RTJ

| | DFS250RTJ | DFS452RAJ | DFS452FJX2 |
|--------------------------|---------------|---------------|---------------|
| Spanning | 18V | 18V | 18V |
| Bijgeleverde accu's | 2 x BL1850B | 2 x BL1820B | 2 x BL1830B |
| Toerental | 0-2500 t.p.m. | 0-4000 t.p.m. | 0-4000 t.p.m. |
| Incl. schroeflintadapter | - | - | ✓ |
| Schroeflengte | - | - | 25-55 mm |
| "Push drive" technologie | - | ✓ | ✓ |
| Gewicht | 1,5 kg | 1,5 kg | 1,5 kg |
| Prijs in € | excl. btw | | |
| | incl. btw | | |



Afzonderlijke aan/uit en vergrendelingsknop



| | | DRT52Z |
|-------------------------|-----------|-------------------------|
| Spanning | | 18 V |
| Bijgeleverde accu's | | - |
| Max. induikdiepte | | 35 mm |
| Toerental onbelast | | 30000 min ⁻¹ |
| Ø spantang - bereik | | 6 mm |
| Ø spantang - inbegrepen | | 6 mm |
| Gewicht | | 1,3 - 1,6 kg |
| Prijs in € | excl. btw | |
| | incl. btw | |

DRT52Z

- Budgetvriendelijk model met prestaties die een gesnoerd model evenaren
- Efficiënte BL motor
- Met aan/uit schakelaar en afzonderlijke knop voor het in-of uitschakelen van de standby-mode met led indicatie, dit voorkomt onbedoeld starten
- Geleverd met trimgeleider, parallel-/cirkelgeleider en kopieerring.



| | | DRT50ZJX3 | DRT50RTJX3 |
|-------------------------|-----------|----------------------|----------------------|
| Spanning | | 18 V | 18 V |
| Bijgeleverde accu's | | 0 | 2 x BL1850B |
| Max. induikdiepte | | 35 mm | 35 mm |
| Toerental onbelast | | 10.000-30.000 t.p.m. | 10.000-30.000 t.p.m. |
| Ø spantang - bereik | | 6 - 8 mm | 6 - 8 mm |
| Ø spantang - inbegrepen | | 6 mm, 8 mm | 6 mm, 8 mm |
| Gewicht | | 2,1 kg | 2,1 kg |
| Prijs in € | excl. btw | | |
| | incl. btw | | |

ACCU MULTITOOL



DTM51



STARLOCK



Gereedschapsloze accessoirewissel

- Compatibel met OIS en Starlock (niet met Starlock Plus en Starlock Max).
- Inclusief: set van 9 accessoires, 30 schuurvellen, 1 afzuigset

DTM52



incl. accessoires

- Compatibel met Starlock, Starlock Plus en Starlock Max accessoires, ideaal voor de zwaardere toepassingen.
- Grote oscillatiehoek van 1,8° links/rechts
- Zeer lage trillingswaarden dankzij AVT technologie
- Kleine greepomtrek en laag gewicht



Wist je dat er van DTM51 de voordelige uitvoeringen DTM51Z en DTM51T1JX2 bestaan? Zie p. 68-69 voor meer info

STARLOCK STARLOCKPLUS STARLOCKMAX

| | DTM51RTJX2 | DTM52RTJX1 |
|----------------------|-----------------|---------------------------------------|
| Spanning | 18 V | 18 V |
| Bijgeleverde accu's | 2 x BL1850B | 2 x BL1850B |
| BL motor | - | ✓ |
| Oscillatiefrequentie | 6000-20000 /min | 10000-20000 /min |
| Oscillatiehoek | 3,2° | 3,6° |
| Opname | OIS, Starlock | Starlock, Starlock Plus, Starlock Max |
| Gewicht | 2,0 kg | 1,7 kg |
| Prijs in € | excl. btw | |
| | incl. btw | |

OPTIONELE ACCESSOIRES



| Art.nr. | Omschrijving | Bevat | Prijs excl. btw | Prijs incl. btw |
|---------|-------------------|--|-----------------|-----------------|
| B-67496 | Starlock tegelset | <ul style="list-style-type: none"> • Invalzaagblad TMA058 • Schrapper TMA065 • Segmentzaagblad TMA069 • Schuurplateau TMA073 | | |



| | | | | |
|---------|-----------------------|--|--|--|
| E-16994 | Starlock renovatieset | <ul style="list-style-type: none"> • Invalzaagblad TMA047 • Invalzaagblad TMA049 • Schrapper TMA065 • Schuurplateau TMA073 • Schuurpad TMA078 | | |
|---------|-----------------------|--|--|--|

ACCU HANDPALMVLAKSCHUURMACHINES



DBO480: standaard met extra driehoekszool



| | | DBO480RTJ | DBO481RTJ | DBO482RTJ | DBO484ZJ |
|-------------------------|-----------|-------------------------------|-------------------------------|-------------------------------|-------------------------------|
| Spanning | | 18 V | 18 V | 18 V | 18 V |
| Bijgeleverde accu's | | 2x BL1850B | 2x BL1850B | 2x BL1850B | - |
| Afmetingen schuurvoet | | 112 mm x 102 mm | 112 mm x 102 mm | 112 mm x 102 mm | 112 mm x 102 mm |
| Papierbevestiging | | Klem/Velcro | Klem | Klem | Klem/Velcro |
| Materiaal schuurvoet | | Kunststof | Kunststof | Aluminium | Aluminium |
| Aantal schuurbewegingen | | 22000/28000 min ⁻¹ | 22000/28000 min ⁻¹ | 22000/28000 min ⁻¹ | 22000/28000 min ⁻¹ |
| Schuuruitslag | | 1,5 mm | 1,5 mm | 1,5 mm | 1,5 mm |
| AWS | | - | - | ✓ | ✓ |
| Gewicht | | 1,4-1,8 kg | 1,4-1,8 kg | 1,4-1,8 kg | 1,4-1,8 kg |
| Prijs in € | excl. btw | | | | |
| | incl. btw | | | | |

ACCU VLAKSCHUURMACHINES



| | | DBO380RTJ | DBO381ZJU | DBO382ZJ |
|-------------------------|-----------|------------------------------------|------------------------------------|------------------------------------|
| Spanning | | 18 V | 18 V | 18 V |
| Bijgeleverde accu's | | 2x BL1850B | - | - |
| Afmetingen schuurvoet | | 92 mm x 185 mm | 92 mm x 185 mm | 92 mm x 185 mm |
| Papierbevestiging | | Klem | Klem | Klem/velcro |
| Materiaal schuurvoet | | Aluminium | Aluminium | Aluminium |
| Aantal schuurbewegingen | | 8000/16000/24000 min ⁻¹ | 8000/16000/24000 min ⁻¹ | 8000/16000/24000 min ⁻¹ |
| Schuuruitslag | | 2,0 mm | 2,0 mm | 2,0 mm |
| AWS | | - | ✓ | - |
| Gewicht | | 1,9 - 2,2 kg | 1,9 - 2,2 kg | 1,9 - 2,2 kg |
| Prijs in € | excl. btw | | | |
| | incl. btw | | | |

ACCU EXCENTRISCHE POLIJSTMACHINE



Vrije rotatie en geforceerde rotatie

| | | DPO500Z | DPO600Z |
|----------------------|-----------|---------------------------|---------------------------|
| Spanning | | 18 V | 18 V |
| Bijgeleverde accu's | | 0 | 0 |
| Oscillatiefrequentie | | 0-13600 min ⁻¹ | 0-13600 min ⁻¹ |
| Schuurvoet | | 125 mm | 150 mm |
| Schuuruitslag | | 5,5 mm | 5,5 mm |
| Gewicht | | 3,1 kg | 3,1 kg |
| Prijs in € | excl. btw | | |
| | incl. btw | | |

ACCU BANDSCHUURMACHINE 9 MM



Richtbare led en zijhandgreep



Werkbereik 90° met uiterste stand 160° voor het opbergen.

Hoog gebruikscomfort en perfecte balans door centrale plaatsing van de motor



DBS180ZJ

| | |
|---------------------|------------------|
| Spanning | 18 V |
| Bijgeleverde accu's | - |
| Bandsnelheid | 600 - 1700 m/min |
| Schuurband | 9 x 533 mm |
| Gewicht | 1,8 - 2,1 kg |
| Prijs in € | excl. btw |
| | incl. btw |

ACCU EXCENTRISCHE SCHUURMACHINE 125 MM



DBO180RTJ

| | |
|-------------------------|--------------------------------|
| Spanning | 18 V |
| Bijgeleverde accu's | 2 x BL1850B |
| Diameter schuurvoet | 125 mm |
| Aantal schuurbewegingen | 14000 - 22000 mm ⁻¹ |
| Schuuruitslag | 2,8 mm |
| Gewicht | 1,7 kg |
| Prijs in € | excl. btw |
| | incl. btw |

ACCU SCHUURPOLIJSTMACHINE 75 MM



Polijsten
Steunschijf met velcro opname voor polijst toepassingen.

Compact
Uiterst compacte machine met de handgreep kort bij de schijf voor een optimale controle.

DPV300RTJ

- Zeer compacte machine ideaal voor het schuren en polijsten van kleine oppervlakken.
- Twee mechanische versnellingen en traploze snelheidsregeling.
- Geleverd met velcro steunschijf voor het polijsten en een Roloc™ opname voor schuurtoepassingen.



Schuren
Roloc™ compatibele opname voor schuurtoepassingen.

● **Accessoires**

Steunschijf

| Referentie | Omschrijving |
|------------|---|
| E-07412 | Schuurschijf aluminiumoxide 50 mm A60 (25 st.) |
| E-07428 | Schuurschijf aluminiumoxide 50 mm A80 (25 st.) |
| E-07434 | Schuurschijf aluminiumoxide 50 mm A120 (25 st.) |
| E-07440 | Schuurschijf zirconium 50 mm Z60 (25 st.) |
| E-07456 | Schuurschijf zirconium 50 mm Z80 (25 st.) |
| E-07462 | Vliesschijf zirconium Grof / Hard 50 mm (25 st.) |
| E-07478 | Vliesschijf zirconium Medium / Hard 50 mm (25 st.) |
| E-07484 | Vliesschijf zirconium Fijn / Hard 50 mm (25 st.) |
| E-07490 | Vliesschijf zirconium Medium/ Zacht 50 mm (25 st.) |
| E-07509 | Vliesschijf zirconium Fijn/Zacht 50 mm (25 st.) |
| E-07515 | Vliesschijf zirconium Zeer fijn/ Zacht 50 mm (25 st.) |

Prijs excl. btw Prijs incl. btw

DPV300RTJ

| | |
|----------------------|--------------------------|
| Bijgeleverde accu's | 2 x BL1850 |
| Capaciteit polijsten | 80 mm |
| Capaciteit schuren | 50 mm |
| Toerental polijsten | 0-2800 min ⁻¹ |
| Toerental schuren | 0-9500 min ⁻¹ |
| Gewicht | 1,3 kg |
| Prijs in € | excl. btw |
| | incl. btw |

ACCU BANDZAGEN



DPB180Z

Aluminium
behuizing



DPB183Z



DPB184Z

| | DPB180Z | DPB184Z | DPB183Z |
|------------------------|--------------|------------|------------|
| Spanning | 18 V | 18 V | 18 V |
| Bijgeleverde accu's | - | - | - |
| Bijgeleverde lader | - | - | - |
| Max. bandsnelheid | 162 m/min | 192 m/min | 192 m/min |
| Capaciteit stalen buis | 120 x 120 mm | 51 x 51 mm | 66 x 66 mm |
| BL-motor | - | ✓ | ✓ |
| Gewicht | 6,8 kg | 3,2 kg | 3,8 kg |
| Prijs in € | excl. btw | | |
| | incl. btw | | |

ACCU METAALAFKORTMACHINE



DLW140PG2

Gereedschapsloze
(hoek)-verstelling van
de geleider.

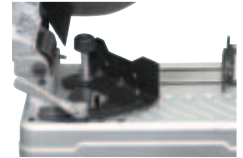

| | DLW140Z | DLW140PG2 |
|---------------------|-------------|-------------|
| Spanning | 2 x 18 V | 2 x 18 V |
| Bijgeleverde accu's | 0 | 2 x BL1860B |
| Toerental onbelast | 3800 t.p.m. | 3800 t.p.m. |
| Diameter schijf | 355 mm | 355 mm |
| Gewicht | 16,9 kg | 16,9 kg |
| Prijs in € | excl. btw | |
| | incl. btw | |

ACCU BLINDKLINKNAGELPISTOLEN



DRV150Z



Scan deze code
voor uitgebreide
technische info.

| | DRV150Z | DRV250Z |
|----------------------------------|---------------|------------|
| Bijgeleverde accu's/lader | - | - |
| Trekkraft | 10 kN | 20 kN |
| Compatibel met blindklinknagel Ø | 24/32/40/48mm | 48/60/64mm |
| Slaglengthe | 25 mm | 30 mm |
| Gewicht | 1,9 kg | 2,1 kg |
| Prijs in € | excl. btw | |
| | incl. btw | |

ACCU AFKORTSLIJPMACHINES

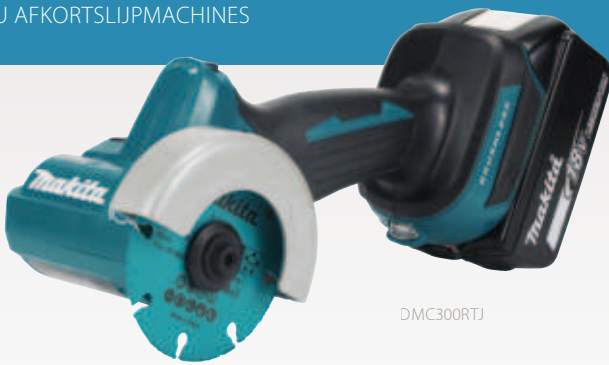

DMC300RTJ

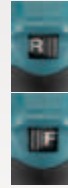

DMC300

- Zeer compacte slijpmachine, ideaal voor het zagen op moeilijk bereikbare plaatsen
- Goed uitgebalanceerd, kan veilig met één hand gebruikt worden
- De draairichting is omkeerbaar
- Stofkap met aansluiting voor stofafzuiging standaard bijgeleverd
- Voor het zagen in staal, keramiek en kunststoffen



D-74815-5 D-77263 D-74837

Accessoires

| Ref | Type | Prijs excl. btw | Prijs incl. btw |
|-----------|---|-----------------|-----------------|
| D-74815-5 | Doorslijpschijf voor RVS 76mm (5 stuks) | | |
| D-77263 | Diamantschijf 76x1,4x10mm | | |
| D-74837 | Carbide multi-snijschijf 76x10mm | | |

| | DMC300ZJ | DMC300RTJ |
|---------------------|---|---|
| Spanning | 18 V | 18 V |
| Bijgeleverde accu's | - | 2x BL1850B |
| Lader | - | DC18RC |
| Ø schijf | 76 mm | 76 mm |
| Toerental onbelast | 20000 min ⁻¹ | 20000 min ⁻¹ |
| Max. zaagdiepte | met stofkap: 13,5 mm zonder stofkap: 16,0 mm | met stofkap: 13,5 mm zonder stofkap: 16,0 mm |
| Gewicht | 1,2 - 1,7 kg | 1,2 - 1,7 kg |
| Prijs in € | excl. btw | |
| | incl. btw | |

ACCU DOORSLIJPER



DCE090T2X1

Maximale zaagdiepte 88 mm



Accessoires

| Ref | Type | Prijs excl. btw | Prijs incl. btw |
|------------|---|-----------------|-----------------|
| E-03006-25 | Doorslijpschijf RVS (25 st.) 230 x 2,0 x 22,23 mm | | |
| E-02967 | Diamantschijf 230 mm x 2,4 x 22,23 mm | | |

De gesegmenteerde diamantschijf E-02967 werd speciaal ontwikkeld voor het gebruik met een accu doorslijper. De diamantkorrels zijn gelijkmatig verdeeld en volgens een speciaal V-vormig patroon ingebed. Daardoor blijft de schijf continu scherp en zijn de zaagprestaties optimaal.

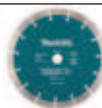

| | DCE090ZXT | |
|---------------------|------------------------|--|
| Spanning | 2 x 18 V | |
| Bijgeleverde accu's | 0 | |
| Lader | - | |
| Ø schijf | 230 mm | |
| Toerental onbelast | 6600 min ⁻¹ | |
| Max. zaagdiepte | 88 mm | |
| Max. schijfdikte | 3,0 mm | |
| Gewicht | 5,6 - 6,3 kg | |
| Prijs in € | excl. btw | |
| | incl. btw | |

ACCU DIAMANTZAAG 125 MM



Inclusief 2 stofkappen, voor droog en nat gebruik

Ideaal voor afwerking (steen, beton, keramiek)

Kantelbaar tot 45°

geleverd zonder schijf

| | DCC501RTJ | |
|---------------------|------------------------|--|
| Spanning | 18 V | |
| Toerental onbelast | 8500 min ⁻¹ | |
| AWS | ✓ excl. Bluetooth unit | |
| Diameter asgat | 20 mm | |
| Bijgeleverde accu's | 2 x BL1850B | |
| Gewicht | 2,7 kg | |
| Prijs in € | excl. btw | |
| | incl. btw | |

ACCU HAAKSE SLIJERS 125 MM

ADT AFT **BL MOTOR**

Wist je dat er van DGA506 en DGA508 de voordelige uitvoeringen DGA506Z / DGA506T1J en DGA508Z / DGA508T1J bestaan? Zie p. 68-69 voor meer info!

Promo DGA506T1J en DGA508T1J: gratis 10 doorslijpschijven D-18770-10 zie p. 77



DGA506RTJ

DGA518RTJU

Promo DGA506RTJ en DGA508RTJ: gratis extra accu BL1850B

| | DGA506RTJ | DGA508RTJ | DGA513RTJ | DGA517RTJ | DGA518RTJU |
|-----------------------|------------------------------------|---------------------------------------|------------------------------------|---------------------------------------|---------------------------------------|
| Spanning | 18V | 18V | 18V | 18V | 18V |
| Bijgeleverde accu's | 2 x BL1850B | 2 x BL1850B | 2 x BL1850B | 2 x BL1850B | 2 x BL1850B |
| Ø schijf | 125 mm | 125 mm | 125 mm | 125 mm | 125 mm |
| Heropstartbeveiliging | ✓ | ✓ | ✓ | ✓ | ✓ |
| Elektrische rem | ✓ | ✓ | ✓ | ✓ | ✓ |
| Regelbaar toerental | - | - | ✓ | ✓ | ✓ |
| AWS | - | - | - | - | ✓ |
| Schakelaar | Schuifschakelaar met vergrendeling | Lepelschakelaar, zonder vergrendeling | Schuifschakelaar met vergrendeling | Lepelschakelaar, zonder vergrendeling | Lepelschakelaar, zonder vergrendeling |
| Gewicht | 2,5 kg | 2,5 kg | 2,5 kg | 2,5 kg | 2,5 kg |
| Prijs in € | excl. btw | | | | |
| | incl. btw | | | | |

BESCHERMKAP MET STOF AFZUIGING VOOR HAAKSE SLIJERS



230 mm



125 mm

| | 196845-3 | 198440-5 |
|------------------|-----------|----------|
| Diameter stofkap | 125 mm | 230 mm |
| Max. zaagdiepte | 20 mm | 60 mm |
| Prijs in € | excl. btw | |
| | incl. btw | |

ACCU STEPELSLIJPER



DGD800RTJ

| | |
|-------------------------|--------------|
| Spanning | 18V |
| Bijgeleverde accu's | 2 x BL1850B |
| Toerental | 25000 t.p.m. |
| Ø spantang - bereik | 6 - 8 mm |
| Ø spantang - inbegrepen | 6 mm |
| Gewicht | 2,1 kg |
| Prijs in € | excl. btw |
| | incl. btw |

ACCU HAAKSE SLIJERS 180-230 MM

ADT AFT **18V + 18V** **36V**



DGA701ZKU

| | DGA701ZKU | DGA900ZK | DGA901PGZU |
|---------------------|-----------|----------|-------------|
| Spanning | 2 x 18V | 2 x 18V | 2 x 18V |
| Bijgeleverde accu's | 0 | 0 | 2 x BL1860B |
| Ø schijf | 180 mm | 230 mm | 230 mm |
| AWS | ✓ | - | ✓ |
| Gewicht | 5,0 kg | 5,2 kg | 5,2 kg |
| Prijs in € | excl. btw | | |
| | incl. btw | | |

ACCU HAAKSE SLIJPER 125 MM X-LOCK



DGA519RTJ



DGA521ZX1



| | DGA521ZX1 | DGA520ZX1 | DGA519ZJ | DGA519RTJ |
|-----------------------|------------------------------------|--------------------------------------|--------------------------------------|--------------------------------------|
| Spanning | 18 V | 18 V | 18 V | 18 V |
| Bijgeleverde accu's | 0 | 0 | 0 | 2 x BL1850B |
| Ø schijf | 125 mm | 125 mm | 125 mm | 125 mm |
| Toerental onbelast | 8500 min ⁻¹ | 8500 min ⁻¹ | 3000 - 8500 t.p.m. | 3000 - 8500 t.p.m. |
| Heropstartbeveiliging | ✓ | ✓ | ✓ | ✓ |
| Elektrische rem | - | ✓ | ✓ | ✓ |
| Regelbaar toerental | - | - | ✓ | ✓ |
| Type schakelaar | Schuifschakelaar met vergrendeling | Lepelschakelaar zonder vergrendeling | Lepelschakelaar zonder vergrendeling | Lepelschakelaar zonder vergrendeling |
| Gewicht | 2,4 - 3,0 kg | 2,4 - 3,0 kg | 2,5 kg | 2,5 kg |
| Prijs in € | excl. btw | | | |
| | incl. btw | | | |



Snel en veilig schijven bevestigen via een kliksysteem.



ACCESSOIRES X-LOCK

| Referentie | Type | Prijs excl. btw | Prijs incl. btw |
|------------|---|-----------------|-----------------|
| E-00393 | Afbraamschijf voor metaal 125 mm x 6 x 22,23 | | |
| E-00402 | Afbraamschijf voor inox 125 mm x 6 x 22,23 | | |
| E-00418 | Doorslijpschijf voor inox 125 mm x 1,2 x 22,23 | | |
| E-02076 | Diamantdoorslijpschijf 125 mm | | |
| 191G05-4 | Beschermkap met stofafzuiging 125 mm | | |
| D-73396 | Komborstel voor metaal, gegolfde draad 75 mm x 0,3 | | |
| D-73433 | Komborstel voor metaal, gegolfde draad, vermessingd 75 mm x 0,3 | | |
| D-73346 | Komborstel voor inox, gegolfde draad 75 mm x 0,3 | | |
| D-73374 | Komborstel voor metaal, getordeerde draad 80 mm x 0,35 | | |
| D-73380 | Komborstel voor metaal, getordeerde draad 80 mm x 0,5 | | |
| D-73330 | Komborstel voor inox, getordeerde draad 80 mm x 0,5 | | |
| D-73449 | Kegelborstel voor metaal, gegolfde draad 100 mm x 0,3 | | |
| D-73411 | Schijfborstel voor metaal, getordeerde draad 115 mm x 0,5 | | |
| D-73427 | Schijfborstel voor metaal, gegolfde draad 115 mm x 0,3 | | |
| E-11776 | Doorslijpschijf TCG 125 mm x 2 x 22,23 X-Lock | | |
| E-19738 | Vacuüm gesoldeerde diamantschijf 125 mm | | |



ACCU PLAATSCHAREN



DJS130ZJ



DJS800Z



DJS131Z



DJS200Z



DJS800

- Geschikt voor het knippen van o.a. cementbeplating, brandwerende platen en geluidsisolatieplaten tot 13 mm dikte.
- Knipt vrijwel stofvrij, snel en zonder lawaai.
- De snijkop is 360° draaibaar voor knippen op moeilijk bereikbare plaatsen.

bij alle modellen kan de kop 360° gedraaid worden



DJS131

- Kan bochten en gegolfde staalplaat snijden

DJS130/DJS200

- Voor het knippen van rechte stukken met minimale vervorming

| | DJS130ZJ | DJS200Z | DJS131Z | DJS800Z |
|-----------------------|------------------------|--------------------------|--------------------------|--------------------------|
| Spanning | 18V | 18V | 18V | 18V |
| Bijgeleverde accu's | - | - | - | - |
| BL-motor | - | ✓ | ✓ | ✓ |
| Aantal zaagbewegingen | 2800 min ⁻¹ | 0-3000 min ⁻¹ | 0-3000 min ⁻¹ | 0-3000 min ⁻¹ |
| Max. dikte staal | 1,3 mm | 2,0 mm | 1,3 mm | 13 mm (vezelcement) |
| Gewicht | 2,3 - 2,6 kg | 2,2 - 2,5 kg | 2,0 - 2,3 kg | 2,1 - 2,5 kg |
| Prijs in € | excl. btw | | | |
| | incl. btw | | | |

ACCU KNABELSCHAAR



DJN161RTJ

| | |
|----------------------------|------------------------|
| Spanning | 18V |
| Bijgeleverde accu's | 2 x BL1850B |
| Max. aantal snijbewegingen | 1900 min ⁻¹ |
| Max. dikte staal | 1,6 mm |
| Gewicht | 2,2 kg |
| Prijs in € | excl. btw |
| | incl. btw |



ACCU VLECHTMACHINE



DTR180ZJ

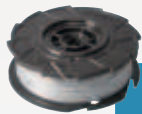

Promo DTR180ZJ :
gratis doos
gegalvaniseerde
binddraad 191A57-9



DTR181ZJ

DTR181

- Deze versie kan grotere verbindingen maken, tot bijvoorbeeld: (2 x 16 mm) + (2 x 13 mm) of 25 mm + 22 mm.

Optioneel accessoire:
handgreep 191M27-0



| | | DTR180ZJ | DTR181ZJ |
|---------------------|-----------|--|--|
| Spanning | | 18 V / 14,4 V | 18 V / 14,4 V |
| Bijgeleverde accu's | | 0 | 0 |
| Vlechtcapaciteit | | 10 mm + 10 mm (2 x 13 mm) + (2 x 13 mm) | 16 mm + 16 mm (2 x 16 mm) + (2 x 13 mm) |
| Draaddikte | | 0,8 mm | 0,8 mm |
| Modus | | Enkelvoudig/continu | Enkelvoudig/continu |
| Gewicht | | 2,3 kg | 2,3 kg |
| Prijs in € | excl. btw | | |
| | incl. btw | | |



Polyester draad: 191J59-9
(100 m, Ø 0,8 mm) 50 stuks/doos



Vlecht draad gegalvaniseerd: 191A57-9
(100 m, Ø 0,8 mm) 50 stuks/doos



Vlecht draad staal: 199137-9
(100 m, Ø 0,8 mm) 50 stuks/doos

ACCU VACUÛMPOMP



DVP181

- Kan continu werken dankzij twee accu's in parallel
- Tweetraps pomp met hoog debiet



DVP181ZK



DVP180Z

| | | DVP180Z | DVP181ZK |
|-------------------------|-----------|--------------------------------------|---------------------------------------|
| Spanning | | 18 V | 18 V, 2 accu's in parallel |
| Bijgeleverde accu/lader | | - | - |
| Compressor | | ééntraps olieafgedichte schottenpomp | Tweetraps olieafgedichte schottenpomp |
| Debiet | | 60 l/min | 113 l/min |
| Eindvacuüm | | 20 Pa (150 micron) | 3 Pa (22,5 micron) |
| Gewicht | | 2,9 kg | 8,2 kg |
| Prijs in € | excl. btw | | |
| | incl. btw | | |

ACCU KITPISTOOL



INCLUSIEF
kokerhouder
600 ml bij
DCG180RAX



DCG180RA
300 ml

DCG180RAX

| | | DCG180RA | DCG180RAX |
|-----------------------|-----------|-------------|-------------|
| Spanning | | 18 V | 18 V |
| Bijgeleverde accu's | | 1 x BL1820B | 1 x BL1820B |
| Max. spuitdruk | | 5000 N | 5000 N |
| Max. extrusiesnelheid | | 0-28 mm/s | 0-28 mm/s |
| Gewicht | | 2,1 kg | 2,4 kg |
| Prijs in € | excl. btw | | |
| | incl. btw | | |

ACCU KABELKNIPPERS



- Voor het knippen van zware elektriciteitskabels on site
- Lichtgewicht ontwerp en uitstekende manoeuvreerbaarheid
- Gesloten en open types
- Voor het knippen van aluminium/koperkabel (DTC100, DTC101, DTC102, DTC104)
- DTC103 is ook geschikt voor het knippen van staalversterkte aluminium kabel (ASCR)
- Automatisch terugkeer van het mes na het snijden
- DTC104 heeft een zeer hoge snijkraft van 120 kN dankzij een hydraulisch systeem



| | DTC100ZK | DTC101ZK | DTC102ZK | DTC103ZK | DTC104ZK |
|------------------|---------------------------|---------------------------|---------------------------|------------|---------------------------|
| Spanning | 18 V | 18 V | 18 V | 18 V | 18 V |
| Toepassing | Aluminium/ koper kabel | Aluminium/ koper kabel | Aluminium/ koper kabel | ASCR | Aluminium/ koper kabel |
| Type | Gesloten | Open | Gesloten | Gesloten | Open |
| Maximale opening | 50 mm | 50 mm | 65 mm | 54 mm | 105 mm |
| Knipcapaciteit* | 35 - 47 mm | 35 - 47 mm | 65 mm max. | 54 mm max. | 72 - 105 mm |
| Gewicht | 2,9 kg | 3,6 kg | 3,5 kg | 5,5 kg | 10,2 - 10,5 kg |
| Prijs in € | excl. btw | | | | |
| | incl. btw | | | | |

*De exacte knipcapaciteit is afhankelijk van het type kabel: het aantal geleiders, de uitvoering (gevlochten of massief) en de dikte van de ommanteling.

ACCU KABELKRIMPTANGEN



DTC301/DTC302

- Voor het krimpen van kabelschoenen op elektriciteitskabels met grote diameter
- Hoge krimpcapaciteit tot 300 mm² (400 mm² voor model DTC302)
- Functie voor automatisch terugkeren van de cilinder



Het automatisch terugkeren van de cilinder kan in- of uitgeschakeld worden



Krimpmatrijzen voor koper en aluminium kabelschoenen (DIN46235) zijn apart verkrijgbaar



| | NIEUW | |
|-----------------|--|--|
| | DTC301ZK | DTC302ZK |
| Spanning | 18 V | 18 V |
| Toepassing | Cu/Al kabelschoenen | Cu/Al kabelschoenen |
| Perskracht | 120 kN | 120 kN |
| Slag | 31 mm | 42 mm |
| Krimpcapaciteit | Cu: ø19.5 (300mm ²) Al: ø19.5 (300mm ²) | Cu: ø22.5 (400mm ²) Al: ø19.5 (300mm ²) |
| Gewicht | 6,8 - 7,1 kg | 7,5 - 8,8 kg |
| Prijs in € | excl. btw | |
| | incl. btw | |

ACCU DRAADSTANGKNIPPERS



Voor gebruiksklaar afkorten zonder vonken



DSC102

Mobiel afkorten

DSC102ZJ



DSC121ZK

Stationair afkorten

| | DSC102ZJ | DSC121ZK |
|----------------------|-----------|------------|
| Spanning | 18 V | 18 V |
| Bijgeleverde accu's | 0 | 0 |
| Snijcapaciteit | M6/M8/M10 | M8/M10/M12 |
| Inbegrepen messenset | M8/M10 | M8 |
| Gewicht | 3,3 kg | 5,7 kg |
| Prijs in € | excl. btw | |
| | incl. btw | |

ACCU BETONIJSERZAAG



DSC251ZK

| | |
|---------------------------|-----------|
| Spanning | 18 V |
| Bijgeleverde accu's/lader | 0 |
| Snijcapaciteit | 10-25 mm |
| Gewicht | 3,9 kg |
| Prijs in € | excl. btw |
| | incl. btw |

ACCU HYDRAULISCHE BETONIJSERKNIPPERS



DSC163ZK

DSC163ZK DSC191Z

| | | |
|---------------------------|-----------|----------------|
| Spanning | 18 V | 18 V |
| Bijgeleverde accu's/lader | - | - |
| Snijcapaciteit | 3 - 16 mm | 3 - 20 mm |
| BL-motor | ✓ | - |
| Gewicht | 6,9 kg | 11,1 - 11,2 kg |
| Prijs in € | excl. btw | |
| | incl. btw | |

ACCU PONSMACHINE



DPP200ZK

| | |
|-----------------------|-----------|
| Spanning | 18 V |
| Max. diameter ponsgat | 20 mm |
| Inbegrepen Ø | 12 mm |
| Max. dikte staal | 8 mm |
| Max. dikte inox | 6 mm |
| Gewicht | 10,5 kg |
| Prijs in € | excl. btw |
| | incl. btw |

ACCU VETPOMP



Werkt met standaard 400 g patronen of vet in bulk



Debietregeling: automatisch of traag (met hoogste druk)



DGP180RT



DGP180RA

Hogedrukslang van 120 cm

| | DGP180Z | DGP180RT |
|---------------------|----------------|----------------|
| Spanning | 18V | 18V |
| Bijgeleverde accu's | - | 1 x BL1850B |
| Maximale druk | 690 bar | 690 bar |
| Debiet | 145-290 ml/min | 145-290 ml/min |
| Gewicht | 4,8 kg | 4,8 kg |
| Prijs in € | excl. btw | |
| | incl. btw | |

ACCU BETONTRILNAALDEN



DVR850Z

BETONTRILNAALDEN MET DIRECTE AANSLUITING OP HET ACCUPACK



- Voeding middels PDC draagbaar accupack (accupack niet inbegrepen)
- Zeer comfortabel werken omdat enkel de trilnaald gehanteerd moet worden.
- Compatibel met flessen met grote diameter Ø 43 mm en Ø 52 mm
- Werktijd tot 300 minuten met PDC1200



VR004C

























VR001C



| | DVR350Z | DVR450Z | DVR850Z |
|---------------------|-----------|---------|---------|
| Spanning | 18V | 18V | 18V |
| Bijgeleverde accu's | 0 | 0 | 0 |
| Lengte trilnaald | 80 cm | 120 cm | 240 cm |
| Diameter trilnaald | 25 mm | 25 mm | 25 mm |
| Gewicht | 2,0 kg | 2,3 kg | 2,4 kg |
| Prijs in € | excl. btw | | |
| | incl. btw | | |

| | VR001CZ | VR002CZ | VR003CZ | VR004CZ |
|---------------------|------------------------|------------------------|------------------------|------------------------|
| Spanning | 36V (Direct connect) | 36V (Direct connect) | 36V (Direct connect) | 36V (Direct connect) |
| Bijgeleverde accu's | - | - | - | - |
| Trilfrequentie | 1200 min ⁻¹ | 1200 min ⁻¹ | 1200 min ⁻¹ | 1200 min ⁻¹ |
| Ø trilfles | 43 mm | 43 mm | 52 mm | 52 mm |
| Lengte trilnaald | 1,5 m | 3,0 m | 1,5 m | 3,0 m |
| Autonomie (PDC1200) | 300 min | 300 min | 200 min | 200 min |
| Gewicht | 11,8 kg | 12,9 kg | 12,6 kg | 13,7 kg |
| Prijs in € | excl. btw | | | |
| | incl. btw | | | |

BESPAAR MET ONZE COMBOPACKS!

| MACHINES IN COMBOPACK 18 V | | ACCU | DC18RC | MAK-PAC | PRIJS IN € |
|---|---|---|--|---|------------|
|  |  | 2 x  BL1830B |  |  | DLX2394J |
|  |  | 3 x  BL1850B |  |  | DLX2289T3J |
|  |  | 3 x  BL1850B |  |  | DLX2189T3J |
|  |  | 2 x  BL1850B |  |  | DLX2522TJ |
|  |  | 3 x  BL1850B |  |  | DLX2236TJ1 |
|  |  | 3 x  BL1850B |  |  | DLX2434TJ |

PROMO
GRATIS hex.
Multimateriaalboren-
set E-16732





BESPAAR MET ONZE COMBOPACKS!

| | DHP486 | DHP489 | DTD153 | DHR243 | DGA506 | DHS680 | DJV181 | DTM51 |
|------------|--------|--------|--------|--------|--------|--------|--------|-------|
| DLX2507T3J | | | | | | | | |
| DLX4183T3J | | | | | | | | |
| DLX5093TJ | | | | | | | | |
| DLX5071TJ | | | | | | | | |
| DLX7030T3J | | | | | | | | |
| DLX1055JX1 | | | | | | | | |
| DLX1122JX1 | | | | | | | | |

PROMO batterij BL1850B meteen geleverd in Makpac

Combineer
voordelig met deze
aanbieding

Deze modellen bestaan
ook in een voordelige
'Z-versie' zonder accu,
lader, Makpac of andere
extra toebehoren.



DTM51T1JX2



DDF484T1J



DTD153T1J



NIEUW
DHP492T1J



DHR243T1J



Makita
5.0Ah



TR0000001 TROLLEY



| DJR188Z | DRT50ZJX3 | DBO180ZJ | DDA351ZJ | BL1850B 18 V 5,0 Ah | DC18RC | KOFFER | PRIJS IN € |
|---------|-----------|----------|----------|------------------------|---------|--------|-------------------------------------|
| | | | | 3 x | | | PROMO: Gratis B-55697 |
| | | | | 3 x | | 2 x | |
| | | | | 3 x | | 3 x | |
| | | | | 3 x | | 3 x | |
| | | | | 3 x | | 4 x | |
| | | | | 5 x | 2 x | 9 x | |
| | | | | 5 x | 2 x | 10 x | |



DHS680T1J



DTW300T1J



DJV181T1J



DJV182T1J



Extra promo
DGA506T1J &
DGA508T1J: Gratis
10 doorslijpschijven
D-18770-10

DGA506T1J



DGA508T1J



HET *LXT* -PLATFORM

DBN500ZJ

Minibradpistool
18 V

Prijs excl. BTW

Prijs incl. BTW



Makpac

DBN600ZJ

Bradpistool
18 V

Prijs excl. BTW

Prijs incl. BTW



DBO180ZJ

Excentrische
schuurmachine 18V

Prijs excl. BTW

Prijs incl. BTW



Makpac

DBO380ZJ

Vlakschuur-
machine 18V

Prijs excl. BTW

Prijs incl. BTW



Makpac

DBO381ZJU

Vlakschuur-
machine 18 V

Prijs excl. BTW

Prijs incl. BTW



Makpac

DBO480ZJ

Vlakschuurmachine
18 V

Prijs excl. BTW

Prijs incl. BTW



Makpac

DBO481ZJ

Vlakschuurmachine
18 V

Prijs excl. BTW

Prijs incl. BTW



Makpac

DBO482ZJ

Vlakschuurmachine
18 V

Prijs excl. BTW

Prijs incl. BTW



Makpac

DBS180ZJ

Bandschuurmachine
9 mm 18 V

Prijs excl. BTW

Prijs incl. BTW



Makpac

DCB200B

Verwarmd deken 18V

Prijs excl. BTW

Prijs incl. BTW



Karton

DCC501ZJ

Diamantzaag
125 mm 18 V

Prijs excl. BTW

Prijs incl. BTW



Makpac

DCG180ZK

Kitpistool 18 V

Prijs excl. BTW

Prijs incl. BTW



Koffer

DCG180ZXK

Kitpistool 18 V incl.
kokerhouder

Prijs excl. BTW

Prijs incl. BTW



Koffer

DCO181Z

Gipsfrees
18 V

Prijs excl. BTW

Prijs incl. BTW



Karton

DCS552ZJ

Metaalcirkelzaag
18 V

Prijs excl. BTW

Prijs incl. BTW



Makpac

DCS553ZJ

Metaalcirkelzaag
18 V

Prijs excl. BTW

Prijs incl. BTW



Makpac

DDA351ZJ

Haakse boor-
machine 18 V

Prijs excl. BTW

Prijs incl. BTW



Makpac

DDA450ZK

Haakse
boormachine 18 V

Prijs excl. BTW

Prijs incl. BTW



Koffer

DDF083ZJ

Boor- en schroef-
machine 1/4" 18 V

Prijs excl. BTW

Prijs incl. BTW



Makpac

DDF482ZJ

Boor- en schroef-
machine 18 V

Prijs excl. BTW

Prijs incl. BTW



Makpac

DDF484Z

Boor- en schroef-
machine 18 V

Prijs excl. BTW

Prijs incl. BTW



Karton

DDF486ZJ

Boor- en schroef-
machine 18 V

Prijs excl. BTW

Prijs incl. BTW



Makpac

DDF489ZJ

Boor- en schroef-
machine 18 V

Prijs excl. BTW

Prijs incl. BTW



Makpac

DFN350ZJ

Minibradpistool
18 V

Prijs excl. BTW

Prijs incl. BTW



Makpac

DFR452ZJ

Schroef-
automaat 18 V

Prijs excl. BTW

Prijs incl. BTW



Makpac

DFR550ZJ

Schroef-
automaat 18 V

Prijs excl. BTW

Prijs incl. BTW



Makpac

DFR551ZJ

Schroefautomaat
18 V

Prijs excl. BTW

Prijs incl. BTW



Makpac

DFR552ZJ

Schroefautomaat
18 V

Prijs excl. BTW

Prijs incl. BTW



Makpac

DFR750Z

Schroef-
automaat 18 V

Prijs excl. BTW

Prijs incl. BTW



Karton

DFS250ZJ

Schroefmachine
18 V

Prijs excl. BTW

Prijs incl. BTW



Makpac

DFS452ZJ

Schroefmachine
18 V

Prijs excl. BTW

Prijs incl. BTW



Makpac

DGA506Z

Haakse slijper
125 mm 18 V

Prijs excl. BTW

Prijs incl. BTW



Karton

DGA508Z

Haakse slijper
125 mm 18 V

Prijs excl. BTW

Prijs incl. BTW



Karton

DGA513ZJ

Haakse slijper
125 mm 18 V

Prijs excl. BTW

Prijs incl. BTW



Makpac

DGA514ZJU

Haakse slijper
125 mm 18 V

Prijs excl. BTW

Prijs incl. BTW



Makpac

DGA517ZJ

Haakse slijper
125 mm 18 V

Prijs excl. BTW

Prijs incl. BTW



Makpac

DGA519ZJ

Haakse slijper 125 mm
X-Lock 18 V

Prijs excl. BTW

Prijs incl. BTW



Makpac

DGA520ZX1

Haakse slijper
125 mm X-lock 18 V

Prijs excl. BTW

Prijs incl. BTW



Karton

DGA521ZX1

Haakse slijper
125 mm X-lock 18 V

Prijs excl. BTW

Prijs incl. BTW



Karton

DGD800ZJ

Stempelslijper 18 V

Prijs excl. BTW

Prijs incl. BTW



Makpac

DGP180Z

Vetpomp 18 V

Prijs excl. BTW

Prijs incl. BTW



Karton

DHG180ZJ

Heleluchtpistool
18 V

Prijs excl. BTW

Prijs incl. BTW



Makpac

DHG181ZJ

Heleluchtpistool
18 V

Prijs excl. BTW

Prijs incl. BTW



Makpac

DHP484ZJ

Klopboor- en
schroefmachine 18 V

Prijs excl. BTW

Prijs incl. BTW



Makpac

DHP489ZJ

Klopboor- en
schroefmachine 18 V

Prijs excl. BTW

Prijs incl. BTW



Makpac

DHP486Z

Klopboor- en
schroefmachine 18 V

Prijs excl. BTW

Prijs incl. BTW



Karton

DHR243ZJW
SDS-PLUS Boorhamer 18V + DX07
Prijs excl. BTW
Prijs incl. BTW
Makpac



DJN161ZJ
Knabbelschaar 18V
Prijs excl. BTW
Prijs incl. BTW
Makpac



DJV182Z
Decoupeerzaag 18V
Prijs excl. BTW
Prijs incl. BTW
Karton



DSD180ZJ
Gipszaag 18V
Prijs excl. BTW
Prijs incl. BTW
Makpac



DTL061ZJ
Haakse slagschroevendraaier 18V
Prijs excl. BTW
Prijs incl. BTW
Makpac



DHR264ZJ
Combihamer SDS+ 2 x 18V
Prijs excl. BTW
Prijs incl. BTW
Makpac



DJR183ZJ
Reciprozaag 18V
Prijs excl. BTW
Prijs incl. BTW
Makpac



DJV184Z
Decoupeerzaag 18V
Prijs excl. BTW
Prijs incl. BTW
Karton



DSP600ZJ
Invalcirkelzaag 165 mm 2 x 18V
Prijs excl. BTW
Prijs incl. BTW
Makpac



DTM51Z
Multitool 18V
Prijs excl. BTW
Prijs incl. BTW
Karton



DHS630ZJ
Cirkelzaag 165 mm 18V
Prijs excl. BTW
Prijs incl. BTW
Makpac



DJR186ZK
Reciprozaag 18V
Prijs excl. BTW
Prijs incl. BTW
Koffer



DJV185Z
Decoupeerzaag 18V
Prijs excl. BTW
Prijs incl. BTW
Karton



DSS501ZJ
Cirkelzaag 136 mm 18V
Prijs excl. BTW
Prijs incl. BTW
Makpac



DTM52ZJ
Multitool 18V
Prijs excl. BTW
Prijs incl. BTW
Makpac



DHS660ZJ
Cirkelzaag 165 mm 18V
Prijs excl. BTW
Prijs incl. BTW
Makpac



DJR187ZK
Reciprozaag 18V
Prijs excl. BTW
Prijs incl. BTW
Koffer



DKP181ZU
Schaaf 18V
Prijs excl. BTW
Prijs incl. BTW
Karton



DST112ZJ
Nietmachine 18V
Prijs excl. BTW
Prijs incl. BTW
Makpac



DTW1001ZJ
Slagmoersleutel 18V
Prijs excl. BTW
Prijs incl. BTW
Makpac



DHS661ZJU
Cirkelzaag 165 mm 18V
Prijs excl. BTW
Prijs incl. BTW
Makpac



DJR188ZJ
Reciprozaag 18V
Prijs excl. BTW
Prijs incl. BTW
Makpac



DLS600Z
Afkort-verstekzaag 165 mm 18V
Prijs excl. BTW
Prijs incl. BTW
Karton



DST221ZJ
Nietmachine 18V
Prijs excl. BTW
Prijs incl. BTW
Makpac



DTW1002ZJ
Slagmoersleutel 18V
Prijs excl. BTW
Prijs incl. BTW
Makpac



DHS680Z
Cirkelzaag 165 mm 18V
Prijs excl. BTW
Prijs incl. BTW
Karton



DJR189ZJ
Reciprozaag 18V
Prijs excl. BTW
Prijs incl. BTW
Makpac



DPJ180ZJ
Lamellenfrees 18V
Prijs excl. BTW
Prijs incl. BTW
Makpac



DTC301ZK
Kabelkrimp-tang 18V
Prijs excl. BTW
Prijs incl. BTW
Makpac



DTW180ZJ
Slagmoersleutel 18V
Prijs excl. BTW
Prijs incl. BTW
Makpac



DHS710ZJ
Cirkelzaag 190 mm 2 x 18V
Prijs excl. BTW
Prijs incl. BTW
Makpac



DJR360ZK
Reciprozaag 2 x 18V
Prijs excl. BTW
Prijs incl. BTW
Koffer



DPT353ZJ
Pinpistool 18V
Prijs excl. BTW
Prijs incl. BTW
Makpac



DTD153Z
Slagschroevendraaier 18V
Prijs excl. BTW
Prijs incl. BTW
Karton



DTW181ZJ
Slagmoersleutel 18V
Prijs excl. BTW
Prijs incl. BTW
Makpac



DHS782ZJ
Cirkelzaag 190 mm 2 x 18V
Prijs excl. BTW
Prijs incl. BTW
Makpac



DCV202ZL
Bodywarmer 18V (maat: L)
Prijs excl. BTW
Prijs incl. BTW
Makpac



DPV300ZJ
Schuur- en polijst-machine 75 mm 18V
Prijs excl. BTW
Prijs incl. BTW
Makpac



DTD154ZJ
Slagschroevendraaier 18V
Prijs excl. BTW
Prijs incl. BTW
Makpac



DTW190ZJ
Slagmoersleutel 18V
Prijs excl. BTW
Prijs incl. BTW
Makpac



DHS783ZJU
Cirkelzaag 190 mm 2 x 18V
Prijs excl. BTW
Prijs incl. BTW
Makpac



DCJ205ZL
Verwarmde jas 18V (maat: L)
Prijs excl. BTW
Prijs incl. BTW
Karton



DRT50ZJ
Boven- en kantenfrees 18V
Prijs excl. BTW
Prijs incl. BTW
Makpac



DTD156Z
Slagschroevendraaier 18V
Prijs excl. BTW
Prijs incl. BTW
Karton



DTW300Z
Slagmoersleutel 18V
Prijs excl. BTW
Prijs incl. BTW
Karton



DHS900Z
Cirkelzaag 235 mm 2 x 18V
Prijs excl. BTW
Prijs incl. BTW
Karton



DCJ206ZXL
Verwarmde jas 18V (maat: XL)
Prijs excl. BTW
Prijs incl. BTW
Karton



DRV150ZJ
Blindklinknagelpistool 18V
Prijs excl. BTW
Prijs incl. BTW
Makpac



DTD157ZJ
Slagschroevendraaier 18V
Prijs excl. BTW
Prijs incl. BTW
Makpac



DTW700ZJ
Slagmoersleutel 18V
Prijs excl. BTW
Prijs incl. BTW
Makpac



DHS900ZU
Cirkelzaag 235 mm 2 x 18V
Prijs excl. BTW
Prijs incl. BTW
Karton



DJV181Z
Decoupeerzaag 18V
Prijs excl. BTW
Prijs incl. BTW
Karton



DRV250ZJ
Blindklinknagelpistool 18V
Prijs excl. BTW
Prijs incl. BTW
Makpac



DTD173ZJ
Slagschroevendraaier 18V
Prijs excl. BTW
Prijs incl. BTW
Makpac



DUT130Z
Menger 18V
Prijs excl. BTW
Prijs incl. BTW
Karton





ACCU BL1021B
12Vmax 2,0 Ah



197396-9
excl. btw
incl. btw

ACCU BL1041B
12Vmax 4,0 Ah



197406-2
excl. btw
incl. btw

OPLADER DC10SB



197363-4
excl. btw
incl. btw

OPLADER DC18RE



LXT CXT
198720-9
excl. btw
incl. btw

BL1050B LI-ION ACCU 5,0
AH 12VMAX



1913G0-9
excl. btw
incl. btw

Krachtig Compact Lichtgewicht

POWERPACK 12Vmax
2 x 2,0 Ah



197658-5
excl. btw
incl. btw

POWERPACK 12Vmax
2 x 4,0 Ah



197641-2
excl. btw
incl. btw

POWERPACK LXT + CXT



199026-8
excl. btw
incl. btw

POWERPACK LXT + CXT



199029-2
excl. btw
incl. btw

COMBOPACK CXT



CLX228SAX2



CLX206SAX3



CLX400SAJ1

CLX228SAX2 CLX206SAX3 CLX400SAJ1

| | | | |
|---------------------|------------------|-----------------|--------------------------------------|
| Spanning | 10,8V | 10,8V | 10,8V |
| Bijgeleverde accu's | 3x BL1021B | 2x BL1020B | 3x BL1020B |
| Lader | DC10SB | DC10SA | DC10SA |
| Samenstelling | HP333D TD110D | TM30D DF331D | DF331D TD110D HS301D JR103D |
| Makpac | - | - | 1 |
| Prijs in € | excl. btw | | |
| | incl. btw | | |

ACCU BOOR- EN SCHROEFMACHINES

1/4" BITOPNAME



DF032DSAJ



DF033DWAJ

DF033DWAJ DF033DWMJ DF032DSAJ DF032DSMJ

| | | | | |
|---------------------|-------------|-------------|-------------|-------------|
| Spanning | 10,8 V | 10,8 V | 10,8 V | 10,8 V |
| Bijgeleverde accu's | 2 x BL1021B | 2 x BL1040B | 2 x BL1020B | 2 x BL1040B |
| Hard koppel | 30 Nm | 30 Nm | 35 Nm | 35 Nm |
| BL-motor | - | - | ✓ | ✓ |
| Gewicht | 0,9 kg | 0,9 kg | 0,9 kg | 0,9 kg |
| Prijs in € | excl. btw | | | |
| | incl. btw | | | |

ACCU BOOR- EN SCHROEFMACHINES



DF332DSAJ



DF333DNX10

DF333DNX10

| | |
|-----------------------------|-------------|
| Accu boor- & schroefmachine | DF333 |
| Bijgeleverde accu's | 2 x BL1850B |
| Bijgeleverde accu's | 1 x BL1021B |
| Lader | DC18RE |
| BL-motor | - |
| Prijs in € | excl. btw |
| | incl. btw |

DF333DWAJ DF333DWMJ DF332DSAJ DF332DSMJ

| | | | | |
|---------------------|-------------|-------------|-------------|-------------|
| Spanning | 10,8 V | 10,8 V | 10,8 V | 10,8 V |
| Bijgeleverde accu's | 2 x BL1021B | 2 x BL1041B | 2 x BL1020B | 2 x BL1040B |
| Hard koppel | 30 Nm | 30 Nm | 35 Nm | 35 Nm |
| BL-motor | - | - | ✓ | ✓ |
| Gewicht | 1,1 kg | 1,1 kg | 1,2 kg | 1,2 kg |
| Prijs in € | excl. btw | | | |
| | incl. btw | | | |

ACCU KLOPBOOR- EN SCHROEFMACHINES



HP332DSMJ



HP333DWAJ

HP333DWAJ HP332DSAJ HP332DSMJ

| | | | |
|---------------------|-------------|-------------|-------------|
| Spanning | 10,8 V | 10,8 V | 10,8 V |
| Bijgeleverde accu's | 2 x BL1021B | 2 x BL1020B | 2 x BL1040B |
| Hard koppel | 30 Nm | 35 Nm | 35 Nm |
| BL-motor | - | ✓ | ✓ |
| Gewicht | 1,1 kg | 1,1 kg | 1,3 kg |
| Prijs in € | excl. btw | | |
| | incl. btw | | |

ACCU SLAGSCHROEVENDRAAIERS



TD111DSMJ



TD110DSAJ



Assist modus voor het vlot aanzetten bij het schroeven.

TD110DSAJ TD110DSMJ TD111DZJ TD111DSAJ TD111DSMJ

| | | | | | |
|---------------------|-------------|-------------|--------|-------------|-------------|
| Spanning | 10,8 V | 10,8 V | 10,8 V | 10,8 V | 10,8 V |
| Bijgeleverde accu's | 2 x BL1020B | 2 x BL1040B | 0 | 2 x BL1020B | 2 x BL1040B |
| Max. koppel | 110 Nm | 110 Nm | 135 Nm | 135 Nm | 135 Nm |
| BL-motor | - | - | ✓ | ✓ | ✓ |
| Assist modus | - | - | ✓ | ✓ | ✓ |
| Gewicht | 1,0 kg | 1,0 kg | 1,0 kg | 1,0 kg | 1,0 kg |
| Prijs in € | excl. btw | | | | |
| | incl. btw | | | | |

SCHROEFBITSET (35 STUKS) IMPACT BLACK



Schroefbitset B-66880
35 stuks Impact Black

ACCU BOORHAMERS SDS-PLUS



HR140DSAJ

| | | HR140DSAJ | HR140DSMJ |
|---------------------|-----------|-------------|-------------|
| Spanning | | 10,8 V | 10,8 V |
| Bijgeleverde accu's | | 2 x BL1020B | 2 x BL1040B |
| Slagenergie | | 1,0 J | 1,0 J |
| Max. Ø beton | | 14 mm | 14 mm |
| BL-motor | | - | - |
| Gewicht | | 1,9 kg | 1,9 kg |
| Prijs in € | excl. btw | | |
| | incl. btw | | |

ACCU HAAKSE BOORMACHINES



DA332DSMJ



| | | DA332DSAJ | DA332DSMJ | DA333DSAJ | DA333DSMJ |
|---------------------|-----------|-------------|-------------|-------------|-------------|
| Spanning | | 10,8 V | 10,8 V | 10,8 V | 10,8 V |
| Bijgeleverde accu's | | 2 x BL1020B | 2 x BL1040B | 2 x BL1020B | 2 x BL1040B |
| Boorkop | | 1,5-10 mm | 1,5-10 mm | 1,5-10 mm | 1,5-10 mm |
| Gewicht | | 1,2 kg | 1,2 kg | 1,2 kg | 1,2 kg |
| Prijs in € | excl. btw | | | | |
| | incl. btw | | | | |

ACCU HAAKSE SLAGSCHROEVENDRAAIERS



TL064DZJ



Opname
1/4"

TL065DZJ



Opname
3/8"

| | | TL064DZJ | TL065DZJ |
|---------------------|-----------|---------------|---------------|
| Spanning | | 10,8 V | 10,8 V |
| Bijgeleverde accu's | | 0 | 0 |
| Toerental | | 0-2000 t.p.m. | 0-2000 t.p.m. |
| Gewicht | | 1,2 kg | 1,2 kg |
| Prijs in € | excl. btw | | |
| | incl. btw | | |

ACCU SLAGMOERSLEUTELS



TW141DSMJ



Reverse Auto-stop:
Rotatie stopt automatisch
wanneer de bout of moer is
losgedraaid

| | | TW140DZJ | TW140DSAJ | TW140DSMJ | TW141DZJ | TW141DSMJ | TW160DZJ | TW160DSAJ | TW160DSMJ | TW161DZJ |
|---------------------|-----------|---------------|---------------|---------------|---------------|---------------|--------------------------------|--------------------------------|--------------------------------|--------------------------------|
| Spanning | | 10,8 V | 10,8 V | 10,8 V | 10,8 V | 10,8 V | 10,8 V | 10,8 V | 10,8 V | 10,8 V |
| Bijgeleverde accu's | | 0 | 2 x BL1021B | 2 x BL1041B | 0 | 2 x BL1041B | 0 | 2 x BL1021B | 2 x BL1041B | 0 |
| Toerental | | 0-2600 t.p.m. | 0-2600 t.p.m. | 0-2600 t.p.m. | 0-2600 t.p.m. | 0-2600 t.p.m. | 0-1300 t.p.m. 0-2400 t.p.m. | 0-1300 t.p.m. 0-2400 t.p.m. | 0-1300 t.p.m. 0-2400 t.p.m. | 0-1300 t.p.m. 0-2400 t.p.m. |
| Max. koppel | | 140 Nm | 140 Nm | 140 Nm | 145 Nm | 145 Nm | 165 Nm | 165 Nm | 165 Nm | 165 Nm |
| Snelheden | | 1 | 1 | 1 | 1 | 1 | 2 | 2 | 2 | 2 |
| Auto-stop functie | | - | - | - | - | - | ✓ | ✓ | ✓ | ✓ |
| Opname | | 3/8" | 3/8" | 3/8" | 1/2" | 1/2" | 3/8" | 3/8" | 3/8" | 1/2" |
| BL-motor | | - | - | - | - | - | ✓ | ✓ | ✓ | ✓ |
| Gewicht | | 1,0 kg | 1,0 kg | 1,0 kg | 1,1 kg | 1,1 kg | 1,0 kg | 1,0 kg | 1,0 kg | 1,1 kg |
| Prijs in € | excl. btw | | | | | | | | | |
| | incl. btw | | | | | | | | | |

ACCU RATELMOERSLEUTEL



Geleverd met 1/4" & 3/8" opname

Verwijderbare kop laat toe om 13 mm moeren over de lengte van een M8 draadstang te schroeven.



| | | WR100DZ |
|---------------------|-----------|------------|
| Spanning | | 10,8V |
| Toerental onbelast | | 800 t.p.m. |
| Max. koppel | | 47,5 Nm |
| Bijgeleverde accu's | | - |
| Gewicht | | 1,0 kg |
| Prijs in € | excl. btw | |
| | incl. btw | |

ACCU NIETMACHINE



ST113DSAJ

Met repeteerfunctie en anti-droogschietmechanisme

| | | ST113DZJ | ST113DSAJ | ST113DSMJ |
|---------------------|-----------|-----------|-------------|-------------|
| Spanning | | 10,8V | 10,8V | 10,8V |
| Bijgeleverde accu's | | - | 2 x BL1020B | 2 x BL1040B |
| Rugbreedte niet | | 10 mm | 10 mm | 10 mm |
| Ladercapaciteit | | 150 stuks | 150 stuks | 150 stuks |
| Gewicht | | 1,3 kg | 1,3 kg | 1,5 kg |
| Prijs in € | excl. btw | | | |
| | incl. btw | | | |

ACCU PINPISTOOL



PT354DZJ

| | | PT354DZJ |
|---------------------|-----------|----------|
| Spanning | | 10,8V |
| Bijgeleverde accu's | | - |
| Draadkaliber | | 23 Ga |
| Doorsnede nagel | | 0,6 mm |
| Lengte nagel | | 15-35 mm |
| Gewicht | | 2,0 kg |
| Prijs in € | excl. btw | |
| | incl. btw | |

LUCHTPOMP



MP100DZ

| | | |
|---------------------|-----------|----------------------|
| Spanning | | 10,8V |
| Bijgeleverde accu's | | - |
| Debiet | | 10 l/min (bij 2 bar) |
| Max. druk | | 8,3 bar |
| Gewicht | | 1,2 kg |
| Prijs in € | excl. btw | |
| | incl. btw | |

ACCU SCHUUR-/POLIJSTMACHINE 75 MM



- Geleverd met adapter voor Roloc™ voor schuurtoepassingen en een velcro steunschijf voor het polijsten
- Ideaal voor oppervlaktebehandeling en voor het polijsten van kleine oppervlakken



| | | PV301DZJ | PV301DSAEJ |
|----------------------|-----------|--------------------------|--------------------------|
| Spanning | | 10,8V | 10,8V |
| Bijgeleverde accu's | | - | 2x BL1021B |
| Capaciteit polijsten | | 80 mm | 80 mm |
| Capaciteit schuren | | 50 mm | 50 mm |
| Toerental polijsten | | 0-2800 min ⁻¹ | 0-2800 min ⁻¹ |
| Toerental schuren | | 0-9500 min ⁻¹ | 0-9500 min ⁻¹ |
| Gewicht | | 1,1 kg | 1,1 kg |
| Prijs in € | excl. btw | | |
| | incl. btw | | |

ACCU CIRKELZAAG 85 MM



HS301DSAJ

| | | HS301DSAJ | HS301DSMJ |
|---------------------------|-----------|-------------|-------------|
| Spanning | | 10,8V | 10,8V |
| Bijgeleverde accu's | | 2 x BL1020B | 2 x BL1040B |
| Max. zaagdiepte bij (90°) | | 25,5 mm | 25,5 mm |
| Ø Zaagblad | | 85 mm | 85 mm |
| Gewicht | | 1,6 kg | 1,6 kg |
| Prijs in € | excl. btw | | |
| | incl. btw | | |

ACCU TEGELSNIJDER 85 MM



CC301DSMJ



| | | CC301DZJ | CC301DSMJ |
|---------------------|-----------|----------|-------------|
| Spanning | | 10,8V | 10,8V |
| Bijgeleverde accu's | | - | 2 x BL1040B |
| Zaagdiepte (90°) | | 25,5 mm | 25,5 mm |
| Ø Zaagblad | | 85 mm | 85 mm |
| Gewicht | | 1,9 kg | 1,9 kg |
| Prijs in € | excl. btw | | |
| | incl. btw | | |

ACCU MULTICUTTER

10.8v



| | | CP100DZJ |
|---------------------|-----------|----------|
| Spanning | | 10,8V |
| Bijgeleverde accu's | | - |
| Snijcapaciteit | | 6 mm |
| Gewicht | | 0,72 kg |
| Prijs in € | excl. btw | |
| | incl. btw | |

ACCU GIPSZAAG

10.8v



| | | SD100DZJ |
|---------------------|-----------|----------|
| Spanning | | 10,8V |
| Bijgeleverde accu's | | - |
| Slaglengte | | 6 mm |
| Snijcapaciteit | | 30 mm |
| Gewicht | | 1,5 kg |
| Prijs in € | excl. btw | |
| | incl. btw | |

ACCU DECOUPEERZAGEN

10.8v CXT



JV102DSAJ



JV103DSAJ

| | JV101DSAJ | JV102DZJ | JV102DSAJ | JV102DSMJ | JV103DZJ | JV103DSAJ | JV103DSMJ |
|-----------------------|-------------|---------------|---------------|---------------|---------------|---------------|---------------|
| Spanning | 10,8V | 10,8V | 10,8V | 10,8V | 10,8V | 10,8V | 10,8V |
| Bijgeleverde accu's | 2 x BL1020B | 0 | 2 x BL1020B | 2 x BL1040B | 0 | 2 x BL1020B | 2 x BL1040B |
| Aantal zaagbewegingen | 0-2900 /min | 800-3000 /min | 800-3000 /min | 800-3000 /min | 800-3000 /min | 800-3000 /min | 800-3000 /min |
| Max. capaciteit hout | 65 mm | 90 mm | 90 mm | 90 mm | 90 mm | 90 mm | 90 mm |
| BL-motor | - | ✓ | ✓ | ✓ | ✓ | ✓ | ✓ |
| Gewicht | 1,8 kg | 1,8 kg | 1,8 kg | 1,8 kg | 1,8 kg | 1,8 kg | 1,8 kg |
| Prijs in € | excl. btw | | | | | | |
| | incl. btw | | | | | | |

ACCU RECIPROZAAG

10.8v CXT MAK PAC



JR103DSAJ

| | JR103DSAJ | JR103DSMJ |
|--------------------------------------|-------------|-------------|
| Spanning | 10,8V | 10,8V |
| Bijgeleverde accu's | 2 x BL1020B | 2 x BL1040B |
| Max. zaagcapaciteit hout/stalen buis | 50 mm | 50 mm |
| Gewicht | 1,3 kg | 1,5 kg |
| Prijs in € | excl. btw | |
| | incl. btw | |

ACCU DRAADSTANGKNIPPER

10.8v



Voor gebruiksklaar afkorten zonder vonken!

| | SC103DZJ | |
|---------------------|---------------|--|
| Spanning | 10,8V | |
| Bijgeleverde accu's | - | |
| Afkorten | Mobiel | |
| Snijcapaciteit | M6 - M8 - M10 | |
| Inbegrepen mes | M8, M10 | |
| Gewicht | 2,7 kg | |
| Prijs in € | excl. btw | |
| | incl. btw | |

ACCU KITPISTOOL

CXT 10.8v MAK PAC



CG100DSAEA

CG100DSAEB

CG100DSAEB met aluminium kokerhouder 600 ml (voor worsten of kit in bulkverpakking)

| | CG100DSAEA | CG100DSAEB |
|-----------------------|-------------|-------------|
| Spanning | 10,8V | 10,8V |
| Bijgeleverde accu's | 2 x BL1020B | 2 x BL1020B |
| Max. extrusiekracht | 5000 N | 5000 N |
| Max. extrusiesnelheid | 0-28 mm/s | 0-28 mm/s |
| Prijs in € | excl. btw | |
| | incl. btw | |

ACCU VERWARMD ONDERHEMD

DCX200 - DCX201

- DCX200 serie: met open ronde hals. DCX201 serie: met rechtopstaande kraag en halve ritssluiting
- Voeding middels 14,4V/18V LXT-batterij of compacte BL1055B
- Zeer dunne en elastische stof, waardoor het hemd onder andere kleding gedragen kan worden
- Vier warmtezones en 3 warmtestanden
- Machinewasbaar en geschikt voor droogkast



DEABL1055B
Powerbank



DCX200C

DCX201C

| | | DCX200C | DCX201C |
|-----------------------|-----------------------|---------------------------------|---------|
| Maat | S-M-L-XL-2XL-3XL | | |
| Voeding | 14.4V/18V LXT BL1055B | 14.4V/18V LXT BL1055B | |
| Incl. batterijadapter | TD00000111 | TD00000111 | |
| Model | Open hals | Met kraag en halve ritssluiting | |
| Vermogenniveaus | 2,3W / 4,5W / 9,5W | 2,3W / 4,5W / 9,5W | |
| Verwarmingszones | 4 | 4 | |
| Materiaal | 100% polyester | 100% polyester | |
| Machine wassen/drogen | ✓ | ✓ | |
| Prijs in € | Excl. BTW | | |
| | Incl. BTW | | |

VERWARME JASSEN / BODYWARMERS CXT & LXT



CJ106
DCJ206

CJ106 EN DCJ206:
HIGH VISIBILITY
(CONFORM
ISO 20471/ANSI1107)

CV102 EN DCV202:
ZONDER MOUWEN
(BODYWARMER)



CJ106
DCJ206



CV102
DCV202

| | | CJ105DZ | DCJ205Z | CJ106DZ | DCJ206Z | CV102DZ | DCV202Z |
|------------------------|-------------------|-------------------|-----------------------|-----------------------|--------------------|--------------------|---------|
| Maat | S-M-L-XL-2XL-3XL | | | | | | |
| Spanning | 10,8V | 18V | 10,8V | 18V | 10,8V | 18V | |
| Model | Jas - zwart | Jas - zwart | Jas - High Visibility | Jas - High Visibility | Bodywarmer | Bodywarmer | |
| Vermogen | 2,3W - 7W - 11,5W | 2,3W - 7W - 11,5W | 2,3W - 7W - 11,5W | 2,3W - 7W - 11,5W | 2,3W - 4,5W - 9,5W | 2,3W - 4,5W - 9,5W | |
| Verwarmingszones | 5 | 5 | 5 | 5 | 4 | 4 | |
| Materiaal buitenzijde | Polyester | Polyester | Polyester | Polyester | Polyester Spandex | Polyester Spandex | |
| Materiaal binnenzijde | Fleece | Fleece | Fleece | Fleece | Fleece | Fleece | |
| Water- & windresistent | ✓ | ✓ | ✓ | ✓ | ✓ | ✓ | |
| Machine wassen/drogen | ✓ | ✓ | ✓ | ✓ | ✓ | ✓ | |
| Aantal zakken | 6 | 6 | 6 | 6 | 4 | 4 | |
| Prijs in € | Excl. BTW | | | | | | |
| | Incl. BTW | | | | | | |

ACCU VERWARMD DEKEN



DCB200B

**GESCHIKT VOOR
WASMACHINE &
DROOGKAST**

| | | CB100DB | DCB200B |
|---------------------|--------------------|-----------|---------|
| Bijgeleverde accu's | 0 | | |
| Afmetingen (LxB) | 700 x 1400 mm | | |
| Vermogen | 2,3W - 4,5W - 9,5W | | |
| Materiaal | Polyester | | |
| Spanning | 10,8V | 14,4V/18V | |
| Prijs in € | excl. btw | | |
| | incl. btw | | |

ACCU GEVENTILEERDE VESTEN



Bescherm uzelf tegen de hitte met onze geventileerde vesten op accu!



DFV210Z

Polyester
Waterafstotend
DFV210
Zijdellingse ventilatoren



DFV214A01

**DFV214A01 (S-L) /
DFV214A02 (XL-3XL)**
Zijdellingse ventilatoren



DFJ212Z

Polyester
Waterafstotend
DFJ212
Zijdellingse ventilatoren



DFJ210Z

DFJ211Z

Polyester
Waterafstotend en
vochtdoorlatend
DFJ210/211 (met kap)
Zijdellingse ventilatoren
/



DFJ213Z

Polyester
Stretch
DFJ213
Zijdellingse ventilatoren



DFJ304Z

Katoen
Vochtabsorberend
DFJ304
Zijdellingse ventilatoren



DFJ214Z

Polyester
Waterafstotend en
antistatisch
DFJ214
Zijdellingse ventilatoren



DFJ410Z

DFJ411Z

Polyester met
titanium coating
UV- en IR-reflectorend -
stretch
DFJ410/DFJ411 (met kap)
Zijdellingse ventilatoren
/

| maat (cm) | S | M | L | XL | 2XL | 3XL |
|-----------|----------|----------|-----------|-----------|-----------|-----------|
| Lengte | | | 70 | 71 | 72 | 73 |
| Schouder | | | 48 | 50 | 52 | 54 |
| Mouw* | | | 93 | 95 | 97 | 99 |
| Borst | | | 127 | 132 | 137 | 142 |
| Taille | | | 121 | 126 | 131 | 136 |
| Lengte | | | 69 | 70 | 71 | 72 |
| Schouder | | | 51 | 53 | 55 | 57 |
| Mouw | | | 66 | 67 | 68 | 69 |
| Borst | | | 127 | 132 | 137 | 142 |
| Taille | | | 113 ~ 121 | 118 ~ 126 | 123 ~ 131 | 128 ~ 136 |
| Lengte | | | 72 | 73 | 74 | 75 |
| Schouder | | | 51 | 53 | 55 | 57 |
| Mouw | | | 66 | 67 | 68 | 69 |
| Borst | | | 127 | 132 | 137 | 142 |
| Taille | | | 113 ~ 121 | 118 ~ 126 | 123 ~ 131 | 128 ~ 136 |
| Lengte | 64 | 66 | 68 | 70 | 72 | 74 |
| Schouder | 51.55 | 4 | 56.55 | 9 | 61.56 | 4 |
| Mouw | 54 | 56 | 58 | 60 | 62 | 64 |
| Borst | 116 | 121 | 126 | 131 | 136 | 141 |
| Taille | 77 ~ 108 | 82 ~ 113 | 87 ~ 113 | 92 ~ 133 | 97 ~ 113 | 102 ~ 133 |
| Lengte | | | 71 | 72 | 73 | 74 |
| Schouder | | | 47 | 49 | 51 | 53 |
| Borst | | | 123 | 128 | 133 | 138 |
| Taille | | | 117 | 122 | 127 | 132 |

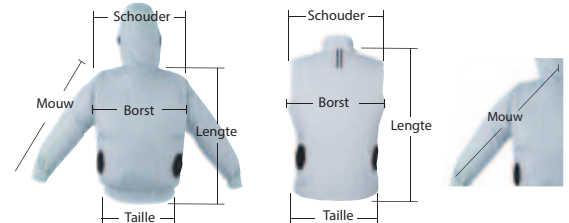

198634-2
Accu-adaptor LXT-batterijen

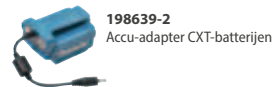

198639-2
Accu-adaptor CXT-batterijen

ACCU VENTILATOREN

CF003G



Ideaal voor het ventileren van grotere ruimten, zoals magazijnen of werkplaatsen.



DCF102Z

Voeding middels XGT/LXT accu's netstroom



Variabele toerentalregeling



DCF301Z



CF001GZ



CF002GZ



CF003GZ

| | DCF102Z | DCF203Z | DCF301Z | CF001GZ | CF002GZ | CF003GZ |
|------------------|---------------|---------------|---------------|------------------------|------------------------|-----------------------------------|
| Spanning | 18 V / 14,4 V | 18 V / 14,4 V | 18 V / 14,4 V | 36 V (40Vmax) XGT / AC | 36 V (40Vmax) XGT / AC | 36 V (40Vmax) XGT / 18 V LXT / AC |
| AC adapter | Optioneel | Optioneel | inclusief | inclusief | inclusief | inclusief |
| Diameter | 180 mm | 235 mm | 300 mm | 235 mm | 330 mm | 450 mm |
| Auto zwenken L/R | ✓ | ✓ | ✓ | ✓ | ✓ | ✓ |
| Timer | ✓ | ✓ | ✓ | ✓ | ✓ | ✓ |
| Gewicht | 1,3 kg | 2,5 kg | 4,3 kg | 2,0 - 3,0 kg | 4,5 - 5,1 kg | 7,9 - 10,5 kg |
| Prijs in € | excl. btw | | | | | |
| | incl. btw | | | | | |

ACCU KOFFIEZETAPPARAAT



Ideaal voor op de bouw- en werkplaats.
Werkt zowel met koffiepads als met gemalen koffie.
Met één accu (LXT 5,0 Ah) maak je 3 koppen koffie van 160 ml.



| | | DCM501Z |
|---------------------------------------|-----------|-----------------|
| Spanning | | 10,8V/14,4V/18V |
| Bijgeleverde accu's | | - |
| Inhoud waterreservoir | | 240 ml |
| Bereidingstijd met 18 V accu (150 ml) | | 5 min. |
| Gewicht | | 1,9 - 2,2 kg |
| Prijs in € | excl. btw | |
| | incl. btw | |

ACCU WATERKOKER



- Dubbellaagse roestvrijstalen wand
- Met voedingsstandaard en groot handvat
- Uitgerust met morsbeveiliging



DKT360Z



| | | DKT360Z | KT001GZ |
|--------------------------|-----------|----------------------|----------------------|
| Spanning | | 2x18V | 36 V (40Vmax) |
| Inhoud | | 0,8 l | 0,8 l |
| Kooktijd voor 0,8 l | | ca. 8 min | ca. 8 min |
| Verwarmcapaciteit 100 °C | | 1,2 l met 2 x BL1850 | 1,2 l met 2 x BL4025 |
| Gewicht | | 2,7 - 3,4 kg | 2,8 - 5,9 kg |
| Prijs in € | excl. btw | | |
| | incl. btw | | |

MICROGOLFOVEN



- Ideaal om voeding op te warmen op plaatsen waar geen netstroom beschikbaar is.
- Werkt met één 40Vmax accu of twee in parallel.
- Compact, gemakkelijk te transporteren.
- Vermogenniveaus: 350W en 500W
- De verwarmingstijd kan ingesteld worden van 10 seconden tot 20 minuten.
- Met 2x BL4040 en op volle vermogen kunnen ongeveer 5 maaltijden of 8 koppen van 200 ml opgewarmd worden.

| MW001GZ | |
|-----------------------|--------------------------------|
| Spanning | 36V (40Vmax) |
| Bijgeleverde accu's | - |
| Bijgeleverde lader | - |
| Inhoud | 8 l |
| Binnenafmetingen | 255 x 241 x 120 mm |
| Uitgangsvermogen | 350 W / 500 W |
| Autonomie (2x BL4040) | 350 W: 21 min 500 W: 15 min |
| Gewicht | 9,5 - 12,7 kg |
| Prijs in € | excl. btw |
| | incl. btw |

VRIES-/ KOELBOX MET VERWARMFUNCTIE



CW004G

- Capaciteit van 29 l
- Uiterst efficiënt en groot koelvermogen door het gebruik van een compressor
- De ruimte kan onderverdeeld worden in twee vakken met elk een eigen temperatuurinstelling, bijvoorbeeld een koel- en vriesvak. Standaard geleverd met binnenbakje en binnenmand
- Het deksel kan aan beide zijden geopend worden of volledig verwijderd voor het gemakkelijk reinigen
- Met beugel om te rollen op de wielen en ook voorzien van inklapbare handvaten zijdelings om gemakkelijk te dragen



CW003GZ



CW004GZ



CW004GZ



CW002GZ01



CW004GZ

| | CW003GZ | CW001GZ01 | CW004GZ | CW002GZ01 |
|---------------|---|---|--|---|
| Voeding | 36V (40Vmax) XGT / 18V LXT / AC / 12V DC - 24V DC | 36V (40Vmax) XGT / 18V LXT / AC / 12V DC - 24V DC | 36V (40Vmax) XGT / 18V LXT / AC / 12V DC - 24V DC | 36V (40Vmax) XGT / 18V LXT / AC / 12V DC - 24V DC |
| Inhoud | 7 l | 20 l | 29 l | 50 l |
| Koelen | -18 / -15 / -10 / -5 / 0 / 5 / 10 °C | -18 / -15 / -10 / -5 / 0 / 5 / 10 °C | -18 / -15 / -10 / -5 / 0 / 5 / 10 °C | -18 / -15 / -10 / -5 / 0 / 5 / 10 °C |
| Verwarmen | 30 / 35 / 40 / 45 / 50 / 55 / 60 °C | 30 / 35 / 40 / 45 / 50 / 55 / 60 °C | 30 / 35 / 40 / 45 / 50 / 55 / 60 °C | 30 / 35 / 40 / 45 / 50 / 55 / 60 °C |
| Autonomie ca. | -18 °C: 5,5 uur, 5 °C: 13,5 uur, 60° C: 5,5 uur (1x BL4040) | -18 °C: 8 uur, 5 °C: 22,5 uur, 60° C: 7 uur (2x BL4040) | -18 °C: 10,0 h, 5 °C: 24,0 h (at 30 °C) 60 °C: 9,0 h (at 0° C) Dual room mode (left -18 °C, right 5°C): 9,0 h | -18 °C: 8 uur, 5 °C: 19,5 uur, 60° C: 4,5 uur (2x BL4040) |
| Afmetingen | 456 x 245 x 308 mm | 663 x 341 x 372 mm | 676 x 345 x 471 mm | 867 x 465 x 476 mm |
| Gewicht | 7,9 - 9,4 kg | 13,8 - 17,3 kg | 17,5 - 20,9 kg | 25,6 - 29,0 kg |
| Prijs in € | excl. btw | | | |
| | incl. btw | | | |

MINILUCHTPOMP



Bedieningspaneel
De DMP181 is uitgerust met een groot display met achtergrondverlichting.



DMP181Z



DMP180Z



MP001GZ

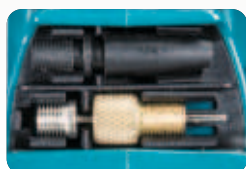

Standaard met verschillende ventieladapters

| | DMP180Z | DMP181Z | MP001GZ |
|-------------------------|-----------|---------------|---------------|
| Spanning | 18 V | 18 V | 36 V (40Vmax) |
| Bijgeleverde accu/lader | - | - | 0 |
| Debiet | 10 l/min | 11 – 22 l/min | 12 – 24 l/min |
| Max. druk | 8,3 bar | 11,1 bar | 11,1 bar |
| Gewicht | 1,5 kg | 2,5 – 2,8 kg | 2,9 – 3,5 kg |
| Prijs in € | excl. btw | | |
| | incl. btw | | |

BLAAS- EN ZUIGMACHINE



DAS180Z

- Traploos regelbare snelheid met vario-schakelaar en voorkeuze van 4 maximumsnelheden.
- Verschillende mondstukken beschikbaar voor uiteenlopende toepassingen. Standaard worden 5 mondstukken meegeleverd.
- Kan ook gebruikt worden om lucht weg te zuigen via een speciaal opzetstuk (optioneel).
- Ideaal voor het reinigen van gereedschap en onderdelen. Kan ook gebruikt worden om bijvoorbeeld speelgoed voor op het water op te blazen of snel af te laten.



| | DAS180Z | AS001GZ |
|-------------------|--------------|---------------|
| Spanning | 18V | 36 V (40Vmax) |
| Bijgeleverde accu | - | - |
| Max. debiet | 1,1 m³/min | 0 -1,3 m³/min |
| Blaaskracht | 2,8 N | 2,8 N |
| Max. onderdruk | 93 mbar | 103 mbar |
| Gewicht | 1,2 - 1,7 kg | 1,5 – 2,3 kg |
| Prijs in € | excl. btw | |
| | incl. btw | |

● Standaard meegeleverde accessoires

● Optioneel verkrijgbare accessoires



191X11-1
Blaasmond
3 mm



191X13-7
Blaasmond
7 mm



191X15-3
Blaasmond
13 mm



191X17-9
Blaasmond
voor opblazen



191X19-5
Brede
blaasmond



191X21-8



191X23-4



191X23-4



191X27-6

191X29-2



Prijs excl. btw



191X78-9

Prijs incl. btw

| Referentie | Omschrijving |
|------------|---|
| 191X21-8 | Flexibele blaasmond |
| 191X23-4 | Verlengstuk |
| 191X25-0 | Opzetstuk 20/30mm (voor grotere volumes) |
| 191X27-6 | Opzetstuk zuigmond 65 mm (voor leeglopen) |
| 191X29-2 | Fijnstoffilter |
| 191X78-9 | Kierblaasmond 8 mm (set) |

ACCU BLUETOOTH-SPEAKERS



LXT XGT

40V max

MR014GZ
BLUETOOTH-SPEAKER



Smartphone stand



Microfoon-aansluiting met ingebouwde versterker

Bluetooth



Equalizer

DMR203
BLUETOOTH-SPEAKER MET KOPPELFUNCTIE

Koppelbaar per 2:
True Wireless Stereo tot 10:
simultaan luisteren



MR014GZ

- Hoge geluidskwaliteit met diepe bastonen dankzij nieuwe decoders, een grote woofer en twee passieve radiators
- Microfoonaansluiting met ingebouwde versterker
- Bluetooth bereik tot 30 m
- Twee toestellen kunnen gecombineerd worden voor stereogeluid, en tot 10 toestellen om overall muziek te kunnen beluisteren in grotere complexen.
- Met equalizer, groot kleurdisplay en actieve led decoratie rondom de speaker.
- Uitstekende IP65 bescherming tegen water en stof

ACCU RADIO'S



DAB+
MR003GZ
WERFRADIO
XGT / LXT



DAB+
Bluetooth
MR004GZ
WERFRADIO
XGT / LXT



DAB+
Bluetooth
MR007GZ
WERFRADIO
XGT / LXT



DAB+
Bluetooth
DMR301
WERFRADIO
CXT / LXT



DMR301 met laadfunctie voor LXT / CXT accu's



DAB+
Bluetooth
DMR056
RADIO MET LANTAARN LXT



DAB+
Bluetooth
MR009GZ
RADIO MET LANTAARN XGT

HANDGEREEDSCHAPSETS

Onze favoriet!
E-10883: 221-delige gereedschapskoffer voor kleine herstellingen



Scan mij voor meer info!



E-10883
GEREEDSCHAPSET
221-DELIG

MAKPAC OPBERGSYSTEEM



- Inclusief 5 types van bakjes : 150x150 mm (1), 150x100 mm (1), 100x100 mm (2), 100x50 mm (3) en 50x50 mm (6)
- Bijkomende inzetbakjes zijn apart te verkrijgen
- Flexibel indeelbaar
- Koppelbaar met Makita Makpacs, Makstors, Makpac trolley TR00000001 en Makpac transportkar P-83886

191X80-2
395 x 295 x 110 mm
2.3 kg

MAKSTORS



P-84311 Makstor nr. 3 met 4 lades.



P-84333 Makstor nr. 3 met 6 lades



P-84327 Makstor nr. 3 met 12 lades



P-84349 Makstor nr. 4 met 5 lades

Koppelbaar met alle Makita Makpacs, alsook met Makpac IV koelbox 198253-4, de Makpac trolley TR00000001 en de Makpac transportkar P-83886

De lades van de Makstor zijn flexibel indeelbaar. Standaard worden er bij deze Makstor 8 verdelers / tussenschotten geleverd. De lades zijn voorzien van een vergrendelingsstelsel en kunnen gelabeld worden

IDEAAL OM LOS MATERIAAL IN TE BEWAREN ZOALS BOREN EN BITSEN

| Omschrijving | Ref. | Indeling | Afmetingen | Prijs excl. btw | Prijs incl. btw |
|------------------|---------|---|--------------------------------|-----------------|-----------------|
| Makstor nr. 3-4 | P-84311 | 4 lades (1 groot / 2 klein / 1 middelgrote) | 395 (L) x 295 (B) x 210 (H) mm | | |
| Makstor nr. 3-12 | P-84327 | 12 kleine lades | 395 (L) x 295 (B) x 210 (H) mm | | |
| Makstor nr. 3-6 | P-84333 | 6 middelgrote lades | 396 (L) x 295 (B) x 210 (H) mm | | |
| Makstor nr. 4-5 | P-84349 | 5 lades (2 groot / 2 klein / 1 middelgrote) | 395 (L) x 295 (B) x 320 (H) mm | | |

BOOR- EN SCHROEFBITSET IN MAKPAC



E-24913
BOOR- EN SCHROEFBITSET
IN MAKPAC 70-DELIG

MAKPAC GEREEDSCHAPSKIST



P-83836



P-83842

5-delige opbergset



P-84137

| Ref. | Omschrijving | Prijs excl. btw | Prijs incl. btw |
|---------|--------------------------------|-----------------|-----------------|
| P-83836 | hoogte: 14 cm | | |
| P-83842 | hoogte: 25 cm | | |
| P-84137 | 396 (L) x 295 (B) x 210 (H) mm | | |

MAKPAC COOLBOX



198253-4
MAKPAC
COOLBOX (18L)



Stapelbaar



Met draaglint

MAKPAC TRANSPORTKAR



P-83886
MAKPAC TRANSPORTKAR



LAMPEN

ZAKLAMPEN CXT



| | DEAML103 | DEAML104 | DEAML105 | DEAML106 |
|--|-----------------|--|--------------------------------------|------------------|
| Spanning | 10,8 V (12Vmax) | 10,8 V (12Vmax) | 10,8 V (12Vmax) | 10,8 V (12Vmax) |
| Max. lichtstroom | 100 lm | 710 lm | 190 lm | 190 lm |
| Verlichtingssterkte op 1 m | 50 lx | 340 lx (0,5 m, lantaarn) | 5500 lx | 170 - 4500 lx |
| Werkingsduur bij max intensiteit, accu BL1041B | 28 u. | 5,5 u. | 14 u. | 12 u. |
| Specifieke functionaliteiten | Uiterst compact | Lantaarn (360°) en zaklamp (gericht) USB uitgang | Reflector in 12 posities verstelbaar | Zoom functie |
| Afmetingen | 77 x 54 x 28 mm | 414 x 66 x 132 mm | 249 x 66 x 93 mm | 271 x 66 x 93 mm |
| Gewicht | 0,27 - 0,43 kg | 0,61 - 0,78 kg | 0,53 - 0,7 kg | 0,61 - 0,78 |
| Prijs in € | excl. btw | | | |
| | incl. btw | | | |

DEADML105 - DEADML815 - DEAML001G

Reflector 170° kantelbaar in 12 stappen

170°



DEADML104 - DEBDML806 - DEBDML807 - DEAML002G

3 modi: 360° zijdelings licht, 180° zijdelings licht en gericht licht (bovenaan).
USB uitgang Type A: 5V 2,4 A (behalve DEBDML806)

3 MODI

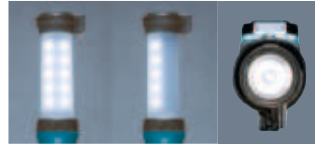

USB uitgang



BEADML810

Ontwerp met laag zwaartepunt zodat de lamp niet kan omvallen



WERFLAMPEN LXT



| | DEADML805 | BEADML810 | BEADML813 | BEADML814 |
|--|-------------------------|-------------------------|--------------------------|--|
| Spanning | 18 V / 14,4 V / AC | 18 V / 14,4 V / AC | 18 V / 14,4 V | 18 V / 14,4 V |
| Max. lichtstroom | 750 lm | 5500 lm | 3000 lm | 3000 lm |
| Verlichtingssterkte op 1 m | 300 lx | 550 lx | 1250 lx | 1250 lx |
| Verlichtingssterkte op 3 m | - | 70 lx | 130 lx | 130 lx |
| Verlichtingssterkte op 5 m | - | 25 lx | 50 lx | 50 lx |
| Verlichtingscapaciteit naar voor/zijdelings | - | 360°, ± 4 m | 4,5 m/5,3 m | 4,7 m/5,6 m |
| Werkingsduur bij max intensiteit, accu BL1850B | 8,5 u. | 3,5 u. | 3 u. (2xBL1850B) | 3 u. (2xBL1850B) |
| Specifieke functionaliteiten | DC/AC 2 hieldersniveaus | DC/AC 3 hieldersniveaus | Geïntegreerd statief | Geïntegreerd statief Met 3 afzonderlijk richtbare lichtunits |
| Afmetingen | 214 x 261 x 328 mm | 420 x 420 x 787 mm | 573 x 658 x 1250-2240 mm | 573 x 658 x 1250-2240 mm |
| Gewicht | 2,3 - 2,7 kg | 13,9 - 15,3 kg | 7,2 - 7,9 kg | 7,4 - 8,1 kg |
| Prijs in € | excl. btw | | | |
| | incl. btw | | | |

BEADML813- BEADML814

Uitschuifbaar van 1250 mm tot 2240 mm
Gemakkelijk opvouwbaar voor transport

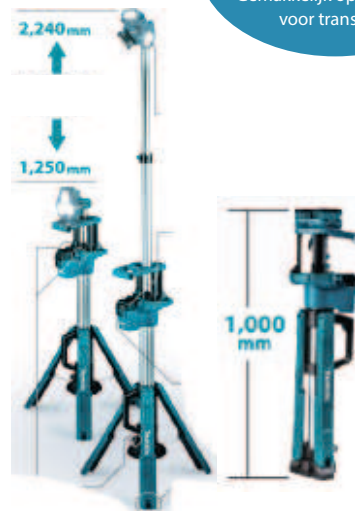

EUAML010GZ

Voeding middels XGT accu's, LXT accu's of netstroom
• Tot 4 accu's kunnen tegelijkertijd gemonteerd worden
• Kan tot 80° kantelen zonder om te vallen
• Werktijd bij maximum intensiteit: 8,5 uur (2x BL4050F)
• Beschermingsklasse IP54 (bij werking op accu)

ZAKLAMPEN LXT



| | DEADML803 | DEBDML186 | DEBDML800 | DEBDML815 | DEBDML808 | DEADML816 | DECDML807 | DEADML817 | DEBDML812 | EUADML818 |
|--|------------------------------------|------------------|------------------|-------------------------------------|------------------|-----------------------------------|--|--------------------------------|---------------------------------|---------------------------|
| Spanning | 18V / 14,4V | 18V / 14,4V | 18V / 14,4V | 18V / 14,4V | 18V / 14,4V | 18V / 14,4V | 18V / 14,4V | 18V / 14,4V | 18V / 14,4V | 18 V |
| Max. lichtstroom | 170 lm | - | 100 lm | 160 lm | 190 lm | 500 lm | 710 lm (lantaarn) | 300 lm | 1000 lm (flood) | 1700 lm |
| Verlichtingssterkte op 1 m | 270 lx (0,5 m) | 500 lx | 2000 lx | 3000 lx | 170 - 4500 lx | 800 lx (1m) | 340 lx (0,5 m, lantaarn) | 240 lx (0,5 m) | 520 lx (0,5 m flood) | 600 lx |
| Werkingsduur bij max intensiteit, accu BL1850B | 26 u. | 83 u. | 33 u. | 45 u. | 26 u. | 75 h | 23 u. | 23 u. | 6,5 u (flood) | 4 u |
| Specifieke functionaliteiten | Batterijhouder met riembevestiging | Met handriem | Hoofdlamp | Reflector in 12 posities kantelbaar | Zoom functie | Reflector draaibaar en kantelbaar | Lantaarn (360°) en zaklamp (gericht) USB uitgang | 3 verlichtingsmodi USB uitgang | Modi: spot, flood, spot + flood | 3 helderheidsinstellingen |
| Afmetingen | 133 x 81 x 72 mm | 151 x 81 x 61 mm | 133 x 76 x 88 mm | 256 x 79 x 99 mm | 280 x 79 x 10 mm | 383 x 79 x 110 mm | 414 x 79 x 155 mm | 107 x 77 x 50mm | 313 x 119 x 115 mm | 972 x 80 x 134 cm |
| Gewicht | 0,56 - 0,92 kg | 0,51 - 0,83 kg | 0,58 - 0,64 kg | 0,26 - 0,93 kg | 0,73 - 1,09 kg | 0,70 - 1,1 kg | 0,72 - 1,1 kg | 0,51 - 0,88 kg | 1,2 - 1,6 kg | 1,7 kg |
| Prijs in € | excl. btw | | | | | | | | | |
| | incl. btw | | | | | | | | | |

DEADML816 - DEAML006G
De lichtkop is draaibaar, kantelbaar en opvouwbaar



Lichtstroom (Lumen, lm): de hoeveelheid uitgestraald licht per tijdseenheid. Het is een maat voor het vermogen van de lamp.

Verlichtingssterkte (Lux, lx): de lichtstroom per oppervlakte of dus de mate waarin een vlak verlicht wordt. De verlichtingssterkte is afhankelijk van de afstand tot de lichtbron.

Verlichtingscapaciteit: de zone waar de verlichtingssterkte minstens 70 lx is (de verlichtingssterkte die minimaal nodig is om veilig te kunnen werken).

EUADML818 - EUML012G

- LED-lichtbalk met brede verlichting
- Versie EUADML818 voor gebruik met 14,4/18V LXT accu's, versie EUML012G voor XGT
- 3 helderheidsinstellingen: 400 / 800 / 1700 lumen
- Ideaal voor bijvoorbeeld autogarages en pechverhelpingsdiensten. Met de meegeleverde telescopische haak kan het apparaat aan de motorkap of achterdeur van een voertuig bevestigd worden.
- De LED-lichtbalk bestaat uit twee delen en kan in tweeën worden gevouwen.
- De bovenste en onderste helft van de lichtbalk kunnen afzonderlijk ingeschakeld worden
- De verlichtingshoek kan gekozen worden door de lichtbalk te draaien (7 standen)



WERFLAMPEN LXT & XGT



| | DEAML003G | DEAML005G | DEAML009G | EUAML010G | EUAML012G |
|---|---------------------------|---------------------------|---------------------------|-----------------------------|---------------------------|
| Spanning | 36V (40Vmax) /18 V | 36 V (40Vmax) /18 V | 36 V (40Vmax) /18 V | 40Vmax /18 V / 14,4 V / AC | 36 V (40Vmax) |
| Max. lichtstroom | 1100 lm | 3600 lm | 10000 lm | 5500 lm | 1700 lm |
| Verlichtingssterkte op 1 m | 500 lx | 2100 lx | 4300 lx | 550 lx | 600 lx |
| Verlichtingssterkte op 3 m | - | 230 lx | 500 lx | 70 lx | - |
| Verlichtingssterkte op 5 m | - | 90 lx | 110 lx | 25 lx | - |
| Verlichtingscapaciteit naar voor/zijdelings | 2,8 m/3,0 m | 6,0 m/6,4 m | 9,7 m/11,4 m | 360°, ± 4 m | 3,0 m, 3,3 m |
| Werkingsduur bij max intensiteit, accu BL4040 | 10 u. | 3,5 u. | 2,4 u. | 6,5 u (2x BL4040) | 7 u |
| Specifieke functionaliteiten | 2 helderheidsinstellingen | 3 helderheidsinstellingen | 3 helderheidsinstellingen | DC/AC 3 helderheidsniveau's | 3 helderheidsinstellingen |
| Afmetingen | 249 x 298 x 280 mm | 248 x 309 x 296 mm | 248 x 386 x 305 mm | 490 x 490 x 814 mm | 972 x 85 x 138 mm |
| Gewicht | 3,7 - 4,7 kg | 4,6 - 6,5 kg | 6,4 - 9,9 kg | 14,4 - 19,2 kg | 2,0 kg |
| Prijs in € | excl. btw | | | | |
| | incl. btw | | | | |

ACCESSOIRES



Statief voor DML805
GM00002283



Spanvijs voor DML805
GM00001396



Statief voor DML809 / DML811 / ML003G-
GM00002073

STEELOFZUIGERS MET GEÏNTEGREERDE ACCU



| | CL114FDWIX | CL117FDX2 | CL117FDX5 | CL117FDX8 |
|---------------------|--------------|--------------|--------------|--------------|
| Spanning | 10,8 V | 10,8 V | 10,8 V | 10,8 V |
| Bijgeleverde accu's | Geïntegreerd | Geïntegreerd | Geïntegreerd | Geïntegreerd |
| Max. debiet | 1,4 m³/min | 1,0 m³/min | 1,0 m³/min | 1,0 m³/min |
| Max. onderdruk | 34 mbar | 50 mbar | 50 mbar | 50 mbar |
| Stofopvang | Stofzak | Capsule | Capsule | Capsule |
| Klikvergrendeling | ✓ | ✓ | ✓ | ✓ |
| Kleur | Beige | Turquoise | Groen | Purper |
| Promo | - | - | - | - |
| Gewicht | 0,94 kg | 1,0 kg | 1,0 kg | 1,0 kg |
| Prijs in € | excl. btw | | | |
| | incl. btw | | | |

CYCLONMODULE

- ✓ Het grove stof wordt van het fijne stof gescheiden.
- ✓ Stofzak of capsule voor het fijn stof tot 80 % minder vaak ledigen!
- ✓ Het reservoir van de module is zeer gemakkelijk te ledigen en uit te wassen.

Gemakkelijk te ledigen

Extra opvangcapaciteit
400 ml



| Ref. | Kleur | Prijs excl. btw | Prijs incl. btw |
|---------------------------------------|-------|-----------------|-----------------|
| Cyclonmodule met klikvergrendeling | | | |
| 191D71-3 | wit | | |
| 191D73-9 | zwart | | |
| Cyclonmodule zonder klikvergrendeling | | | |
| 199491-1 | wit | | |
| 191d75-5 | zwart | | |

OPTIONELE ACCESSOIRES



Muurbevestiging 199971-7



Vloerzuigmond tapijt 198527-3



Kierzuigmond lang 198990-0



Ronde borstel 198553-2



Steeleofzuigerstandaard 1911L1-0

STEELOFZUIGERS CXT/ LXT



DCL284, DCL285 & DCL286:

- Nieuwe brushless motor levert hoge zuigkracht.
- Laag geluidsniveau door vernieuwd ontwerp van luchtuitlaat.
- De DCL286 heeft een ingebouwde cyclonmodule: deze vangt grove stofdeeltjes op waardoor de optimale zuigkracht langer behouden blijft.



| | CL102DW | CL107FDZW | DCL180ZB | DCL182Z | DCL284FZB | DCL284FRFB | DCL285FZ | DCL285FRF | DCL286FZW | DCL286FRFW |
|---------------------|------------|--------------|------------|------------|-----------------|-----------------|--------------|--------------|--------------|--------------|
| Spanning | 10,8V | 10,8 V (CXT) | 18 V (LXT) | 18 V (LXT) | 18 V (LXT) | 18 V (LXT) | 18 V (LXT) | 18 V (LXT) | 18 V (LXT) | 18 V (LXT) |
| Bijgeleverde accu's | 1 x BL1013 | - | - | - | - | 1x BL1830 | - | 1x BL1830 | - | 1x BL1830 |
| Max. debiet | 0,9 m³/min | 1,4 m³/min | 1,4 m³/min | 1,4 m³/min | 1,2 m³/min | 1,2 m³/min | 1,2 m³/min | 1,2 m³/min | 1,0 m³/min | 1,0 m³/min |
| Max. onderdruk | 23 mbar | 50 mbar | 42 mbar | 54 mbar | 180 mbar | 180 mbar | 180 mbar | 180 mbar | 180 mbar | 180 mbar |
| Stofopvang | Stofzak | Stofzak | Capsule | Stofzak | Capsule | Capsule | Stofzak | Stofzak | Cyclon | Cyclon |
| Klikvergrendeling | - | - | - | - | ✓ | ✓ | ✓ | ✓ | ✓ | ✓ |
| BL motor | - | - | - | - | ✓ | ✓ | ✓ | ✓ | ✓ | ✓ |
| Kleur | Wit | wit | Zwart | Blauw | zwart/turquoise | zwart/turquoise | Blauw | Blauw | Wit | Wit |
| Gewicht | 1,1 kg | 1.1 - 1.3 kg | 1,2 kg | 1,3 kg | 1.3 - 1.6 kg | 1.3 - 1.6 kg | 1.4 - 1.7 kg | 1.4 - 1.7 kg | 1.6 - 1.9 kg | 1.6 - 1.9 kg |
| Prijs in € | excl. btw | | | | | | | | | |
| | incl. btw | | | | | | | | | |

XGT STEELSTOFZUIGERS



NIEUW

CL004G

- Hoog reinigingsvermogen op tapijten dankzij geïntegreerde roterende borstel.
- Vernieuwd compact ontwerp met de cycloonunit onderaan de steel
- Laag geluidsniveau

| | CL001GZ05 | CL001GD208 | CL002GZ03 | CL002GD205 | CL002GZ07 | CL002GD212 | CL003GZ04 | CL004GZ |
|---------------------|---------------|---------------|---------------|---------------|---------------|---------------|-----------------|-----------------|
| Spanning | 36 V (40Vmax) | 36 V (40Vmax) | 36 V (40Vmax) | 36 V (40Vmax) | 36 V (40Vmax) | 36 V (40Vmax) | 36 V (40Vmax) | 36 V (40Vmax) |
| Bijgeleverde accu's | - | 2x BL4025 | - | 2x BL4025 | - | 2x BL4025 | - | - |
| Bijgeleverde lader | - | DC40RA | - | DC40RA | - | DC40RA | - | - |
| Max. debiet | 1,2 m³/min | 1,2 m³/min | 1,2 m³/min | 1,2 m³/min | 1,2 m³/min | 1,2 m³/min | 1,0 m³/min | 1,0 m³/min |
| Max. onderdruk | 210 mbar | 210 mbar | 210 mbar | 210 mbar | 210 mbar | 210 mbar | 200 mbar | 200 mbar |
| Stofopvang | Capsule | Capsule | Stofzak | Stofzak | Stofzak | Stofzak | Cycloon-capsule | Cycloon-capsule |
| Klikvergrendeling | ✓ | ✓ | ✓ | ✓ | ✓ | ✓ | ✓ | ✓ |
| Kleur | Turquoise | Turquoise | Zwart | Zwart | Wit | Wit | Zwart | Wit |
| Gewicht | 1,7 - 2,3 kg | 1,7 - 2,3 kg | 1,7 - 2,3 kg | 1,7 - 2,3 kg | 1,7 - 2,3 kg | 1,7 - 2,3 kg | 1,9 - 2,5 kg | 2,2 - 2,8 kg |
| Prijs in € | excl. btw | | | | | | | |
| | incl. btw | | | | | | | |

CLEANING COMBOPACK



CLX245SAX1

| | |
|---------------------|-------------|
| Spanning | 10,8 V |
| Meegeleverde accu's | 1 x BL1021B |
| Lader | DC10SB |
| Steelstofzuiger | CL108FDZW |
| Blaas-/ zuigmachine | UB100DZ |
| Gereedschapstas | ✓ |
| Prijs in € | excl. btw |
| | incl. btw |

ACCU CYCLOONSTOFZUIGER



DCL501Z

DCL501Z

| | |
|---------------------|------------|
| Spanning | 18 V |
| Bijgeleverde accu's | 0 |
| Max. debiet | 1,3 m³/min |
| Max. onderdruk | 66 mbar |
| Gewicht | 3,1 kg |
| Prijs in € | excl. btw |
| | incl. btw |

Technologie

Auto-start wireless system



Geniet van stofvrij werken met AWS!

Bij het starten van de accumachine wordt de stofafzuiging automatisch geactiveerd d.m.v. een Bluetooth verbinding. Wanneer het verbonden toestel uitgeschakeld wordt, gaat de stofzuiger weer in stand-by modus. Sommige accustofzuigers zoals VC009 of DVC867 hebben AWS reeds standaard ingebouwd en kunnen dus rechtstreeks communiceren met AWS-compatibele gereedschappen.

Via de optionele adapter WUT02U kunnen nu ook stofzuigers op netstroom draadloos aangestuurd worden, ongeacht het merk. De enige vereiste is dat de stofzuiger met een startautomatiek uitgerust is.

AWS-compatibele stofzuiger



DVC867L



Stofzuiger met startautomatiek



Adapter WUT02U 199773-1



Bluetooth unit 198900-7

ACCU BLAAS- EN ZUIGMACHINE



UB002G

- Hoger debiet dankzij een verbeterde luchtinlaat.
- Standaard geleverd met korte en lange blaaspip.

UB101DZ & DUB186:

uitvoering met lange pijp, ideaal om laag bij de grond te blazen.

prijzen geldig t.e.m. 31/12/2024



UB002GZ01

DUB185Z

DUB186Z

NIEUW

| | UB100DZ | UB101DZ | DUB185Z | DUB186Z | UB002GZ01 |
|--------------------|-------------|--------------|--------------|--------------|--------------|
| Spanning | 10,8V | 10,8V | 18V | 18V | 36V (40Vmax) |
| Blaaskracht | 1,8 N | 1,6 N | 3,1 N | 2,5 N | 3,2 N |
| Max. luchtsnelheid | 75 m/s | 65 m/s | 98 m/s | 68 m/s | 99 m/s |
| Max. debiet | 2,6 m³/min | 2,6 m³/min | 3,2 m³/min | 3,2 m³/min | 3,6 m³/min |
| Gewicht | 1,4 - 1,9kg | 1,4 - 1,9 kg | 1,6 - 2,1 kg | 1,6 - 2,1 kg | 2,0 - 3,5 kg |
| Prijs in € | excl. btw | | | | |
| | incl. btw | | | | |

BLAAS- EN ZUIGMACHINE 230V



Multifunctionele schakelaar met snelheidsinstelling

UB1103

| | |
|--------------------|------------|
| Vermogen | 600 W |
| Max. luchtsnelheid | 91 m/s |
| Max. debiet | 4,1 m³/min |
| Gewicht | 2,0 kg |
| Prijs in € | excl. btw |
| | incl. btw |

ACCU RUGGEDRAGEN STOFZUIGERS



DVC660

DVC665



DVC660
Uitvoering speciaal voor schoonmaak, geleverd met diverse accessoires.

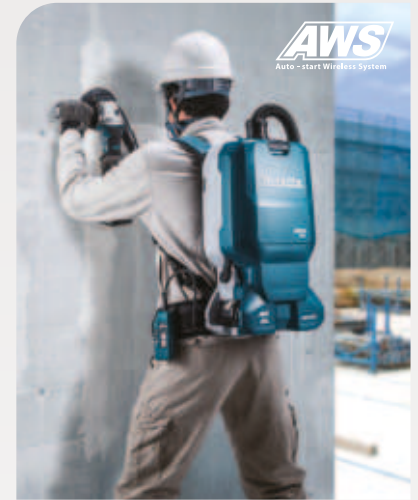

DVC665
Uitvoering voor stofafzuiging in combinatie met machines.



HEPA-filter

Als hoofdfilter wordt een HEPA-filter gebruikt die zeer fijne stofdeeltjes effectief tegenhoudt. De filter kan tot 99,97 % van de deeltjes tussen 0,3 en 1 µm filteren, waardoor de uitgeblazen lucht zeer zuiver is.



Filterreiniging

Door de trillingen van het stappen of het manueel indrukken van de hendel wordt het fijn stof van de papierfilter geschud. Daardoor blijft de zuigkracht langer optimaal bij het opzuigen van fijn stof.



DVC265ZXU DVC261ZX11 DVC660Z DVC665ZX1U

| | | | | |
|--------------------|------------------------|----------------|----------------|------------------------|
| Spanning | 2 x 18 V | 2 x 18 V | 2 x 18 V | 2 x 18 V |
| Max. debiet | 1,8-2,2 m³/min | 1,8-2,2 m³/min | 1,8-2,2 m³/min | 1,8-2,2 m³/min |
| Max. onderdruk | 110 mbar | 110 mbar | 110 mbar | 110 mbar |
| Uitvoering | Stofafzuiging machines | Schoonmaak | Schoonmaak | Stofafzuiging machines |
| Capaciteit stofzak | 2 l | 2 l | 6 l | 6 l |
| AWS | ✓ | - | - | ✓ |
| Gewicht | 3,9 kg | 3,8 kg | 6,1 kg | 6,1 kg |
| Prijs in € | excl. btw | | | |
| | incl. btw | | | |

ACCU RUGGEDRAGEN STOFZUIGERS



VC011G



VC008G



VC009G

(Geleverd zonder batterijen en zonder oplader)



VC011G

Zeer comfortabel harnas

VC008G-VC009G

- Hogere zuigkracht dankzij de 40Vmax accutechnologie
- Geluidsarm door een hertekend design van de luchtuitlaat en gebruik van geluidsabsorberend materiaal.
- VC008GZ wordt standaard geleverd met accessoires voor schoonmaakt toepassingen.
- VC009GZ01 wordt geleverd met twee zuigslangen en hulpstukken voor stofafzuiging in combinatie met machines.

VC011G

- Verhoogde autonomie dankzij 2 x XGT accu's parallel
- Werktijd met 2 x BL4050F: tot 260 min (min vermogen) en 40 min (max vermogen).
- Hoog luchtdebiet en hoge zuigkracht
- Stille werking
- Automatisch zelfreinigende filter
- Zeer comfortabel harnas

VC008GZ VC009GZ01 VC011GZ

| | | | |
|--------------------|---------------|------------------------|---------------|
| Spanning | 36 V (40Vmax) | 36 V (40Vmax) | 36 V (40Vmax) |
| Max. debiet | 2,4 m³/min | 1,9 m³/min | 2,4 m³/min |
| Max. onderdruk | 180 mbar | 180 mbar | 200 mbar |
| Uitvoering | Schoonmaak | Stofafzuiging machines | Schoonmaak |
| Capaciteit stofzak | 2,0 l | 2,0 l | 6,0 l |
| AWS | - | ✓ | - |
| Gewicht | 4,1 - 5,3 kg | 4,1 - 5,3 kg | 6,4 - 9,5 kg |
| Prijs in € | excl. btw | | |
| | incl. btw | | |



VC011GZ

ACCU RECHTOPSTAANDE STOFZUIGER

18V + 18V → 36V

DVC560 - VC010G

- Zeer wendbare alles-in-één stofzuiger (geen netsnoer of zuigslang)
- Hoge stofopname door de combinatie van roterende borstel en stofzuigsysteem, ideaal voor hoogpollige en laagpollige tapijten. Telescopische aluminium handgreep



Instelbare hoogte van de borstel



Geïntegreerde aluminium pijp om moeilijk bereikbare plaatsen te reinigen

de behuizing kan tot 90° scharnieren om gemakkelijk onder meubilair te stofzuigen.

VC010G

- Verhoogde stofopname
- Breder vloerborstel
- 5-traps hoogteverstelling van de borstelrol
- Vloerborstel met zeer laag profiel



DVC560Z



VC010GZ

| | | DVC560Z | VC010GZ |
|---------------------|-----------|--------------|---------------|
| Spanning | | 2 x 18V | 36 V (40Vmax) |
| Bijgeleverde accu's | | - | - |
| Max. debiet | | 1,9 m³/min | 1,8 m³/min |
| Max. onderdruk | | 120 mbar | 150 mbar |
| Gewicht | | 8,3 - 9,0 kg | 8,0 - 9,2 kg |
| Prijs in € | excl. btw | | |
| | incl. btw | | |



ACCU COMPACTE STOFZUIGER

LXT 18V LITHIUM-ION



Inclusief draagriem, vloerzuigmond & kierzuigmond

DVC750LZX1

| | |
|---------------------|------------|
| Spanning | 18V |
| Bijgeleverde accu's | 0 |
| Max. debiet | 1,4 m³/min |
| Max. onderdruk | 64 mbar |
| Gewicht | 4,2 kg |
| Prijs in € | excl. btw |
| | incl. btw |

ACCU COMPACTE STOFZUIGER

12V max LITHIUM-ION

18V LITHIUM-ION

IDEAAL VOOR DE AUTO



DCL184Z

Met blaasfunctie

Inclusief accessoires

CL121DZJ DCL184Z

| | | |
|---------------------|------------|------------|
| Spanning | 10,8V | 18V |
| Bijgeleverde accu's | - | - |
| Lader | - | - |
| Max. debiet | 1,3 m³/min | 1,3 m³/min |
| Max. onderdruk | 44 mbar | 47 mbar |
| Gewicht | 1,7 | 2,1 kg |
| Prijs in € | excl. btw | |
| | incl. btw | |

Zuigmond voor matten



Zuigmond voor zetels



Rubberen zuigmond



Zachte borstel



Blaasmond



ACCU ROBOTSTOFZUIGERS



OPPERVLAKTE
TOT 500 m²

DRC200

- Verschillende sensoren voor obstakel- en grensdetectie
- Patroonmodus voor grote vloeroppervlakken met weinig obstakels, zoals een magazijn of een lange gang
- Willekeurige modus voor vloeroppervlakken met veel obstakels, zoals in een kantoor.
- Door middel van grenstape kan de gebruiker de zone afbakenen waarbinnen de robot mag werken.
- Modi "alleen borstelen" of "stofzuigen + borstelen"
- Bediening op het toestel zelf of met bijgeleverde afstandsbediening
- Werkt op één 18 V accu of twee in parallel. De accu's moeten uit het toestel verwijderd worden om op te laden.



DRC200PTJ

Patroonmodus

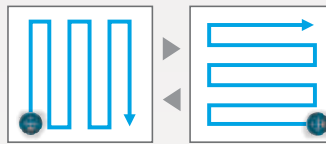

Willekeurige modus

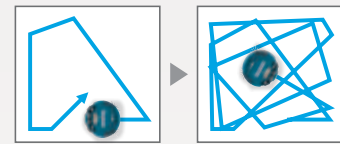

OPPERVLAKTE
TOT 600 m²



DRC300Z

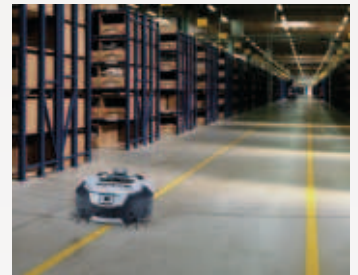

De camera maakt beelden van het plafond ter ondersteuning van de navigatie



DRC300

- Kan ruimtes in kaart brengen door gebruik te maken van LiDAR module en beeldcamera. Tot 5 ruimtes kunnen in het geheugen bewaard worden. Dankzij de intelligente positiebepaling kan een ruimte efficiënter gereinigd worden en kan de machine ook automatisch terugkeren naar het beginpunt
- Verschillende sensoren voor obstakel- en grensdetectie
- Modi "alleen borstelen" of "stofzuigen + borstelen"
- Bediening op het toestel zelf, met de afstandsbediening of met de smartphone app (Wifi verbinding)
- Via de smartphone app kunnen de bewaarde kaarten weergegeven en geoptimaliseerd worden (bv. het definiëren van verboden zones) en kan ook schoonmaakstatus en -historiek gecontroleerd worden
- Werkt op één 18 V accu of twee in parallel. De accu's moeten uit het toestel verwijderd worden om op te laden.

DRC200Z DRC200PTJ DRC300Z

| | | | |
|-----------------------------------|-----------------------------|-----------------------------|--------------------------------|
| Spanning | 18 V (één of 2 in parallel) | | |
| Bijgeleverde accu's | - | 2 x BL1850B | - |
| Lader | - | DC18RD | - |
| Capaciteit opvangbak | 2,5 l | 2,5 l | 3,0 l |
| Max. registreerbare oppervlakte | - | - | 10000 m ² |
| Max. snelheid | 0,3 m/s | 0,3 m/s | 0,3 m/s |
| Navigatie | Willekeurig of vast patroon | Willekeurig of vast patroon | Intelligent op basis van kaart |
| LiDAR sensor | - | - | ✓ |
| Camera | - | - | ✓ |
| Configuratie en besturing met app | - | - | ✓ |
| Afbakenen van verboden zones | Tape | Tape | Tape of via app |
| Terugkeren naar beginpunt | - | - | ✓ |
| Gewicht | 6,8 - 7,8 kg | 6,8 - 7,8 kg | 9,6 - 10,6 kg |
| Prijs in € | excl. btw | | |
| | incl. btw | | |

ACCU STOFZUIGERS L-KLASSE LXT



DVC155LZX2



DVC867LZX4



DVC157LZX3



DVC150LZ DVC155LZX2 DVC867LZX4 DVC157LZX3

| | DVC150LZ | DVC155LZX2 | DVC867LZX4 | DVC157LZX3 |
|-------------------|-------------------------------|-------------------------|-------------------------|-------------------------|
| Spanning | 2 x 18 V / 230 V | 2 x 18 V | 2 x 18 V | 2 x 18 V |
| Bijgeleverde accu | - | - | - | - |
| Kuipvolume | 15 l | 15 l | 8 l | 15 l |
| Type | Nat & Droog | Nat & Droog | Droog | Droog |
| Filter | Textielfilter | Textielfilter | HEPA | HEPA |
| Max. debiet | 2,1 / 3,6 m ³ /min | 2,1 m ³ /min | 2,4 m ³ /min | 2,4 m ³ /min |
| Max. onderdruk | 90 / 240 mbar | 110 mbar | 110 mbar | 110 mbar |
| AWS | - | - | ✓ | ✓ |
| Gewicht | 8,9 kg | 7,9 kg | 7,8 kg | 8,0 kg |
| Prijs in € | excl. btw | | | |
| | incl. btw | | | |

ACCU STOFZUIGERS L-KLASSE XGT



VC003GLZ

VC004GLZ

VC005GLZ



- Voeding met twee 40Vmax accu's in parallel.
- Hoge zuigkracht dankzij hoger vermogen en verbeterde koeling.
- Met telescopische steel (VC001G/VC003G/VC005G)
- Vloerborstel met laag profiel en verstelling voor harde vloer of tapijt (VC001G/VC003G/VC005G).
- VC005G: hoge wendbaarheid en stabiliteit door extra grote wielen achteraan.

Toepassing:

- VC001G / VC003G: voor algemeen droog en nat gebruik (schoonmaak).
- VC002G/VC004G: ideaal voor stofafzuiging van machines (met HEPA filter en AWS).
- VC005G: voor algemeen droog gebruik (schoonmaak).

VC001GLZ VC003GLZ VC002GLZ01 VC004GLZ01 VC005GLZ

| | VC001GLZ | VC003GLZ | VC002GLZ01 | VC004GLZ01 | VC005GLZ |
|---------------------|-------------------------|-------------------------|-------------------------|-------------------------|-------------------------|
| Spanning | 36 V (40Vmax) | 36 V (40Vmax) | 36 V (40Vmax) | 36 V (40Vmax) | 36 V (40Vmax) |
| Bijgeleverde accu's | - | - | - | - | - |
| Type | Droog/Nat | Droog/Nat | Droog | Droog | Droog |
| Capaciteit | 8 l | 15 l | 8 l | 15 l | 8 l |
| Max. debiet | 3,2 m ³ /min | 3,2 m ³ /min | 1,8 m ³ /min | 1,8 m ³ /min | 2,8 m ³ /min |
| Max. onderdruk | 230 mbar | 230 mbar | 230 mbar | 230 mbar | 230 mbar |
| Filter | Textielfilter | Textielfilter | HEPA | HEPA | Textielfilter |
| AWS | - | - | ✓ | ✓ | - |
| Gewicht | 8,1 - 10 kg | 8,1 - 10 kg | 8,3 - 10,2 kg | 8,3 - 10,2 kg | 7,9 - 9,8 kg |
| Prijs in € | excl. btw | | | | |
| | incl. btw | | | | |

WAT BETEKEN L-, M- OF H-KLASSE?

Stofzuigers voor professioneel gebruik worden volgens EN60335-2-69 ingedeeld in risicoklassen:

L-klasse (Low risk) stofzuigers mogen gebruikt worden voor alle stof waarvan de toelaatbare blootstellingswaarde groter is dan 1 mg/m^3 . Deze stofzuigers laten minder dan 1 % van het opgezogen stof door.

M-klasse (Medium risk) stofzuigers mogen gebruikt worden voor alle stof waarvan de toelaatbare blootstellingswaarde groter is dan $0,1 \text{ mg/m}^3$. Deze stofzuigers laten minder dan 0,1 % van het opgezogen stof door en voldoen bovendien aan een aantal bijkomende eisen, waaronder permanente debietcontrole en stofarme lediging.

H-klasse stofzuigers (High risk) moeten gebruikt worden voor stoffen waarvan de max. blootstellingswaarde $< 0,1 \text{ mg/m}^3$ bedraagt. Deze stofzuigers laten minder dan 0,005 % van het opgezogen stof door en moeten ook voldoen aan een aantal bijkomende eisen, zoals permanente debietcontrole en stofarme lediging.

Opgelet: stofzuigers zonder aanduiding van de stofklasse volgens EN60335-2-69 bieden geen enkele garantie op het vlak van persoonlijke veiligheid en zijn derhalve niet geschikt voor professioneel gebruik.

ACCU STOFZUIGERS L-KLASSE XGT



VC007GL, VC006GM: dubbel filtersysteem met automatisch zelfreinigende filter, zonder zuigkrachtonderbreking



- Accu stofzuiger met hoge zuigkracht, vergelijkbaar met model op netstroom
- Stofklasse L, met HEPA-filter
- Nat en droog gebruik, uitgerust met waterniveausensor en waterafvoer
- Automatisch zelfreinigende filter met dubbel filtersysteem
- Inclusief slang 28 mm en 38 mm, gebogen buis en vloerzuigmond
- AWS: de stofzuiger kan automatisch aangestuurd worden door AWS-compatibele powertools

VC007GLZ01

| | |
|---------------------------|-------------------------|
| Spanning | 72 V (80Vmax) |
| Bijgeleverde accu's | - |
| Lader | - |
| Kuipvolume | 40 l |
| Type | nat/droog |
| Filterklasse | L (HEPA) |
| Max. debiet (38 mm slang) | 3,7 m ³ /min |
| Max. debiet (28 mm slang) | 2,0 m ³ /min |
| Max. onderdruk | 180 mbar |
| AWS | ✓ |
| Gewicht | 18,3 - 20,7 kg |
| Prijs in € | excl. btw |
| | incl. btw |

ACCU STOFZUIGERS M-KLASSE XGT



De VG006GM heeft een instelling van de slangdiameter en waarschuwingszoemer voor te lage luchtstroom.



- Accu stofzuiger met hoge zuigkracht, vergelijkbaar met model op netstroom
- Stofklasse M
- Nat en droog gebruik, uitgerust met waterniveausensor en waterafvoer
- Automatisch zelfreinigende filter met dubbel filtersysteem
- Inclusief slang 28 mm en 38 mm, gebogen buis en vloerzuigmond
- AWS: de stofzuiger kan automatisch aangestuurd worden door AWS-compatibele powertools

VC006GMZ01

| | |
|---------------------------|-------------------------|
| Spanning | 72 V (80Vmax) |
| Bijgeleverde accu's | - |
| Lader | - |
| Kuipvolume | 40 l |
| Type | nat/droog |
| Filterklasse | M |
| Max. debiet (38 mm slang) | 3,7 m ³ /min |
| Max. debiet (28 mm slang) | 2,0 m ³ /min |
| Max. onderdruk | 180 mbar |
| AWS | ✓ |
| Gewicht | 18,4 - 20,8 kg |
| Prijs in € | excl. btw |
| | incl. btw |

STOFZUIGERS L-KLASSE

Klasse L
VC2512L

Klasse L
VC2000L

Klasse L
VC3011L

Klasse L
VC3012L

INCLUSIEF
1 SET ACCESSOIRES



STOFZUIGERS L-, M- EN H-KLASSE

Klasse L
VC2510LX1

Klasse L
VC3210LX1

Klasse M
VC3211MX1

Klasse H
VC3211HX1

INCLUSIEF
1 SET ACCESSOIRES



Automatische filterreiniging
zonder zuigkrachtonderbreking.

Automatische filterreiniging
zonder zuigkrachtonderbreking.

STOFZUIGERS L- EN M-KLASSE

Klasse M
VC2211MX1

Klasse L
VC4210LX

Klasse M
VC4210MX

INCLUSIEF
1 SET ACCESSOIRES



Automatische filterreiniging
zonder zuigkrachtonderbreking.

Automatische filterreiniging
zonder zuigkrachtonderbreking.

Automatische filterreiniging
zonder zuigkrachtonderbreking.



| | VC2000L | VC2012L | VC2512L | VC3011L | VC3012L | VC3012M | VC2211MX1 |
|-------------------|------------|------------|------------|------------|------------|------------|------------|
| Nominaal vermogen | 1000 W | 1100 W | 1100 W | 1000 W | 1200 W | 1200 W | 1050 W |
| Max. debiet | 3,6 m³/min | 3,6 m³/min | 3,6 m³/min | 3,6 m³/min | 3,7 m³/min | 3,7 m³/min | 3,5 m³/min |
| Max. onderdruk | 210 mbar | 210 mbar | 210 mbar | 210 mbar | 230 mbar | 230 mbar | 220 mbar |
| Bruto kuipvolume | 20 l | 19 l | 23 l | 30 l | 30 l | 30 l | 22 l |
| Gewicht | 7,5 kg | 7,3 kg | 6,3 kg | 10,5 kg | 10 kg | 10 kg | 16,3 kg |
| Prijs in € | excl. btw | | | | | | |
| | incl. btw | | | | | | |

| | VC2510LX1 | VC3210LX1 | VC3211MX1 | VC3211HX1 | VC4210LX | VC4210MX |
|-------------------|------------|------------|------------|------------|------------|------------|
| Nominaal vermogen | 1050 W | 1050 W | 1050 W | 1050 W | 1200 W | 1200 W |
| Max. debiet | 3,5 m³/min | 3,5 m³/min | 3,5 m³/min | 3,5 m³/min | 4,5 m³/min | 4,5 m³/min |
| Max. onderdruk | 220 mbar | 220 mbar | 220 mbar | 220 mbar | 250 mbar | 250 mbar |
| Bruto kuipvolume | 32 l | 40 l | 40 l | 40 l | 42 l | 42 l |
| Gewicht | 10,5 kg | 14,5 kg | 16,9 kg | 16,9 kg | 15 kg | 15 kg |
| Prijs in € | excl. btw | | | | | |
| | incl. btw | | | | | |

Accuveegmachine 40Vmax VS001G

XGT
40Vmax

BL
MOTOR

XPT
EXTREME PROTECTION TECHNOLOGY



Met de VS001G introduceert Makita een zeer veelzijdige accuveegmachine voor zowel binnen- als buitengebruik. De machine kan zowel fijn stof als ook grover vuil opvangen. Met een werkbreedte van 480 mm (650 mm met zijborstel) is deze efficiënt in te zetten in grotere ruimten en ook op verharde zones in open lucht, maar tegelijkertijd is de machine ook zeer wendbaar en compact.



De krachtpatser die alles opruimt

- De 40Vmax technologie garandeert een hoog vermogen, compacte afmetingen en snelle laadtijden.
- De machine maakt gebruik van een BL motor voor de aandrijving van de hoofdborstels en de zijborstel, een BL motor voor het afzuigsysteem en een derde motor voor het elektrisch schoonmaken van de stoffilter door vibratie.
- Twee borstels die tegen elkaar indraaien nemen zowel het fijnstof op als grover afval op zoals zelfs 500-ml PET flesjes.
- De zijborstel aan de rechtse kant laat toe tot tegen een wand aan te reinigen.
- Het afzuigsysteem met HEPA filter houdt fijnstof tegen.
- De hoogte van zowel de hoofdborstel als zijborstel kan zeer gemakkelijk met een draaiknop ingesteld worden, perfect aangepast aan elke toepassing.

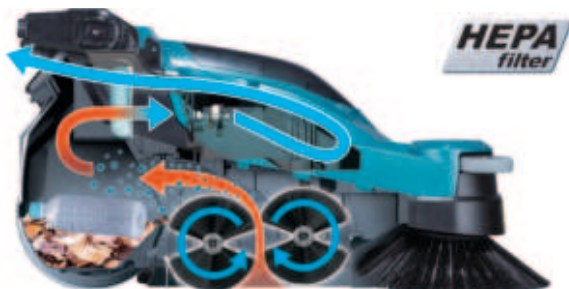

Perfekte controle

- Twee snelheden voor de hoofdborstels onderaan en zijborstel. De lage snelheid maakt de machine extra stil vergroot de autonomie.
- Afzonderlijk inschakelbare zijborstel.
- Afzonderlijk inschakelbare stofafzuiging.
- Activatie van de elektrische filterreiniging.
- Inschakelbare LED verlichting vooraan.

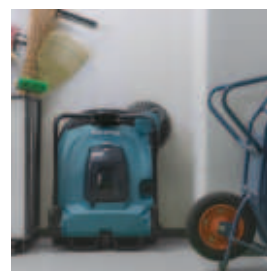

Werkt met één 40Vmax accu, het plaatsen van een tweede vergroot de autonomie. De overschakeling gebeurt automatisch.

Optioneel: multi-adaptor set (1913F5-2) voor het bevestigen van een MACPAC of PDC. De voeding via een PDC vergroot de autonomie.

Optioneel: opvangzak (1913F7-8) met capaciteit van 47 l, ideaal voor grover vuil dat veel plaats inneemt zoals bladeren.

PROMO: GRATIS BL4040F na registratie op www.makita.be bij VS001G

Gemakkelijk te transporteren en op te bergen

- Door het lage gewicht, de opvouwbare duwbeugel en de grote handgreep vooraan is de machine gemakkelijk te transporteren.
- Met een werkbreedte van 480 mm (650 mm met zijborstel) is de machine ook effectief in grotere ruimten maar kan bijvoorbeeld toch ook nog door een deur van 800 mm.
- De machine kan plaatsbesparend verticaal gestockeerd worden.

VS001GZ

| | |
|---|------------------------|
| Spanning | 36 V (40Vmax) |
| Werkbreedte | 480 mm |
| Werkbreedte met zijborstel | 650 mm |
| Capaciteit (stapsnelheid 4 km/u) | 2600 m ² /u |
| Inhoud standaard opvangbox | 24 l |
| Inhoud opvangzak (optioneel) | 47 l |
| Werktijd in vermogenstand 1-2 (accu 2x BL4080F) | 480/200 min |
| Afmetingen (opgevouwen duwbeugel) | 830 x 677 x 467 mm |
| Gewicht | 29.9 - 33.1 kg |
| Prijis in € | excl. btw |
| | incl. btw |

Accu schrob- en polijstmachine 40Vmax PS001G



NIEUW

De PS001G is een zeer veelzijdige schrob- en polijstmachine voor zowel binnen- als buitengebruik. De machine kan uitgerust worden met een borstel of pad om te reinigen, of een pad voor het aanbrengen van was en het polijsten van oppervlakken. Verschillende borstels en pads zijn beschikbaar voor een groot aantal toepassingen. Door zijn compact formaat en uitstekende wendbaarheid is de machine ideaal voor het werken in kleine ruimten zoals badkamers, douches, keukens en terrassen.

Drie snelheden.
Waarschuwinglampje voor lage accucapaciteit.



Verstelbaar handvat met een speciale vorm om gemakkelijk druk te kunnen uitoefenen op de borstel.



De beschermkap voorkomt dat schoonmaakmiddelen zich aan de accu zouden hechten.

XPT (Extreme Protection Technology): goede bescherming tegen indringing van water - op niveau van IPX4.

Telescopische steel met een bereik van 1081 tot 1435 mm.



Efficiënte brushless motor met constante snelheidsregeling.

De flexibele kop volgt het oppervlak perfect waardoor de schijf zeer stabiel draait. Indien gewenst kan de kop ook vastgezet worden met twee hendels.



Verlichting van het werkgebied met twee LED's.



De borstel kan vastgezet en losgemaakt worden zonder deze te moeten aanraken.

De beschermkap voorkomt spatten. Deze kan ook verwijderd worden om dicht tot tegen wanden of in groeven te kunnen schuren.



Vastzetten: de kop op de borstel plaatsen en vooruit laten draaien.



Losmaken: op de borstel duwen en even achteruit laten draaien.

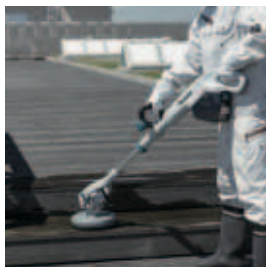

**Reinigen
&
Polijsten**



ACCESSOIRES

Borstels voor reiniging

| | Type | Toepassing | Ref. | Prijs excl. | Prijs incl. |
|---|-------------------------|---|----------|-------------|-------------|
|  | Zacht | Reinigen van houten vloeren en terrassen | 1914T0-6 | | |
|  | Medium* | Reinigen van vloeren binnenshuis | 1914T1-4 | | |
|  | Hard | Reinigen van (beton)vloeren buitenshuis en het verwijderen van hardnekkige (vet)vlekken | 1914T2-2 | | |
|  | Hard (met schuurmiddel) | Reinigen van tegels in porselein of gelijkaardige oppervlakken. | 1914T3-0 | | |

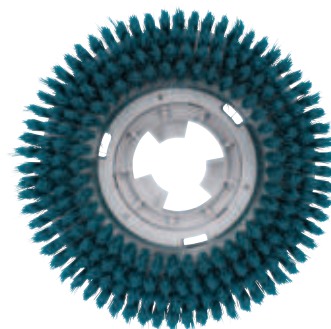

Padhouder en pads voor polijsten

| | Type | Kleur | Toepassing | Ref. | Prijs excl. | Prijs incl. |
|---|-----------------|-------|---|----------|-------------|-------------|
|  | Zacht* | Wit | Polijsten van oppervlakken met was | 1914S5-9 | | |
|  | Medium* | Rood | Polijsten van oppervlakken met was | 1914S6-7 | | |
|  | Medium* | Blauw | Reingen | 1914S7-5 | | |
|  | Ruw | Zwart | Verwijderen van was | 1914S9-1 | | |
|  | Pad houder set* | | Met velcro opname, voor het monteren van pads | 1914S4-1 | | |



* Standaard geleverd bij PS001GZ



Waterbestendige tas

Geschikt om vochtige accessoires op te bergen.
1915D1-8
excl.
incl.

| | | PS001GZ |
|---------------------------|-----------|----------------------------------|
| Spanning | | 36 V (40Vmax) |
| Onbelast toerental | | 150 / 350 / 600 mm ⁻¹ |
| Bijgeleverde accu's/lader | | - |
| Diameter borstel | | 190 mm |
| Diameter/dikte pad | | 200 mm / 25 mm |
| Lengte | | 1081 - 1435 mm |
| Automatische watertoevoer | | Neen |
| Gewicht (BL4020-BL4080F) | | 4,4 kg - 5,6 kg |
| Prijs in € | excl. btw | |
| | incl. btw | |

Vrijblijvende adviesprijs van de fabrikant in euro.



BOORHAMERS SDS-PLUS 2 FUNCTIES



| | HR2600 | HR1841FJ | HR2800 |
|---------------------------|-----------------------|----------------------|---------------------|
| Nominaal vermogen | 800 W | 470 W | 800 W |
| Slagenergie | 2,4 J | 1,4 J | 2,8 J |
| Max. Ø beton | 26 mm | 18 mm | 28 mm |
| AVT | - | ✓ | - |
| Vibratieniveau hamerboren | 15,5 m/s ² | 7,5 m/s ² | 20 m/s ² |
| Gewicht | 2,8 kg | 2,5 kg | 3,4 kg |
| Prijs in € | excl. btw | | |
| | incl. btw | | |

COMBIHAMERS SDS-PLUS 3 FUNCTIES



Inclusief automatische boorkop bij HR2630X7

Inclusief Boor- en beitelset 17 stuks bij HR2670FTX2 en HR2631FT12 t.w.v.



- HR2670/HR2670FTX2**
- De krachtige 800 W motor levert 3,0 J slagenergie
 - Hoogste boorsnelheid in zijn klasse
 - Verhoogde duurzaamheid door herziening van de mechaniek
 - HR2670FTX2: met verwisselbare boorkop en LED licht.

| | HR2470 | HR2630X7 | HR2670 | HR2670FTX2 | HR2631FT12 | HR2811FT |
|---------------------------|-----------------------|---------------------|-----------------------|-----------------------|-----------------------|---------------------|
| Nominaal vermogen | 780 W | 800 W | 800 W | 800 W | 800 W | 800 W |
| Slagenergie | 2,4 J | 2,4 J | 3,0 J | 3,0 J | 2,4 J | 2,9 J |
| Max. Ø beton | 24 mm | 26 mm | 26 mm | 26 mm | 26 mm | 28 mm |
| AVT | - | - | - | - | ✓ | - |
| Vibratieniveau hamerboren | 15,5 m/s ² | 15 m/s ² | 16,1 m/s ² | 15,7 m/s ² | 11,5 m/s ² | 15 m/s ² |
| Verwisselbare boorkop | - | - | - | ✓ | ✓ | ✓ |
| Gewicht | 2,9 - 3,3 kg | 2,8 - 3,3 kg | 2,9 - 3,4 kg | 2,9 - 3,4 kg | 2,9 kg | 3,6 - 3,9 kg |
| Prijs in € | excl. btw | | | | | |
| | incl. btw | | | | | |

COMBIHAMERS SDS-PLUS MET STOF AFZUIGING



Inclusief boor- en beitelset 17 stuks bij HR2651TX12 t.w.v.

Inclusief stofafzuigingsunit DX11 bij HR3012FCWJ



| | HR2651TX12 | HR3012FCWJ |
|---------------------------|-----------------------|----------------------|
| Nominaal vermogen | 800 W | 1050 W |
| Slagenergie | 2,2 J | 3,9 J |
| Max. Ø beton | 26 mm | 30 mm |
| AVT | ✓ | ✓ |
| Vibratieniveau hamerboren | 11,5 m/s ² | 9,5 m/s ² |
| Gewicht | 4,2 kg | 4,4 kg |
| Prijs in € | excl. btw | |
| | incl. btw | |

COMBIHAMERS SDS-PLUS



HR3210FCT

HR3210FCT:
met anti-vibratie
handgreep

INCLUSIEF
1 automatische
boorkop (194568-7)
bij HR3210FCT



| | HR3200C | HR3210FCT |
|---------------------------|---------------------|---------------------|
| Nominaal vermogen | 850 W | 850 W |
| Slagenergie | 5,1 J | 4,9 J |
| Max. Ø beton | 32 mm | 32 mm |
| AVT | - | ✓ |
| Vibratieniveau hamerboren | 18 m/s ² | 10 m/s ² |
| Gewicht | 4,8 kg | 5,4 kg |
| Prijs in € | excl. btw | |
| | incl. btw | |

COMBIHAMERS SDS-MAX



gratis 5-delige
boor- en beitelset
P-52445 bij HR4013C, HR4511C
en HR5212C
t.w.v.



HR4013CV

CV-modellen
inclusief
stofafzuigset

| | HR3541FCX | HR4013C | HR4013CV | HR4511C | HR4511CV | HR5212C |
|---------------------------|---------------------|----------------------|----------------------|----------------------|----------------------|-----------------------|
| Nominaal vermogen | 850 W | 1100 W | 1100 W | 1350 W | 1350 W | 1500 W |
| Slagenergie | 5,7 J | 8,0 J | 8,0 J | 9,4 J | 9,4 J | 18,9 J |
| Max Ø beton | 35 mm | 40 mm | 40 mm | 45 mm | 45 mm | 52 mm |
| AVT | ✓ | ✓ | ✓ | ✓ | ✓ | ✓ |
| Vibratieniveau hamerboren | 11 m/s ² | 5,0 m/s ² | 5,0 m/s ² | 7,5 m/s ² | 7,5 m/s ² | 12,5 m/s ² |
| Gewicht | 5,6 kg | 6,8 kg | 6,8 kg | 8,8 kg | 8,8 kg | 12,1 kg |
| Prijs in € | excl. btw | | | | | |
| | incl. btw | | | | | |

STOFZUIGSET VOOR BOOR-EN BREEKHAMERS

Hamerboren

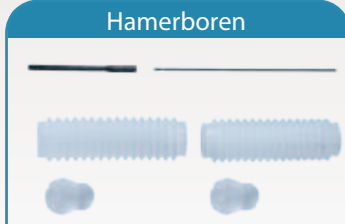

Beitelen



| | 199142-6 | 195866-2 | 196858-4 |
|------------|-----------|----------|----------|
| | HR4013C | HR4511C | HR5212C |
| Prijs in € | excl. btw | | |
| | incl. btw | | |

BIKHAMERS SDS-PLUS



HK1820

| | HK0500 | HK1820 |
|-------------------------------|----------------------|---------------------|
| Nominaal vermogen | 550 W | 550 W |
| Slagfrequentie | 2000-3500 /min | 0-3200 /min |
| Slagenergie | 1,8 J | 3,1 J |
| AVT | - | - |
| Triaxiale vibratiewaarde (ah) | 9,5 m/s ² | 10 m/s ² |
| Gewicht | 3,2 kg | 3,4 kg |
| Prijs in € | excl. btw | |
| | incl. btw | |

BREEKHAMERS SDS-MAX



HM1213C

PROMO
gratis 5-delige
beitelset
E-20236 bij
HM0871C

Wist u dat u tijdens de garantieperiode recht hebt op één gratis onderhoudsbeurt? Ontdek er meer over op www.makita.be



SOFT NO LOAD



HM0871C



HM1214C

CV-modellen
inclusief
stofafzuigset

| | HM0870C | HM0871C | HM1101C |
|-------------------------------|-----------------------|--------------------|-----------------------|
| Nominaal vermogen | 1100 W | 1100 W | 1300 W |
| Slagfrequentie | 1100-2650 /min | 1100-2650 /min | 1100-2600 /min |
| Slagenergie | 7,6 J | 8,1 J | 11,5 J |
| AVT | - | ✓ | - |
| Triax. vibratie beitelen (ah) | 11,5 m/s ² | 8 m/s ² | 13,5 m/s ² |
| Gewicht | 5,1 kg | 5,8 kg | 7 kg |
| Prijs in € | excl. btw | | |
| | incl. btw | | |

| | HM1111C | HM1203C | HM1213C | HM1214C |
|-------------------------------|--------------------|-----------------------|--------------------|--------------------|
| Nominaal vermogen | 1300 W | 1510 W | 1510 W | 1510 W |
| Slagfrequentie | 1100-2600 /min | 950-1900 /min | 950-1900 /min | 950-1900 /min |
| Slagenergie | 11,2 J | 19,1 J | 18,6 J | 19,9 J |
| AVT | ✓ | - | ✓ | ✓ |
| Triax. vibratie beitelen (ah) | 8 m/s ² | 15,5 m/s ² | 7 m/s ² | 8 m/s ² |
| Gewicht | 7,7 kg | 9,7 kg | 10,8 kg | 12,3 kg |
| Prijs in € | excl. btw | | | |
| | incl. btw | | | |

STOFAFZUIGING BREEKHAMERS



199144-2



197168-2

| | | 199144-2 | 197168-2 |
|---------------|------------|------------------------|---------------------|
| Geschikt voor | | Breekhamers SDS-Max | HM1812 / HM1317C |
| | Prijs in € | excl. btw | |
| | | incl. btw | |

**SOFT
NO LOAD**

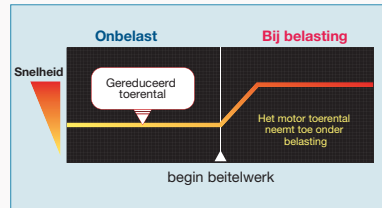

Reduceert automatisch het toerental van de machine om ongewenste trillingen verder te reduceren.

BREEKHAMERS MET ZESKANTOPNAME



**SOFT
NO LOAD** **AVT**
ANTI VIBRATION TECHNOLOGY



HM1812

HM1812:
slagenergie 72,8 J

GRATIS trolley JM00000674 bij HM1812



HM1511

HM1511/HM1512:
slagenergie 48,9 J

HM1511 / HM1512 :
Uitzonderlijk laag trillings-niveau door anti-vibratie behuizing, actieve trillingsdemping en de soft-no-load regeling



| | HM1317C | HM1511 | HM1512 | HM1812 |
|-------------------------------|----------------------|----------------------|----------------------|----------------------|
| Nominaal vermogen | 1510 W | 1850 W | 1850 W | 2000 W |
| Slagfrequentie | 730-1450 /min | 1300 /min | 1300 /min | 870 /min |
| Slagenergie | 25 J | 48,9 J | 48,9 J | 72,8 J |
| AVT | ✓ | ✓ | ✓ | ✓ |
| Triax. vibratie beitelen (ah) | 8,5 m/s ² | 6,5 m/s ² | 6,5 m/s ² | 6,5 m/s ² |
| Opname hex. | 30 mm | 30 mm | 28,6 mm | 28,6 mm |
| Gewicht | 17 kg | 19,2 kg | 20,4 kg | 31,3 kg |
| Prijs in € | excl. btw | | | |
| | incl. btw | | | |

KLOPBOORMACHINES



HP2071FJ

HP1631KSP HP2051FHJ HP2071FJ

| | HP1631KSP | HP2051FHJ | HP2071FJ |
|-------------------|---------------|---------------|---------------|
| Nominaal vermogen | 710 W | 720 W | 1010 W |
| Toerental | 0-3200 t.p.m. | 0-2900 t.p.m. | 0-2900 t.p.m. |
| Ø Max. staal | 13 mm | 13 mm | 18 mm |
| Ø Max. hout | 30 mm | 40 mm | 40 mm |
| Ø Max. steen | 16 mm | 20 mm | 20 mm |
| Boorkop | 1,5-13 mm | 1,5-13 mm | 1,5-13 mm |
| Makpac | - | ✓ | ✓ |
| Gewicht | 2 kg | 2,5 kg | 2,6 kg |
| Prijs in € | excl. btw | | |
| | incl. btw | | |

BOORMACHINES



DP4011

DP4021

DP4011
Met 2 snelheden

DP2011 DP4003 DP4011 DP4021

| | DP2011 | DP4003 | DP4011 | DP4021 |
|-------------------|---------------|--------------|---------------|-----------------|
| Nominaal vermogen | 370 W | 750 W | 720 W | 630 W |
| Toerental | 0-4200 t.p.m. | 0-700 t.p.m. | 0-2900 t.p.m. | 0 - 3000 t.p.m. |
| Ø Max. staal | 6,5 mm | 13 mm | 13 mm | 13 mm |
| Ø Max. hout | 15 mm | 38 mm | 40 mm | 30 mm |
| Boorkop | 0,8-6,5 mm | 1,5-13 mm | 1,5-13 mm | 1,5-13 mm |
| Gewicht | 1,1 kg | 2,4 kg | 2,3 kg | 1,6 kg |
| Prijs in € | excl. btw | | | |
| | incl. btw | | | |

DIAMANTKERNBOORMACHINES



DBM131W

DBM131W / DBM230W
Geleverd met boorstandaard



DBM131 DBM131W DBM230W

| | DBM131 | DBM131W | DBM230W |
|----------------------|-------------|-------------|-------------|
| Nominaal vermogen | 1700 W | 1700 W | 2500 W |
| Toerental onbelast 1 | 1100 t.p.m. | 1100 t.p.m. | 390 t.p.m. |
| Toerental onbelast 2 | 2300 t.p.m. | 2300 t.p.m. | 1040 t.p.m. |
| Toerental onbelast 3 | - | - | 1700 t.p.m. |
| Opname | M18 | M18 | 1-1/4"UNC |
| Ø Max. beton | 132 mm | 132 mm | 230 mm |
| Gewicht | 6,1 kg | 6,1 kg | 6,9 kg |
| Prijs in € | excl. btw | | |
| | incl. btw | | |

ACCESSOIRES



Diamantboren

Nieuwe beton diamantkernboren voor nat gebruik.

- Langere levensduur dankzij lasergelaste segmenten.
- Totale lengte verhoogd naar 450mm.
- Snellere boorprestatie dankzij chevron-vormige diamantdeeltjes.

| Omschrijving | Best. nr. | Ø | Lengte | Opname | Stuks | Prijs excl. btw | Prijs incl. btw |
|-----------------|-----------|--------|--------|-----------|-------|-----------------|-----------------|
| Diamantkernboor | E-19869 | 32 mm | 450 mm | 1-1/4"UNC | 1 | | |
| Diamantkernboor | E-19875 | 42 mm | 450 mm | 1-1/4"UNC | 1 | | |
| Diamantkernboor | E-19881 | 52 mm | 450 mm | 1-1/4"UNC | 1 | | |
| Diamantkernboor | E-19897 | 62 mm | 450 mm | 1-1/4"UNC | 1 | | |
| Diamantkernboor | E-19906 | 68 mm | 450 mm | 1-1/4"UNC | 1 | | |
| Diamantkernboor | E-19912 | 72 mm | 450 mm | 1-1/4"UNC | 1 | | |
| Diamantkernboor | E-19928 | 82 mm | 450 mm | 1-1/4"UNC | 1 | | |
| Diamantkernboor | E-19934 | 92 mm | 450 mm | 1-1/4"UNC | 1 | | |
| Diamantkernboor | E-19940 | 102 mm | 450 mm | 1-1/4"UNC | 1 | | |
| Diamantkernboor | E-19956 | 107 mm | 450 mm | 1-1/4"UNC | 1 | | |
| Diamantkernboor | E-19962 | 112 mm | 450 mm | 1-1/4"UNC | 1 | | |

| Omschrijving | Best. nr. | Ø | Lengte | Opname | Stuks | Prijs excl. btw | Prijs incl. btw |
|-----------------|-----------|--------|--------|-----------|-------|-----------------|-----------------|
| Diamantkernboor | E-19978 | 117 mm | 450 mm | 1-1/4"UNC | 1 | | |
| Diamantkernboor | E-19984 | 122 mm | 450 mm | 1-1/4"UNC | 1 | | |
| Diamantkernboor | E-19990 | 127 mm | 450 mm | 1-1/4"UNC | 1 | | |
| Diamantkernboor | E-20002 | 132 mm | 450 mm | 1-1/4"UNC | 1 | | |
| Diamantkernboor | E-20018 | 142 mm | 450 mm | 1-1/4"UNC | 1 | | |
| Diamantkernboor | E-20024 | 152 mm | 450 mm | 1-1/4"UNC | 1 | | |
| Diamantkernboor | E-20030 | 162 mm | 450 mm | 1-1/4"UNC | 1 | | |
| Diamantkernboor | E-20046 | 172 mm | 450 mm | 1-1/4"UNC | 1 | | |
| Diamantkernboor | E-20052 | 182 mm | 450 mm | 1-1/4"UNC | 1 | | |
| Diamantkernboor | E-20068 | 202 mm | 450 mm | 1-1/4"UNC | 1 | | |
| Diamantkernboor | E-20074 | 212 mm | 450 mm | 1-1/4"UNC | 1 | | |



P-42151

ADAPTER M18 NAAR 1-1/4" UNC
EXCL. BTW:

HAakse BOORMACHINES



DA3010FJ

| | | DA3010FJ |
|-------------------|-----------|---------------|
| Nominaal vermogen | | 450 W |
| Toerental | | 0-2400 t.p.m. |
| Ø Max. staal | | 10 mm |
| Ø Max. hout | | 25 mm |
| Boorkop | | 1-10 mm |
| Gewicht | | 1,6 kg |
| Prijs in € | excl. btw | |
| | incl. btw | |

KERNBOORMACHINE MET MAGNEETVOET



| | | HB350 | HB500 |
|------------------------|-----------|-------------|-------------|
| Nominaal vermogen | | 1050 W | 1150 W |
| Toerental onbelast 1 | | 450 t.p.m. | 350 t.p.m. |
| Toerental onbelast 2 | | 850 t.p.m. | 650 t.p.m. |
| Ø Max. staal | | 35 mm | 50 mm |
| Klemkracht magneetvoet | | 8000 N | 9300 N |
| Opname | | 3/4" WELDON | 3/4" WELDON |
| Gewicht | | 11,5 kg | 18,5 kg |
| Prijs in € | excl. btw | | |
| | incl. btw | | |

MENGERS



UT1600

| | | UT1400 | UT1401 | UT1600 |
|-----------------------|-----------|--------------|--------------|--------------|
| Nominaal vermogen | | 1150 W | 1150 W | 1600 W |
| Toerental onbelast 1 | | 0-900 t.p.m. | 0-400 t.p.m. | 0-440 t.p.m. |
| Toerental onbelast 2 | | - | 0-730 t.p.m. | 0-970 t.p.m. |
| Toerental belast max. | | 0-580 t.p.m. | 0-450 t.p.m. | 0-580 t.p.m. |
| Schroefdraad spindel | | M14 | M14 | M14 |
| Gewicht | | 5,2 kg | 5,5 kg | 7,1 kg |
| Prijs in € | excl. btw | | | |
| | incl. btw | | | |

BOORMACHINE / MENGER



| | | DS4012 |
|-------------------|-----------|------------|
| Nominaal vermogen | | 750 W |
| Toerental | | 600 t.p.m. |
| Ø Max. staal | | 13 mm |
| Ø Max. hout | | 36 mm |
| Boorkop | | 2-13 mm |
| Gewicht | | 2,8 kg |
| Prijs in € | excl. btw | |
| | incl. btw | |

SCHROEFAUTOMATEN

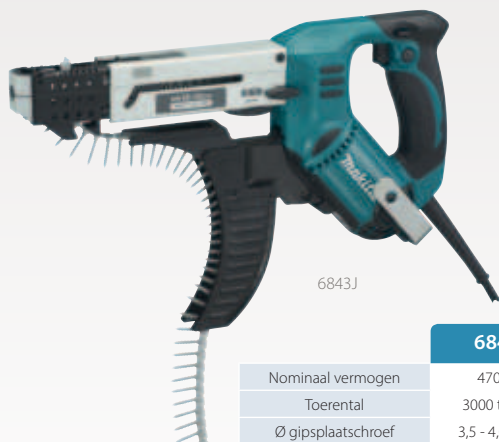

6843J

| | | 6844 | 6843J |
|--------------------|-----------|--------------|--------------|
| Nominaal vermogen | | 470 W | 470 W |
| Toerental | | 3000 t.p.m. | 6000 t.p.m. |
| Ø gipsplaatschroef | | 3,5 - 4,0 mm | 3,5 - 4,0 mm |
| Schroeflengte | | 45-75 mm | 25-55 mm |
| Verpakking | | Koffer | Makpac |
| Gewicht | | 2 kg | 2 kg |
| Prijs in € | excl. btw | | |
| | incl. btw | | |

SCHROEFMACHINES VOOR GIPSPLAAT



FS2500K: met 1/4" Hex bitopname



FS2500



FS2701K

FS2701K: met koppeling met 6 stappen



schroeflintadapter 191L24-0

79 incl. btw

| | | FS2300K | FS2500K | FS2701K | FS6300RJX2 |
|--------------------------|-----------|---------------|---------------|---------------|---------------|
| Nominaal vermogen | | 570 W | 570 W | 570 W | 570 W |
| Toerental | | 0-2500 t.p.m. | 0-2500 t.p.m. | 0-2500 t.p.m. | 0-6000 t.p.m. |
| Ø gipsplaatschroef | | 5 mm | 5 mm | 5 mm | 5 mm |
| Incl. schroeflintadapter | | - | - | - | ✓ |
| Gewicht | | 1,7 kg | 1,6 kg | 1,7 kg | 1,4 kg |
| Prijs in € | excl. btw | | | | |
| | incl. btw | | | | |

COMFORTABEL WERKEN MET SUPER JOINT SYSTEM II

Zonder SJS

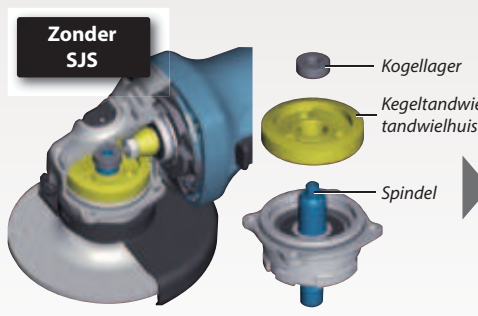





Bladveer absorbeert trillingen en vermindert schokken tijdens het werken

HAAKSE SLIJPER 125 MM



GA5034



GA5030RSP2

| | GA5034 | GA5030RK | GA5030RSP2 |
|--------------------|--------------|--------------|--------------|
| Nominaal vermogen | 720 W | 720 W | 720 W |
| Toerental | 11000 t.p.m. | 11000 t.p.m. | 11000 t.p.m. |
| Ø schijf | 125 mm | 125 mm | 125 mm |
| Dodemansschakelaar | ✓ | - | - |
| Gewicht | 1,9 kg | 1,8 kg | 1,8 kg |
| Prijs in € | excl. btw | | |
| | incl. btw | | |

HAAKSE SLIJPER 115 MM



GA4530RK

| | GA4530RK |
|-------------------|--------------|
| Nominaal vermogen | 720 W |
| Toerental | 11000 t.p.m. |
| Ø schijf | 115 mm |
| Gewicht | 1,8 kg |
| Prijs in € | excl. btw |
| | incl. btw |

HAAKSE SLIJPER 125 MM



9558HNRGK3

125 MM

9558HNRGK3:
geleverd met
1 afbraamschijf en
2 diamantschijven



9558HPGY is uitgerust met een dodemans-schakelaar: de motor schakelt uit bij loslaten van schakelaar voor verhoogde veiligheid.

| | 9558HNRGZ | 9558HPGY | 9558HNRGK3 |
|--------------------|--------------|--------------|--------------|
| Nominaal vermogen | 840 W | 840 W | 840 W |
| Toerental | 11000 t.p.m. | 11000 t.p.m. | 11000 t.p.m. |
| Ø schijf | 125 mm | 125 mm | 125 mm |
| Dodemansschakelaar | - | ✓ | - |
| Gewicht | 2,1 kg | 2,1 kg | 2,1 kg |
| Prijs in € | excl. btw | | |
| | incl. btw | | |

HAAKSE SLIJPER 125 MM X-LOCK



GA5080RX03

GA5080RX03

| | |
|-------------------|--------------|
| Nominaal vermogen | 1400 W |
| Toerental | 12000 t.p.m. |
| Ø schijf | 125 mm |
| Verpakking | Makpac |
| Gewicht | 2,5 – 3,6 kg |
| Prijs in € | excl. btw |
| | incl. btw |

HAAKSE SLIJPERS 125 MM



GA5040C



SA5040C

| | GA5040RZ | GA5040RKDJ | GA5040C | GA5040CJD | SA5040C |
|--------------------------|------------------------------------|------------------------------------|------------------------------------|------------------------------------|------------------------------------|
| Nominaal vermogen | 1100 W | 1100 W | 1400 W | 1400 W | 1400 W |
| Toerental | 11000 t.p.m. | 11000 t.p.m. | 2800-11000 t.p.m. | 2800-11000 t.p.m. | 2000-7800 t.p.m. |
| Heropstartbeveiliging | ✓ | ✓ | ✓ | ✓ | ✓ |
| Mechanische rem | - | - | - | - | - |
| Type schakelaar | Schuifschakelaar met vergrendeling | Schuifschakelaar met vergrendeling | Schuifschakelaar met vergrendeling | Schuifschakelaar met vergrendeling | Schuifschakelaar met vergrendeling |
| Verpakking | Karton | Makpac | Karton | Makpac | Karton |
| Gewicht | 2,4 kg | 2,4 kg | 2,4 kg | 2,4 kg | 2,2 kg |
| Meegeleverde accessoires | - | 2 x diamantschijf | - | 2 x diamantschijf | - |
| Prijs in € | excl. btw | | | | |
| | incl. btw | | | | |

HAAKSE SLIJPERS 125 MM / 150 MM



9565PCV01

9565PCV01 & 9566PCV01:
Antivibratiehandgreep en dodemansschakelaar.



GA5050R: grote lepelschakelaar + gereedschaploze beschermkap

| | GA5050R | 9565CRX1 | 9565PCV01 | GA6040C | 9565HRZ | 9565CVR |
|-----------------------|--------------------------------------|------------------------------------|--------------------------------------|------------------------------------|------------------------------------|------------------------------------|
| Nominaal vermogen | 1300 W | 1400 W | 1400 W | 1400 W | 1100 W | 1400 W |
| Toerental | 11000 t.p.m. | 11000 t.p.m. | 2800-11500 t.p.m. | 4000-9000 t.p.m. | 12000 t.p.m. | 2800 - 12000 t.p.m. |
| SJS | - | ✓ | ✓ | ✓ | ✓ | ✓ |
| Ø schijf | 125 mm | 125 mm | 125 mm | 150 mm | 125 mm | 125 mm |
| Type schakelaar | Lepelschakelaar zonder vergrendeling | Schuifschakelaar met vergrendeling | Lepelschakelaar zonder vergrendeling | Schuifschakelaar met vergrendeling | Schuifschakelaar met vergrendeling | Schuifschakelaar met vergrendeling |
| Heropstartbeveiliging | ✓ | ✓ | - | ✓ | ✓ | ✓ |
| Gewicht | 2,5 kg | 2,6 kg | 2,6 kg | 2,6 kg | 2,3 kg | 2,3 kg |
| Prijs in € | excl. btw | | | | | |
| | incl. btw | | | | | |

HAAKSE SLIJPERS 125 MM



GA5021CY

GA5021CYX1:
Inclusief antivibratiegreep en Ezynut sluitmoer

| | GA5021C | GA5021CY | GA5021CYX1 |
|--------------------|--------------|--------------|--------------|
| Nominaal vermogen | 1450 W | 1450 W | 1450 W |
| Toerental | 10000 t.p.m. | 10000 t.p.m. | 10000 t.p.m. |
| Ø schijf | 125 mm | 125 mm | 125 mm |
| Dodemansschakelaar | - | ✓ | ✓ |
| Gewicht | 3 kg | 3 kg | 3 kg |
| Prijs in € | excl. btw | | |
| | incl. btw | | |

10x
Doorslijpschijven
in blik



| Ref. | Ø (mm) | Dikte (mm) | Ø asgat (mm) | Prijs | |
|------------|--------|------------|--------------|-----------|-----------|
| | | | | excl. btw | incl. btw |
| D-18770-10 | 125 | 1,2 | 22,23 | | |

HAAKSE SLIJPERS 125 MM

- Bestand tegen langdurige hoge belasting dankzij verbeterde koeling
- Greepomtrek van slechts 205 mm
- Mechanische rem (GA5091, GA5093, GA5094)
- De AFT functie stopt de motor ogenblikkelijk wanneer de schijf blokkeert

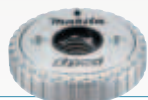

PROMO

gratis snelsluitmoer EZYNUT 195354-9

| | GA5092X01 | GA5090X01 | GA5091X01 | GA5095X01 | GA5094 | GA5093X01 |
|--------------------|-------------------------|------------------------------|------------------------------|-------------------------|-------------------------|------------------------------|
| Nominaal vermogen | 1900 W | 1900 W | 1900 W | 1900 W | 1900 W | 1900 W |
| Toerental | 11500 min ⁻¹ | 2800-11500 min ⁻¹ | 2800-11500 min ⁻¹ | 11500 min ⁻¹ | 11500 min ⁻¹ | 2800-11500 min ⁻¹ |
| Variabel toerental | - | ✓ | ✓ | - | - | ✓ |
| Mechanische rem | - | - | ✓ | - | ✓ | ✓ |
| Type Schakelaar | Schuifschakelaar | Schuifschakelaar | Schuifschakelaar | Lepelschakelaar | Lepelschakelaar | Lepelschakelaar |
| Dodemansschakelaar | - | - | - | ✓ | ✓ | ✓ |
| Gewicht | 2,6 - 3,8 kg | 2,6 - 3,8 kg | 2,8 - 4,0 kg | 2,7 - 3,8 kg | 2,9 - 4,0 kg | 2,9 - 4,0 kg |
| Prijs in € | excl. btw | | | | | |
| | incl. btw | | | | | |

ACCESSOIRES

| | Omschrijving | Artikel | Diameter | Dikte | Asgat | Reductiering | Specificatie | Hoogte segment | Verpakkings-eenheid | Prijs excl. btw | Prijs incl. btw |
|------------|-------------------------------------|------------|----------|--------|----------|--------------|--------------|----------------|---------------------|-----------------|-----------------|
| NEW | Doorslijpschijf staal | P-53023 | 125 mm | 1,0 mm | 22,23 mm | | A60R-BF | | 1 | | |
| | Doorslijpschijf inox | P-53045 | 125 mm | 1,0 mm | 22,23 mm | | A60S-BF | | 1 | | |
| | Doorslijpschijf inox 'Fast cutting' | E-22953 | 125 mm | 0,8 mm | 22,23 mm | | Z60V-BF | | 1 | | |
| | Doorslijpschijf inox 'Fast cutting' | E-22953-12 | 125 mm | 0,8 mm | 22,23 mm | | Z60V-BF | | 12 | | |
| | Diamantschijf Comet | B-12778 | 125 mm | 2,0 mm | 22,23 mm | 20 mm | | 10 mm | 1 | | |
| | Doorslijpschijf staal | P-05773 | 230 mm | 2,5 mm | 22,23 mm | | A30S4-BF | | 1 | | |
| | Doorslijpschijf inox | E-13764 | 230 mm | 1,9 mm | 22,23 mm | | A60U-BF | | 1 | | |
| | Diamantschijf Nebula | B-54025 | 230 mm | 2,4 mm | 22,23 mm | 20 mm | | 10 mm | 1 | | |

BORSTELS VOOR SLIJPERS

| | Artikel | Diameter | Draaddikte | Draadtype | Opname | Toepassing | Prijs excl. btw | Prijs incl. btw |
|--|---------|----------|------------|---------------|--------|-----------------------------------|-----------------|-----------------|
| | D-77453 | 75 | 0,3 mm | RVS, gegolfd | M14 | Ruwe oppervlakte | | |
| | D-77497 | 75 | 0,3 mm | RVS, geknoopt | M14 | Ruwe oppervlakte, snel | | |
| | D-77512 | 115 | 0,3 mm | RVS, gegolfd | M14 | Plaatselijke behandeling, recht | | |
| | D-77562 | 115 | 0,3 mm | RVS, gegolfd | M14 | Plaatselijke behandeling, gebogen | | |
| | D-77534 | 115 | 0,3 mm | RVS, geknoopt | M14 | Hoeken, recht | | |
| | D-77584 | 115 | 0,3 mm | RVS, geknoopt | M14 | Hoeken, gebogen | | |

HAAKSE SLIJPERS 180 MM



GA7082

GA7070X1

| | GA7050 | GA7082 | GA7070X1 | GA7070YX1 |
|--------------------------|-------------|-------------|--------------|--------------|
| Nominaal vermogen | 2000 W | 2800 W | 2800 W | 2800 W |
| Toerental | 8500 t.p.m. | 8500 t.p.m. | 8500 t.p.m. | 8500 t.p.m. |
| Dodemansschakelaar | ✓ | - | - | ✓ |
| Draibare achterhandgreep | - | - | ✓ | ✓ |
| Mechanische rem | - | - | ✓ | ✓ |
| Gewicht | 4,5 kg | 6,0 kg | 6,2 - 6,7 kg | 6,1 - 6,6 kg |
| Prijs in € | excl. btw | | | |
| | incl. btw | | | |

HAAKSE SLIJPERS 230 MM



GA9061R

GA9082



GA9060KD

Incl. diamantschijf

| | GA9050 | GA9060 | GA9060KD | GA9082 | GA9061R |
|--------------------------|-------------|-------------|-------------|-------------|-------------|
| Nominaal vermogen | 2000 W | 2200 W | 2200 W | 2700 W | 2200 W |
| Toerental | 6600 t.p.m. | 6600 t.p.m. | 6600 t.p.m. | 6600 t.p.m. | 6600 t.p.m. |
| Soft start | - | - | - | ✓ | ✓ |
| Dodemansschakelaar | ✓ | ✓ | ✓ | - | - |
| Draibare achterhandgreep | - | - | - | - | - |
| Heropstartbeveiliging | - | - | - | - | ✓ |
| Gewicht | 4,7 kg | 5,6 kg | 5,6 kg | 6,1 kg | 5,7 kg |
| Prijs in € | excl. btw | | | | |
| | incl. btw | | | | |

HAAKSE SLIJPERS 230 MM



GA9040RF01

GA9030SF01

GA9070YX1

GA9071YX1:
Met gesloten handgreep

| | GA9030SF01 | GA9030RF01 | GA9040SF01 | GA9040RF01 | GA9080X1 | GA9070YX1 | GA9071YX1 |
|---------------------------|-------------|-------------|-------------|-------------|-------------|--------------|--------------|
| Nominaal vermogen | 2400 W | 2400 W | 2600 W | 2600 W | 2700 W | 2800 W | 2800 W |
| Toerental | 6600 t.p.m. | 6600 t.p.m. | 6600 t.p.m. | 6600 t.p.m. | 6600 t.p.m. | 6600 t.p.m. | 6600 t.p.m. |
| Dodemansschakelaar | ✓ | - | ✓ | - | - | ✓ | ✓ |
| Draibare achterhandgreep | ✓ | ✓ | ✓ | ✓ | ✓ | ✓ | ✓ |
| Antivibratie zijhandgreep | ✓ | ✓ | ✓ | ✓ | - | ✓ | ✓ |
| Soft start | ✓ | ✓ | ✓ | ✓ | ✓ | ✓ | ✓ |
| Heropstartbeveiliging | - | ✓ | - | ✓ | ✓ | ✓ | ✓ |
| Mechanische rem | - | - | - | - | - | ✓ | ✓ |
| Gewicht | 6,3 kg | 6,5 kg | 6,7 kg | 6,9 kg | 6,4 kg | 6,3 - 8,5 kg | 6,3 - 8,5 kg |
| Prijs in € | excl. btw | | | | | | |
| | incl. btw | | | | | | |

STEMPELSLIJERS



GS5000



GD0811C



GD0810C



GD0800C



GD0603



| | GD0600 | GD0603 | GD0800C | GD0810C | GD0801C | GD0811C | GS5000 |
|-------------------------|--------------|--------------|-------------------|------------------|-------------------|------------------|-------------|
| Nominaal vermogen | 400 W | 240 W | 750 W | 750 W | 750 W | 750 W | 750 W |
| Toerental | 25000 t.p.m. | 28000 t.p.m. | 7000-28000 t.p.m. | 1800-7000 t.p.m. | 7000-28000 t.p.m. | 1800-7000 t.p.m. | 5600 t.p.m. |
| Ø spantang - bereik | 6 mm | 6 mm | 6-8 mm | 6-8 mm | 6-8 mm | 6-8 mm | 20 mm |
| Ø spantang - inbegrepen | 6 mm | 6 mm | 6 mm | 6 mm | 6 mm | 6 mm | 20 mm |
| Lepelschakelaar | ✓ | - | - | - | ✓ | ✓ | - |
| Dodemans | - | - | - | - | ✓ | ✓ | ✓ |
| Gewicht | 1,7 kg | 0,97 kg | 1,7 kg | 1,7 kg | 1,7 kg | 2,0 kg | 5,0 kg |
| Prijs in € | excl. btw | | | | | | |
| | incl. btw | | | | | | |

COMBOPACK SLIJERS



9558HNRG

GA9060

125 mm

230 mm

DK0047GX1

| | | |
|-----------------------|---------------|--|
| Haakse slijper 230 mm | GA9060 | |
| Haakse slijper 125 mm | 9558HNRG | |
| Diamantschijf | 2 x Diamak DS | |
| Synthetische koffer | ✓ | |
| Prijs in € | excl. btw | |
| | incl. btw | |

COMBOPACK SCHUURMACHINE + STOFZUIGER



DK6525

| | | |
|---------------|-----------|--|
| Schuurmachine | BO6050J | |
| Stofzuiger | VC2510LX1 | |
| Prijs in € | excl. btw | |
| | incl. btw | |

METAALAFKORTMACHINES

LC1230N

- Inclusief HM zaagblad
- verstekhoek instelbaar op 45°



LW1400X



LC1230N

LW1400X LC1230N

| | | |
|-------------------|-----------------|-------------|
| Nominaal vermogen | 2200 W | 1750 W |
| Type schijf | doorslijpschijf | zaagblad |
| Toerental | 3800 t.p.m. | 1300 t.p.m. |
| Zaagdiepte (90°) | 115 mm | 100 mm |
| Ø Zaagblad | 355 mm | 305 mm |
| Gewicht | 17,2 kg | 19,3 kg |
| Prijs in € | excl. btw | |
| | incl. btw | |

BETONSCHAVEN



PC5001C
Geleverd met
komschijf
B-12289



PC50001C

PC5010C

PC5010C PC5001C

| | | |
|-------------------|-----------|--------|
| Nominaal vermogen | 1400 W | 1400 W |
| Ø schijf | 125 mm | 125 mm |
| Gewicht | 2,5 kg | 5,1 kg |
| Prijs in € | excl. btw | |
| | incl. btw | |

PC5010C:
Instelbaar toerental

MUURFREZEN



SG150



SG181

SG1251J SG150 SG181

| | | | |
|-------------------|-----------|---------|---------|
| Nominaal vermogen | 1400 W | 1800 W | 2150 W |
| Max. slijpdiepte | 30 mm | 45 mm | 60 mm |
| Sleufbreedte | 6-30 mm | 7-35 mm | 7-43 mm |
| Ø schijf | 125 mm | 150 mm | 180 mm |
| Gewicht | 4,4 kg | 5,7 kg | 6 kg |
| Prijs in € | excl. btw | | |
| | incl. btw | | |

DIAMANTZAAG



4114S

| | |
|-------------------|-----------|
| Nominaal vermogen | 2400 W |
| Max. slijpdiepte | 125 mm |
| Ø schijf | 350 mm |
| Ø asgat | 25,4 mm |
| Gewicht | 10,8 kg |
| Prijs in € | excl. btw |
| | incl. btw |

DIAMANTZAAG



4100KB

| | |
|-------------------|-----------|
| Nominaal vermogen | 1400 W |
| Zaagdiepte (90°) | 40 mm |
| Ø Zaagblad | 125 mm |
| Gewicht | 3,0 kg |
| Prijs in € | excl. btw |
| | incl. btw |

SLAGMOERSLEUTELS



TW0200J
TW0350J
6906J

TW0350J

| | TW0200J | TW0350J | 6906J | TW1000 |
|-------------------|---------------|---------------|---------------|-------------|
| Nominaal vermogen | 380 W | 400 W | 650 W | 1300 W |
| Max. koppel | 200 Nm | 350 Nm | 588 Nm | 1000 Nm |
| Bitopname | 1/2" vierkant | 1/2" vierkant | 3/4" vierkant | 1" vierkant |
| Gewicht | 2,2 kg | 3 kg | 5,6 kg | 8,6 kg |
| Prijs in € | excl. btw | | | |
| | incl. btw | | | |

HETELUCHTPISTOLEN



HG6531CK



HG5030K

| | HG5030K | HG6031VK | HG6531CK |
|---------------------|-----------------|-----------------|---------------------------------|
| Vermogen | 1600 W | 1800 W | 2000 W |
| Temperatuurbereik | 350-500 °C | 50-600 °C | 50-650 °C |
| Temperatuurstelling | 2 niveaus | 9 niveaus | Elektronisch in stappen van 5°C |
| Debiet | 300 / 500 l/min | 250 / 500 l/min | 200 / 550 l/min |
| Gewicht | 0,56 kg | 0,67 kg | 0,71 kg |
| Prijs in € | excl. btw | | |
| | incl. btw | | |

KNABBELSCHAREN



JN3201J

| | JN1601 | JN3201J |
|-------------------|-----------|---------|
| Nominaal vermogen | 550 W | 710 W |
| Max. dikte staal | 1,6 mm | 3,2 mm |
| Gewicht | 1,6 kg | 3,4 kg |
| Prijs in € | excl. btw | |
| | incl. btw | |

PLAATSCHAREN



JS1602J

| | JS1601J | JS1602J | JS3201J |
|-----------------------|-----------|-----------|-----------|
| Nominaal vermogen | 380 W | 380 W | 710 W |
| Aantal zaagbewegingen | 4500 /min | 4000 /min | 1600 /min |
| Max. dikte staal | 1,6 mm | 1,6 mm | 3,2 mm |
| Gewicht | 1,4 kg | 1,6 kg | 3,4 kg |
| Prijs in € | excl. btw | | |
| | incl. btw | | |

METAALCIRKELZAAG



4131

| | |
|-------------------|-------------|
| Nominaal vermogen | 1100 W |
| Toerental | 3500 t.p.m. |
| Zaagdiepte (90°) | 63 mm |
| Ø Zaagblad | 185 mm |
| Gewicht | 5,1 kg |
| Prijs in € | excl. btw |
| | incl. btw |

GROEFFREES



CA5000XJ

| | |
|-------------------|------------------|
| Nominaal vermogen | 1300 W |
| Toerental | 2200-6400 t.p.m. |
| Ø Zaagblad | 118 mm |
| Gewicht | 5,1 kg |
| Prijs in € | excl. btw |
| | incl. btw |

SLIJPMOLENS



GB801

| | GB602W | GB801 |
|-------------------|-------------|-------------|
| Nominaal vermogen | 250 W | 550 W |
| Toerental | 2850 t.p.m. | 2850 t.p.m. |
| Ø Slijpsteen | 150 mm | 205 mm |
| Gewicht | 9 kg | 19,8 kg |
| Prijs in € | excl. btw | |
| | incl. btw | |

LINTZAAGMACHINE

B-42581
Schuurbanden 20 x 2240 mm
Rood • Korrel 80

B-42597
Schuurbanden 20 x 2240 mm
Rood • Korrel 120

JM21000330
Adapterset voor schuurbanden



LB1200F

| | |
|-------------------|-----------|
| Nominaal vermogen | 900 W |
| Breedte zaaglint | 6-16 mm |
| Gewicht | 81,2 kg |
| Prijs in € | excl. btw |
| | incl. btw |

RECIPROZAGEN



JR3070CT

| | | JR3051TK | JR3061T | JR3070CT |
|-----------------------|-----------|-----------------------|-----------------------|----------------------|
| Nominaal vermogen | | 1200 W | 1250 W | 1510 W |
| Aantal zaagbewegingen | | 0-3000 /min | 0-2800 /min | 0-2800 /min |
| AVT | | - | - | ✓ |
| Pendelinstelling | | - | - | ✓ |
| Slaglengte | | 30 mm | 32 mm | 32 mm |
| Vibratieniveau | | 19,5 m/s ² | 23,5 m/s ² | 8,5 m/s ² |
| Gewicht | | 3,2 kg | 4,4 kg | 4,4 kg |
| Prijs in € | excl. btw | | | |
| | incl. btw | | | |

LAMELLENFREES



Aanslagplaat met tandheugelverstelling voor een snelle en precieze aanpassing aan de materiaaldikte.

Revolver diepte-instelling met 6 preselecties voor een snelle afstelling.



Kantelbare voetplaat met handige vergrendelingshendel en automatische stops op 0°, 45° en 90°.

| | | PJ7000J |
|-------------------|-----------|--------------|
| Nominaal vermogen | | 700 W |
| Toerental | | 11000 t.p.m. |
| Ø zaagblad | | 100 mm |
| Asgat | | 22 mm |
| Gewicht | | 2,5 kg |
| Prijs in € | excl. btw | |
| | incl. btw | |

MULTITOOL



INCLUSIEF:
Set van 9 accessoires,
30 schuurvellen en 1 afzuigset



GEREEDSCHAPSLOZE
ACCESSOIREWISSEL

| | | TM3010CX3J |
|----------------------|-----------|----------------|
| Nominaal vermogen | | 320 W |
| Oscillatiefrequentie | | 6000-20000/min |
| Oscillatiehoek | | 3,2° |
| Gewicht | | 1,6 kg |
| Prijs in € | excl. btw | |
| | incl. btw | |

VANDIKTEBANK



| | | 2012NB |
|---------------------|-----------|-------------|
| Nominaal vermogen | | 1650 W |
| Toerental | | 8500 t.p.m. |
| Breedte | | 304 mm |
| Max. doorlaathoogte | | 155 mm |
| Max. spaanafname | | 3 mm |
| Gewicht | | 28,1 kg |
| Prijs in € | excl. btw | |
| | incl. btw | |

KETTINGFREZEN

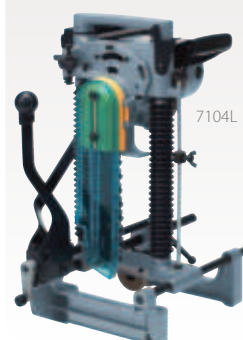

| | | 7104L | 7104L-30 |
|--------------------------|-----------|-------------|-------------|
| Nominaal vermogen | | 1140 W | 1140 W |
| Toerental | | 3200 t.p.m. | 3200 t.p.m. |
| Kettingsnelheid onbelast | | 5 m/s | 5 m/s |
| Ketting | | 16,5 mm | 30 mm |
| Gatbreedte | | 16,5-30 mm | 30-45 mm |
| Gatlengte | | 54-130 mm | 54-130 mm |
| Gewicht | | 17,3 kg | 17,3 kg |
| Prijs in € | excl. btw | | |
| | incl. btw | | |

BOVENFREZEN



RP1111CJ



RP2302FC07

RP2302FC07: Inclusief langsgleider met fijnafstelling

| | RP0900J | RP1111CJ | RP1802FX02 | RP2302FC07 |
|-------------------------|--------------|---------------------|--------------|-------------------|
| Nominaal vermogen | 900 W | 1100 W | 1850 W | 2300 W |
| Toerental | 27000 t.p.m. | 8000 - 27500 t.p.m. | 23000 t.p.m. | 9000-22000 t.p.m. |
| Max. induikdiepte | 35 mm | 57 mm | 70 mm | 70 mm |
| Ø Spantang - bereik | 6-8 mm | 6-8 mm | 6-12 mm | 6-12 mm |
| Ø Spantang - inbegrepen | 8 mm | 8 mm | 6, 8, 12 mm | 6, 8, 12 mm |
| Verpakking | Makpac | Makpac | Karton | Makpac |
| Gewicht | 2,7 kg | 3,3 kg | 6,2 kg | 6,1 kg |
| Prijs in € | excl. btw | | | |
| | incl. btw | | | |

KANTENFREZEN



3711



3712

3712: Inclusief kantelbare zool

| | 3711 | 3712 |
|-------------------|--------------|--------------|
| Nominaal vermogen | 530 W | 530 W |
| Toerental | 32000 t.p.m. | 32000 t.p.m. |
| Max. induikdiepte | 42 mm | 42 mm |
| Spantang | 6 mm | 6 mm |
| Gewicht | 1,5 kg | 1,7 kg |
| Prijs in € | excl. btw | |
| | incl. btw | |

BOVEN- EN KANTENFREES



4 MACHINES IN 1

- Rechte kantenfrees
- Verstelbare kantenfrees
- Kantenfrees met verschoven spindel
- Bovenfrees

Rechte kantenfrees
Regelbare freesdiepte van 0 tot 40 mm

Verstelbare kantenfrees
Hoekinstelling tussen -30° en 45°

Kantenfrees met verschoven spindel om zo dicht mogelijk tegen een obstakel te werken

Bovenfrees
Diepteregeling per 1/10 van een mm van 0 tot 35 mm

RT0702CX3J

| | |
|-------------------------|--------------------|
| Nominaal vermogen | 710 W |
| Toerental | 10000-30000 t.p.m. |
| Max. induikdiepte | 35 mm |
| Ø Spantang - bereik | 6 - 8 mm |
| Ø Spantang - inbegrepen | 6 mm, 8 mm |
| Gewicht | 1,8 kg |
| Prijs in € | excl. btw |
| | incl. btw |

SCHAVEN



KP0810CJ

| | KP0800J | KP0810J | KP0810CJ | 1100 | 1911BJ | 1806B | KP312S |
|-------------------|--------------|--------------|--------------|--------------|--------------|--------------|--------------|
| Nominaal vermogen | 620 W | 850 W | 1050 W | 950 W | 900 W | 1200 W | 2200 W |
| Toerental | 17000 t.p.m. | 16000 t.p.m. | 12000 t.p.m. | 16000 t.p.m. | 16000 t.p.m. | 18000 t.p.m. | 12000 t.p.m. |
| Breedte | 82 mm | 82 mm | 82 mm | 82 mm | 110 mm | 170 mm | 312 mm |
| Max. spaanafname | 2,5 mm | 4 mm | 4 mm | 3 mm | 2 mm | 2 mm | 3,5 mm |
| Gewicht | 2,6 kg | 3,3 kg | 3,4 kg | 5,1 kg | 4,3 kg | 9,0 kg | 18,4 kg |
| Prijs in € | excl. btw | | | | | | |
| | incl. btw | | | | | | |

DECOUPEERZAGEN



4350FCTJ



4351FCTJ



JV0600J



4329K



| | 4326 | 4329K | JV0600J | 4350FCTJ | 4351FCTJ |
|-----------------------|-----------|---------------|---------------|---------------|---------------|
| Nominaal vermogen | 450 W | 450 W | 650 W | 720 W | 720 W |
| Aantal zaagbewegingen | 3100 /min | 500-3100 /min | 500-3100 /min | 800-2800 /min | 800-2800 /min |
| Max. capaciteit hout | 65 mm | 65 mm | 90 mm | 135 mm | 135 mm |
| Makpac | - | - | ✓ | ✓ | ✓ |
| Gewicht | 1,8 kg | 1,9 kg | 2,4 kg | 2,6 kg | 2,5 kg |
| Prijs in € | excl. btw | | | | |
| | incl. btw | | | | |

COMBOPACK



SP6000J



M-Force



4351FCTJ

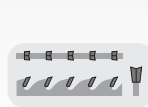

MEU029J

| | |
|----------------------|-----------|
| Invalcirkelzaag | SP6000J |
| Decoupeerzaag | 4351FCTJ |
| Geleiderail 1400 mm | 194368-5 |
| Extra cirkelzaagblad | B-32007 |
| Decoupeerzaagbladen | 5 |
| Draagtas | E-05664 |
| Prijs in € | excl. btw |
| | incl. btw |

INVALCIRKELZAAG



Bij model SP6000J1
2 x geleiderail 1,4 m
+ koppelstrips



SP6000J1

| | |
|-----------------------|-----------|
| Nominaal vermogen | 1300 W |
| Zaagdiepte (90°) | 57 mm |
| Zaagdiepte (45°) | 40 mm |
| Max. zaagdiepte (48°) | 38 mm |
| Ø Zaagblad | 165 mm |
| Gewicht | 4,4 kg |
| Prijs in € | excl. btw |
| | incl. btw |

CIRKELZAGEN



5008MGJX



Zaagblad
gratis bij 5008MGJX



HS7101JX



2 x zaagblad 12 tanden
bij HS7101JX
2 x zaagblad 16 tanden bij
5903RKX1



HS0600



5143R

| | HS6601 | HS6101J | HS7601J | HS7101JX | 5008MGJX | 5903RKX1 | HS0600 | 5143R |
|-------------------|-----------|---------|---------|----------|----------|----------|--------|---------|
| Nominaal vermogen | 1050 W | 1100 W | 1200 W | 1400 W | 1800 W | 2000 W | 2000 W | 2200 W |
| Zaagdiepte (90°) | 54,5 mm | 54,5 mm | 66 mm | 67 mm | 75,5 mm | 85 mm | 101 mm | 130 mm |
| Ø Zaagblad | 165 mm | 165 mm | 190 mm | 190 mm | 210 mm | 235 mm | 270 mm | 355 mm |
| Gewicht | 3,7 kg | 3,7 kg | 4,0 kg | 4,0 kg | 5,1 kg | 7,2 kg | 6,9 kg | 14,0 kg |
| Prijs in € | excl. btw | | | | | | | |
| | incl. btw | | | | | | | |

TAFEL-, AFKORT- EN VERSTEKZAGEN



LF1000



LF1000



LH1201FL

SNELLE OMBOUW
VAN TAFEL- NAAR
AFKORTZAAGFUNCTIE

| Verstekhoek | LH1040 | LH2101 | LF1000 |
|-------------|------------|---------------------------|----------------------------|
| | 90° | 91 x 95 mm 69 x 130 mm | 95 x 155 mm 62 x 200 mm |
| 45° | 69 x 85 mm | 62 x 125 mm | 50 x 150 mm |

| | | LH1040F | LH1201FL | LF1000 |
|-------------------|-----------|---------|----------|--------|
| Nominaal vermogen | | 1650 W | 1650 W | 1650 W |
| Ø Zaagblad | | 260 mm | 305 mm | 260 mm |
| Gewicht | | 14,3 kg | 20,7 kg | 36 kg |
| Prijs in € | excl. btw | | | |
| | incl. btw | | | |

AFKORT-VERSTEKZAAG



Kantelbaar naar links tot 45°

| | | LS1040N |
|---------------------|-----------|------------|
| Nominaal vermogen | | 1650 W |
| Ø Zaagblad | | 260 mm |
| Max. zaagdiepte 0° | | 91 x 95 mm |
| Max. zaagdiepte 45° | | 91 x 67 mm |
| Gewicht | | 12,4 kg |
| Prijs in € | excl. btw | |
| | incl. btw | |

BOUWCIRKELZAAG



| | | 2712 |
|---------------------|-----------|---------|
| Nominaal vermogen | | 2000 W |
| Ø Zaagblad | | 315 mm |
| Max. zaagdiepte 0° | | 85 mm |
| Max. zaagdiepte 45° | | 58 mm |
| Gewicht | | 52,9 kg |
| Prijs in € | excl. btw | |
| | incl. btw | |

TAFELZAAG MET ONDERSTEL



| | | 2704NX1 |
|-------------------|-----------|---------|
| Nominaal vermogen | | 1650 W |
| Ø Zaagblad | | 260 mm |
| Gewicht | | 34,9 kg |
| Prijs in € | excl. btw | |
| | incl. btw | |

TAFELZAAG



Optioneel accessoire:
JM27000300
Onderstel MLT100N

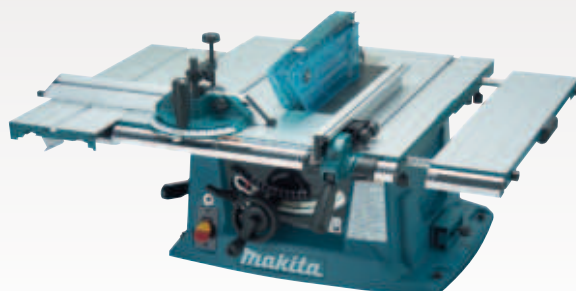

| | | MLT100N |
|-------------------|-----------|---------|
| Nominaal vermogen | | 1500 W |
| Ø Zaagblad | | 260 mm |
| Gewicht | | 34,7 kg |
| Prijs in € | excl. btw | |
| | incl. btw | |

TELESCOPISCHE AFKORT-VERSTEKZAGEN

PROMO

Gratis onderstel DEBWST06 t.w.v. bij LS1019L/LS1219L

| Model | DEBWST06 - Onderstel |
|--------|---|
| LS1019 | ✓  |
| LS1219 | ✓  |

Max. lengte: 2550 mm

Nieuwe bevestigingsklemmen voor het bevestigen van verstekzagen op onderstellen DEBWST06 en DEAWST07



JM00000219

LS0816F

- Radiaal afkortzaag met maximale werkhoogte van 65 mm
- Nauwkeurige weergave van zaaglijn door gebruik van schaduwstelsysteem
- Voorzien van ingebouwde materiaal-stop en zijdelingse steunen

LS1110F

- Radiaal afkortzaag met maximale werkhoogte van 91 mm
- Nauwkeurige weergave van zaaglijn door gebruik van schaduwstelsysteem
- Voorzien van ingebouwde materiaal-stop en zijdelingse steunen

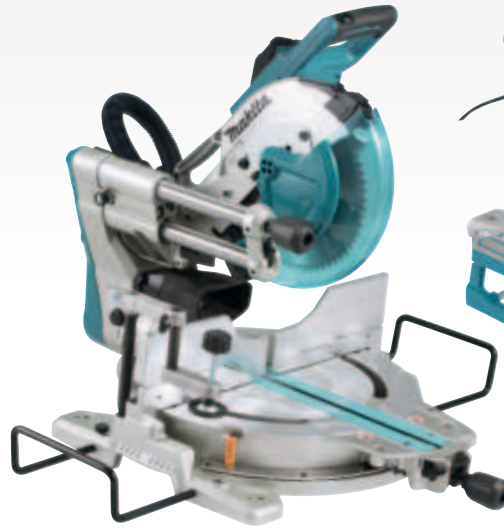

LS1019L



LS0816F

| Verstekhoek | LS1219L - Snijhoek | | |
|-------------|--------------------|------------|------------|
| | 45° links | 0° | 45° rechts |
| 0° | 71x363 mm | 107x363 mm | 54x363 mm |
| 45° L EN R | 71x255 mm | 107x255 mm | 54x255 mm |
| 60° L EN R | - | 107x178 mm | - |
| PLINTEN | - | 171 mm | - |

| Verstekhoek | LS1019L - Snijhoek | | |
|-------------|--------------------|-----------|------------|
| | 45° links | 0° | 45° rechts |
| 0° | 61x279 mm | 91x279 mm | 43x279 mm |
| 45° L EN R | 61x197 mm | 91x197 mm | 43x197 mm |
| 60° L EN R | - | 91x139 mm | - |
| PLINTEN | - | 133 mm | - |

| Verstekhoek | LS0815FL - Snijhoek | | |
|-------------|---------------------|-----------|-----------|
| | 45° links | 0° | 5° rechts |
| 0° | 50x305 mm | 65x305 mm | 60x305 mm |
| 45° L EN R | 50x215 mm | 65x215 mm | - |
| 60° R | - | 65x150 mm | - |

| Verstekhoek | LS1018LN - Snijhoek | | |
|-------------|---------------------|-----------|------------|
| | 45° links | 90° | 45° rechts |
| 0° | 50x310 mm | 91x310 mm | 31x310 mm |
| 45° L EN R | 50x220 mm | 91x220 mm | 31x220 mm |
| 60° R | - | 91x153 mm | - |

| Verstekhoek | LS0714FLB - Snijhoek | | |
|-------------|----------------------|-----------|------------|
| | 45° links | 90° | 45° rechts |
| 0° | 40x300 mm | 52x300 mm | 40x300 mm |
| 45° L EN R | 40x212 mm | 52x212 mm | - |
| 57° R | - | 52x163 mm | - |

| | LS0816F | LS0815FLN | LS1110F | LS1018LN | LS0714LN | LS1019L | LS1219L |
|-------------------|-----------|-----------|---------|----------|----------|---------|---------|
| Nominaal vermogen | 1200 W | 1400 W | 1450 W | 1430 W | 1010 W | 1510 W | 1800 W |
| Ø zaagblad | 216 mm | 216 mm | 260 mm | 260 mm | 190 mm | 260 mm | 305 mm |
| DXT | - | - | - | - | - | ✓ | ✓ |
| Gewicht | 13,9 | 14,2 kg | 16,4 kg | 19,9 kg | 13,4 kg | 26,3 kg | 29,5 kg |
| Prijs in € | excl. btw | | | | | | |
| | incl. btw | | | | | | |

DXT
Deep and Exact Cutting Technology

De gepatenteerde constructie met driefoudige tandwieloverbrenging en uitsparing achter de flens laat toe om een groter deel van het zaagblad te benutten. Daardoor kunnen ook hoge plinten verticaal of in verstek afgekort worden.



ONDERSTEL AFKORT-VERSTEKZAGEN

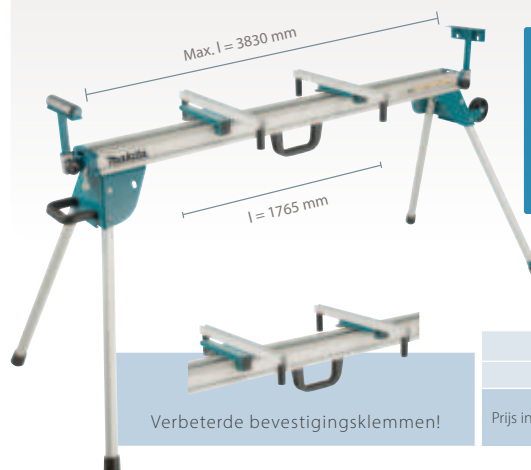

Verbeterde bevestigingsklemmen!

- Ideaal voor het zagen van lange materialen
- Vernieuwde bevestigingsklemmen met een veilig en handig kliksysteem om moeiteloos verstekzagen te installeren en te demonteren.
- Gemakkelijk te transporteren

| DEAWST07 | |
|-------------|---------------------------------|
| Afmetingen | 1765 (l) x 750 (b) x 850 (h) mm |
| Max. lengte | 3830 mm |
| Prijs in € | excl. btw |
| | incl. btw |

HANDPALMVLAKSCHUURMACHINES



BO4565K



| | BO4556K | BO4555K | BO4558 | BO4565K |
|-------------------------|--------------|---------------|--------------|-------------------------|
| Nominaal vermogen | 200 W | 200 W | 200 W | 200 W |
| Afmetingen schuurvoet | 112 x 102 mm | 112 x 102 mm | 112 x 102 mm | 112 x 190 mm |
| Bevestiging | Klem | Velcro & klem | Klem | Velcro Driehoekspunt |
| Materiaal schuurvoet | Kunststof | Kunststof | Aluminium | Kunststof |
| Aantal schuurbewegingen | 14000/min | 14000/min | 14000/min | 14000/min |
| Schuuruitslag | 1,5 mm | 1,5 mm | 1,5 mm | 1,5 mm |
| Gewicht | 1,1 kg | 1,1 kg | 1,2 kg | 1,2 kg |
| Prijs in € | excl. btw | | | |
| | incl. btw | | | |



VLAKSCHUURMACHINES MET VARIABLE SNELHEID



BO3711



| | BO3711 | BO4900VJ |
|-------------------------|----------------|----------------|
| Nominaal vermogen | 190 W | 330 W |
| Afmetingen schuurvoet | 93 x 185 mm | 115 x 232 mm |
| Aantal schuurbewegingen | 4000-11000/min | 4000-10000/min |
| Schuuruitslag | 2,0 mm | 2,6 mm |
| Gewicht | 1,6 kg | 2,7 kg |
| Prijs in € | excl. btw | |
| | incl. btw | |

BANDSCHUURMACHINES



9403J:
Zeer krachtig,
ideaal voor intensief
schuurwerk

9911J
9403J



9403J



9911J



9032



| | 9911J | 9924DB | 9903J | 9031 | 9032 | 9920J | 9404J | 9403J |
|-------------------|--------------|-------------|---------------|----------------|----------------|---------------|---------------|--------------|
| Nominaal vermogen | 650 W | 850 W | 1010 W | 550 W | 500 W | 1010 W | 1010 W | 1200 W |
| Bandsnelheid | 75-270 m/min | 400 m/min | 210-440 m/min | 200-1000 m/min | 300-1700 m/min | 210-440 m/min | 210-440 m/min | 500 m/min |
| Schuurband | 75 x 457 mm | 75 x 610 mm | 75 x 533 mm | 30 x 533 mm | 9 x 533 mm | 75 x 610 mm | 100 x 610 mm | 100 x 610 mm |
| Gewicht | 2,7 kg | 4,8 kg | 4,3 kg | 2,1 kg | 1,6 kg | 4,5 kg | 4,8 kg | 5,7 kg |
| Prijs in € | excl. btw | | | | | | | |
| | incl. btw | | | | | | | |

EXCENTRISCHE SCHUURMACHINES



BO5031K



BO5041K



BO6050J



| | BO5031K | BO5041K | BO6030JX | BO6050J |
|-------------------------|----------------|----------------|----------------|----------------|
| Nominaal vermogen | 300 W | 300 W | 310 W | 750 W |
| Aantal schuurbewegingen | 8000-24000/min | 8000-24000/min | 8000-20000/min | 3200-13600/min |
| Schuuruitslag | 2,8 mm | 2,8 mm | 3 mm | 5,5 mm |
| Ø Schuurvoet | 123 mm | 123 mm | 147 mm | 147 mm |
| Gewicht | 1,3 kg | 1,4 kg | 2,4 kg | 2,6 kg |
| Prijs in € | excl. btw | | | |
| | incl. btw | | | |

HAAKSE SCHUURMACHINE



SA7000C

SA7000C

| | |
|--------------------|---------------|
| Nominaal vermogen | 1600 W |
| Toerental onbelast | 0-4000 t.p.m. |
| Ø schijf | 180 mm |
| Gewicht | 3,4 kg |
| Prijs in € | excl. btw |
| | incl. btw |

EXCENTRISCHE POLIJSTMACHINE



PO6000C

PO6000C

| | |
|-------------------------|---------------|
| Nominaal vermogen | 890 W |
| Aantal schuurbewegingen | 0-13600 /min. |
| Ø schijf | 150 mm |
| Schuuruitslag | 5,5 mm |
| Gewicht | 2,7 kg |
| Prijs in € | excl. btw |
| | incl. btw |

SCHUUR- EN POETSMACHINE



9237CB

9237CB

| | |
|-------------------|---------------|
| Nominaal vermogen | 1200 W |
| Toerental | 0-3200 t.p.m. |
| Ø schijf | 180 mm |
| Gewicht | 3,4 kg |
| Prijs in € | excl. btw |
| | incl. btw |

BORSTELSCUURMACHINE



9741J

9741J

| | |
|-------------------|-------------|
| Nominaal vermogen | 860 W |
| Toerental | 3500 t.p.m. |
| Gewicht | 4,2 kg |
| Prijs in € | excl. btw |
| | incl. btw |

GASNAGELPISTOOL VOOR
AFWERKNAGELS 16 GA



GF600SE

| | |
|---------------------|----------------|
| Accu | 7,2 V / 1,0 Ah |
| Gemiddelde laadtijd | 30 min |
| Doorsnede nagel | 1,6 mm |
| Lengte nagel | 15-64 mm |
| Gewicht | 2,2 kg |
| Prijs in € | excl. btw |
| | incl. btw |

GASNAGELPISTOOL
VOOR BETON



GN420CSE

| | |
|---------------------|----------------|
| Accu | 7,2 V / 1,0 Ah |
| Gemiddelde laadtijd | 30 min |
| Doorsnede nagel | 2,6-3,0 mm |
| Lengte nagel | 15-40 mm |
| Gewicht | 3,5 kg |
| Prijs in € | excl. btw |
| | incl. btw |

GASNAGELPISTOOL VOOR
HOUT



GN900SE

| | |
|---------------------|----------------|
| Accu | 7,2 V / 1,0 Ah |
| Gemiddelde laadtijd | 30 min |
| Doorsnede nagel | 2,9-3,3 mm |
| Lengte nagel | 50-90 mm |
| Gewicht | 3,3 kg |
| Prijs in € | excl. btw |
| | incl. btw |

COMPRESSOR 230V



MAC210Q

- Compacte 1 pk luchtcompressor, ideaal voor gebruik in combinatie met kleine persluchtgereedschappen zoals nagelaars
- Laag toerental: vermindert het geluidsniveau en verlengt de levensduur van de pomp
- Compacte rolkooiconstructie, draagbaar
- Olivrijne pomp met twee cilinders
- Twee grote manometers

MAC210Q

| | |
|-------------|--------------------|
| Voeding | 230 V AC |
| Luchtdebiet | 48 l/min @ 6,2 bar |
| Werkdruk | 0 - 9,3 bar |
| Tankinhoud | 7,6 l |
| Geluidsdruk | 60 dB (A) |
| Gewicht | 22 kg |
| Prijs in € | excl. btw |
| | incl. btw |

PNEUMATISCH CONSTRUCTIE-
NAGELPISTOOL 21°



AN924

| | |
|-----------------|-------------|
| Werkdruk | 4,9-8,3 bar |
| Doorsnede nagel | 3,76 mm |
| Lengte nagel | 50-90 mm |
| Gewicht | 3,8 kg |
| Prijs in € | excl. btw |
| | incl. btw |

MINIBRADPISTOOL 18 GA



AF506

| | |
|-----------------|-------------|
| Werkdruk | 4,8-8,3 bar |
| Draadkaliber | 18 Ga |
| Ø Nagelkop | 2,0 mm |
| Doorsnede nagel | 1,2 mm |
| Lengte nagel | 15-50 mm |
| Gewicht | 1,4 kg |
| Prijs in € | excl. btw |
| | incl. btw |

BRADPISTOOL 16 GA



AF601

| | |
|-----------------|----------------|
| Werkdruk | 0,49 - 8,3 bar |
| Draadkaliber | 16 Ga |
| Doorsnede nagel | 1,6 mm |
| Lengte nagel | 25 - 64 mm |
| Gewicht | 1,7 kg |
| Prijs in € | excl. btw |
| | incl. btw |

PNEUMATISCH CONSTRUCTIE-
NAGELPISTOOL 34°



AN943K

| | |
|-----------------|-------------|
| Werkdruk | 4,5-8,5 bar |
| Ø Nagelkop | 7,0 mm |
| Doorsnede nagel | 2,9-3,3 mm |
| Lengte nagel | 50-90 mm |
| Gewicht | 3,9 kg |
| Prijs in € | excl. btw |
| | incl. btw |

LASERAFSTANDSMETER



LD080PI



LD030P



| | LD030P | LD050P | LD080PI |
|------------|-----------|--------|---------|
| Bereik | 30 m | 50 m | 80 m |
| Gewicht | 0,1 kg | 0,1 kg | 0,1 kg |
| Prijs in € | excl. btw | | |
| | incl. btw | | |

ROTARENDE LASER



PROMO
gratis statief 2,7 m
t.w.v.



P-81315

Inclusief ontvanger, bril voor laser, afstandsbediening en wandbevestiging

| | | SKR200Z |
|-----------------|-----------|--------------|
| Rotatiesnelheid | | 0-600 t.p.m. |
| Bereik | | 100 m |
| Gewicht | | 1,6 kg |
| Prijs in € | excl. btw | |
| | incl. btw | |

ACCU MUURSCANNER



De DWD181 gebruikt radartechnologie om nauwkeurig metaal, hout, elektrische bekabeling en andere objecten in wanden en vloeren te detecteren

4,1 inch kleurscherm

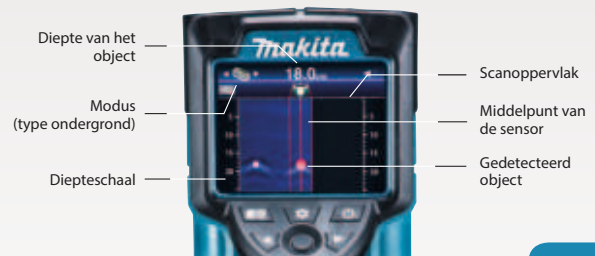

| | | DWD181ZJ |
|---|-----------|-------------|
| Spanning | | 14,4V/18 V |
| Max. detectiediepte | | 25 - 180 mm |
| Tolerantie detectiediepte | | ± 5 mm |
| Minimum detecteerbare afstand tussen objecten | | 40 mm |
| Bijgeleverde lader/accu | | - |
| Gewicht zonder accu | | 1,0 kg |
| Prijs in € | excl. btw | |
| | incl. btw | |

KRUISLIJN- EN LIJNLASERS (CXT)

SK105DZ, SK105GDZ & SK106GDZ
PROMO
Incl. BL1021B + DC105B



SK105DZ



SK106GDZ

Kruislijn

SK105GD



SK105D



Kruislijn + 4 punten

SK106GD

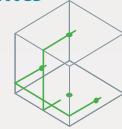

SK105DZ SK105GDZ SK106GDZ

| | SK105DZ | SK105GDZ | SK106GDZ |
|---------------------|----------------------|----------------------|----------------------|
| Kleur | Rood | Groen | Groen |
| Projecties | 1 H - 1 V | 1 H - 1 V | 1 H - 1 V + 4 punten |
| Nauwkeurigheid | +3 mm / 10 m | +3 mm / 10 m | +3 mm / 10 m |
| Bereik | 25 m | 25 m | 25 m |
| Bijgeleverde accu's | 1 x BL1021B + DC105B | 1 x BL1021B + DC105B | 1 x BL1021B + DC105B |
| Gewicht | 0,67 kg | 0,67 kg | 0,69 kg |
| Prijs in € | excl. btw | | |
| | incl. btw | | |

SK10GD/SK20GD/SK40GD

- Groene laser met hoge helderheid
- Uiterst nauwkeurig
- Stevige constructie, beschermingsklasse IP54

Horizontaal / 4-Verticale lijnen

Horizontaal / 2-Verticale lijnen

Kruislijn + Punt

SK40GD

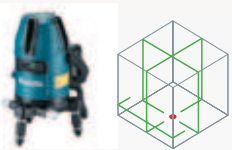

SK20GD



SK10GD

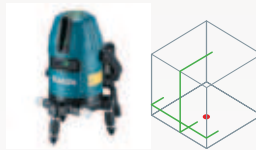

SK10GDZ, SK20GDZ, SK40GDZ, SK209GDZ & SK312GDZ
PROMO
gratis powerpack 197658-5



SK209GDZ



SK312GDZ

1 horizontale + 2 verticale lijnen

SK209GD



1 horizontale + 3 verticale lijnen

SK312GD



SK10GDZ SK20GDZ SK40GDZ SK209GDZ SK312GDZ

| | SK10GDZ | SK20GDZ | SK40GDZ | SK209GDZ | SK312GDZ |
|---------------------|---------------------|---------------------|---------------------|---------------------|---------------------|
| Kleur | Groen | Groen | Groen | Groen | Groen |
| Projecties | 1 H - 1 V | 1 H - 2 V | 1 H - 4 V | 1 H - 2 V | 1 H - 3 V |
| | + loodpunt | + loodpunt | + loodpunt | + loodpunt | + loodpunt |
| Nauwkeurigheid | ±1 mm/10m | ±1 mm/10m | ±1 mm/10m | +1 mm/10m | +1 mm/10m |
| Bereik | - | - | - | - | - |
| Bijgeleverde accu's | 2x BL1021B + DC105B | 2x BL1021B + DC105B | 2x BL1021B + DC105B | 2x BL1021B + DC105B | 2x BL1021B + DC105B |
| Gewicht | 1,4 - 1,6 kg | 1,4 - 1,6 kg | 1,4 - 1,6 kg | 1,5 - 1,6 kg | 1,5 - 1,6 kg |
| Prijs in € | excl. btw | | | | |
| | incl. btw | | | | |

KRUISLIJN- EN LIJNLASERS (CXT)

SK700DZ/SK700GDZ:

- 3x 360° laser (3 stralen: 1 horizontaal 360° + 2 verticaal 360°).
- Zeer hoge nauwkeurigheid.
- Blokkeerstand voor projectie van schuine lijnen en voor transport.
- Zeer grote autonomie dankzij de 12Vmax CXT batterij.
- IP54 bescherming.



Hoge intensiteit
De SK700GDZ met krachtige groene laser biedt een uitstekende zichtbaarheid, ook in een omgeving met invallend daglicht.



Via een sneldraaiende conische spiegel wordt de laserstraal over 360° geprojecteerd.

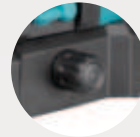

Fijnafstelling: Via een knop op de basis kan de unit zeer precies over een bereik van 10° gedraaid worden. De bevestiging is excentrisch zodat de kruising van de lijnen bij het draaien op hetzelfde punt blijft.



Helderheidsinstelling
Via de 3 helderheidsinstellingen (100% - 75% - 50%) kan de intensiteit van de laser perfect aangepast worden aan de omstandigheden.



SK700DZ



SK700GDZ



SK700DZ & SK700GDZ
INCLUSIEF:
Powerpack 197658-5
t.w.v.



OPTIONEEL
CPO0000001

ADP09 Batterij adapter voor SK700
Werkt met 8 x 1,5V AA-batterijen
excl btw:
incl btw:



| | SK700DZ | SK700GDZ |
|---------------------|---------------------|---------------------|
| Kleur | Rood | Groen |
| Projecties | 3 x 360° rood | 3 x 360° groen |
| Nauwkeurigheid | ±2mm/10m | ±2mm/10m |
| Bereik | 25 m | 35 m |
| Bijgeleverde accu's | 2x BL1021B + DC105B | 2x BL1021B + DC105B |
| Gewicht | 0,99 - 1,2 kg | 0,99 - 1,2 kg |
| Prijs in € | excl. btw | |
| | incl. btw | |

Accessoires

TK0LM2000F

Statief 400 - 1140 mm
excl btw:
incl btw:



TK0LM4001F

Statief 680 - 1800 mm
excl btw:
incl btw:



TK0LM5030F

Statief 780 - 2900 mm
excl btw:
incl btw:



LE00870137

Muur- en plafondbevestiging SK105, SK106, SK700
excl btw:
incl btw:



TK00ET03F1

Muur- en plafondbevestiging SK10, SK20, SK40, SK209, SK312
excl btw:
incl btw:



LE00855702

Laserlijntonvanger (80 m) SK105, SK106, SK700
excl btw:
incl btw:



TK0LDG501G

Laserlijntonvanger SK10, SK20, SK40
excl btw:
incl btw:



TK0LDG301G

Laserlijntonvanger SK209, SK312
excl btw:
incl btw:

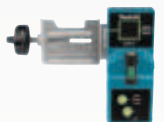

DECADP05

Adapter voor LXT batterijen
excl btw:
incl btw:



199178-5

USB voedingskabel voor ADP05 (SK105 / SK106)
excl btw:
incl btw:



199010-3

USB voedingskabel voor ADP05 (SK209 / SK312)
excl btw:
incl btw:



ACCU ROTERENDE LASER SKR001



SKR001

- Krachtige groene laser voor betere zichtbaarheid
- Meetbereik van 800 m diameter (met ontvanger)
- Te gebruiken met CXT, LXT en XGT accu's door de accuhouder te vervangen.
- Standaard geleverd met houder voor LXT.
- Zeer grote autonomie
- Loodpunt met bereik 30 m
- Nivellering met hoge precisie van $\pm 0,5$ mm op 10 m
- "H.I." alert: alarm functie wanneer de laser tijdens het werken verplaatst wordt, dit voorkomt foute metingen
- Instellingen voor vier rotatiesnelheden, scan mode (projectie van een bepaalde hoek i.p.v. 360°), projectie van afhellende lijnen
- Vier rubberen handgrepen maken het gebruik eenvoudig en kunnen de schokken van vallen opvangen
- Beschermingsgraad IP66 voor stof en water (met accu)



Digitale laserontvanger LDX2

- Detectienauwkeurigheid: $\pm 0,5$ mm
- Met LCD-venster voor en achteraan. Aanduiding van de positie van de ontvanger met pijltjes en ook weergave van de afwijking in mm
- Aanduiding van de relatieve positie van de laserstraal met 3 leds (rood/groen/blauw)
- IP67 bescherming



Afstandsbediening RX1

- Biedt alle bedieningsfuncties zoals op de laser
- Werkt met Bluetooth, bereik tot 100 m
- Slaapstand (stand-bymodus met alle functies uitgeschakeld)
- IP65 bescherming

NIEUW
SKR001Z

| | |
|-------------------------|---|
| Spanning | 36 V (40Vmax), 18V, 10,8V (12Vmax) |
| Laser | Groen 520 nm, klasse 2 |
| Bereik (met ontvanger) | \varnothing 800 m |
| Loodpunt | Opwaarts, groen, 30 m |
| Nauwkeurigheid | H: $\pm 0,5$ mm/10 m V: $\pm 0,75$ mm/10 m |
| Automatisch nivellieren | $\pm 5^\circ$ |
| Draaisnelheid | 0 / 150 / 300 / 600 min ⁻¹ |
| Gewicht | 4,9 kg |
| Prijs in € | excl. btw |
| | incl. btw |



■ Accessoires

LE00981911
Batterijhouder CXT

LE00981929
Afstandsbediening

LE00981912
Batterijhouder LXT

LE00981930
Muurbeugel

LE00981913
Batterijhouder XGT
'Beschikbaar vanaf oktober 2025'

LE01017205
Transportkoffer

LE00981928
Laserlijn ontvanger LDX2

DLM330

ACCU GRASMAAIERS 18V



LICHT EN COMPACT
KAN VERTICAAL GESTOCKEERD WORDEN
IDEAAL VOOR KLEINE OPPERVLAKTES



DLM330S5M

| | DLM330Z | DLM330SM |
|------------------------------------|--------------------------|--------------------------|
| Spanning | 1 x 18V | 1 x 18V |
| Bijgeleverde accu's | - | 1 x accu 4,0 Ah |
| Bijgeleverde Lader | - | DC18SD |
| Max. uitgangsvermogen | 450 W | 450 W |
| Maaibreedte | 33 cm | 33 cm |
| Max. aanbevolen terreinoppervlakte | 200 - 450 m ² | 200 - 450 m ² |
| Inhoud opvangbak | 30 l | 30 l |
| Chassis | Polypropyleen | Polypropyleen |
| Zelftrekkend | - | - |
| Mulching | ✓ | ✓ |
| Gewicht | 11,6 - 12,5 kg | 11,6 - 12,5 kg |
| Prijs in € | excl. btw | |
| | incl. btw | |

DLM432

ACCU GRASMAAIERS 2 x 18V



DLM432PT2

| | DLM432Z | DLM432PT2 |
|------------------------------------|--------------------------|--------------------------|
| Spanning | 2 x 18V | 2 x 18V |
| Bijgeleverde accu's | - | 2 x accu 5,0 Ah |
| Bijgeleverde Lader | - | DC18RD |
| Max. uitgangsvermogen | 900 W | 900 W |
| Maaibreedte | 43 cm | 43 cm |
| Max. aanbevolen terreinoppervlakte | 300 - 575 m ² | 300 - 575 m ² |
| Inhoud opvangbak | 40 l | 40 l |
| Chassis | Polypropyleen | Polypropyleen |
| Zelftrekkend | - | - |
| Mulching | Optioneel | Optioneel |
| Gewicht | 14,3 kg | 14,3 kg |
| Prijs in € | excl. btw | |
| | incl. btw | |

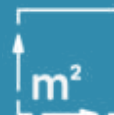

"Max aanbevolen maaioppervlakte" is de maximum oppervlakte waar de machine qua vermogen, mechaniek en werkbreedte voor geschikt is. Opgelet, dit komt niet noodzakelijk overeen met de autonomie, die afhankelijk is van het type batterijen dat gebruikt wordt en de maaioomstandigheden (de hoogte en dichtheid van het gras, de helling van het terrein enz.). Dus het kan voorkomen dat de accu's tussenin bijgeladen moeten worden om de volledige oppervlakte te kunnen maaien!

DLM480 / DLM481 / DLM539

ACCU GRASMAAIERS 2 x 18V

PROMO

DLM481CT2/ DLM481CT2:
Gratis accu 5 Ah BL1850B
na online registratie



DLM481CT2

DLM539CT2

| | DLM480CT2 | DLM481CT2 | DLM539CT2 |
|------------------------------------|--------------------------|--------------------------|---------------------------|
| Spanning | 2 x 18V | 2 x 18V | 2 x 18V |
| Bijgeleverde accu's | 2 x accu 5,0 Ah | 2 x accu 5,0 Ah | 2 x accu 5,0 Ah |
| Bijgeleverde Lader | DC18SH | DC18SH | DC18SH |
| Max. uitgangsvermogen | 860 W | 860 W | 860 W |
| Maaibreedte | 48 cm | 48 cm | 53,4 cm |
| Max. aanbevolen terreinoppervlakte | 400 - 800 m ² | 400 - 800 m ² | 500 - 1000 m ² |
| Inhoud opvangbak | 62 l | 62 l | 70 l |
| Chassis | Polypropyleen | Polypropyleen | Polypropyleen |
| Zelftrekkend | - | ✓ | ✓ |
| Mulching | ✓ | ✓ | ✓ |
| Gewicht | 24,5 - 26,8 kg | 27,1 - 29,3 kg | 28,0 - 30,5 kg |
| Prijs in € | excl. btw | | |
| | incl. btw | | |

DLM463

ACCU GRASMAAIERS 2 x 18V



DLM465PT2

DLM463PT2

| | DLM463Z | DLM463PT2 | DLM465Z | DLM465PT2 |
|------------------------------------|---------------------------|---------------------------|----------------------------|----------------------------|
| Spanning | 2x 18V | 2x 18V | 2x 18V | 2x 18V |
| Bijgeleverde accu's | - | 2x 5,0 Ah | - | 2x 5,0 Ah |
| Bijgeleverde lader | - | DC18RD | - | DC18RD |
| Max. uitgangsvermogen | 1450 W | 1450 W | 1600 W | 1600 W |
| Maaibreedte | 46 cm | 46 cm | 46 cm | 46 cm |
| Max. aanbevolen terreinoppervlakte | 800 - 1600 m ² | 800 - 1600 m ² | 1600 - 1800 m ² | 1600 - 1800 m ² |
| Inhoud opvangbak | 60 l | 60 l | 60 l | 60 l |
| Chassis | Staal | Staal | Staal | Staal |
| Zelftrekkend | - | - | ✓ | ✓ |
| Mulching | ✓ | ✓ | ✓ | ✓ |
| Gewicht | 25,3 - 27,6 kg | 25,3 - 27,6 kg | 35,3 - 39,0 kg | 35,3 - 39,0 kg |
| Prijs in € | excl. btw | | | |
| | incl. btw | | | |

DLM536 / DLM537

ACCU GRASMAAIERS 2 x 18V



DLM536Z

DLM537Z

| | DLM536Z | DLM537Z | DLM537PT4 |
|------------------------------------|----------------------------|----------------------------|----------------------------|
| Spanning | 2x 18V | 2x 18V | 2x 18V |
| Bijgeleverde lader | - | - | DC18RD |
| Bijgeleverde accu's | - | - | 4x BL1850 |
| Max. uitgangsvermogen | 1600 W | 1600 W | 1600 W |
| Maaibreedte | 53 cm | 53 cm | 53 cm |
| Max. aanbevolen terreinoppervlakte | 1600 - 1800 m ² | 1600 - 1800 m ² | 1600 - 1800 m ² |
| Inhoud opvangbak | 60 l | 60 l | 60 l |
| Chassis | Staal | Aluminium | Aluminium |
| Zelftrekkend | ✓ | ✓ | ✓ |
| Mulching | ✓ | ✓ | ✓ |
| Gewicht | 39,0 - 42,8 kg | 42,8 - 46,7 kg | 42,8 - 46,7 kg |
| Prijs in € | excl. btw | | |
| | incl. btw | | |

LM003G / LM004G
ACCUGRASMAAIER 40VMAX

PROMO

Gratis accu 4 Ah BL4040 na online registratie



LM003G & LM004G

- Budgetvriendelijk model met één 40Vmax accu
- Hoogteregeling in 10 stappen
- Verbeterde grasopvang, standaard geleverd met mes voor zowel opvangen als mulchen
- Kan zeer compact verticaal gestockeerd worden
- Speciaal mes geoptimaliseerd voor mulchen in optie verkrijgbaar



LM003GM102

| | LM003GZ | LM003GM102 | LM004GZ | LM004GM102 |
|------------------------------------|-------------------------|-------------------------|--------------------------|--------------------------|
| Spanning | 36 V (40Vmax) | 36 V (40Vmax) | 36 V (40Vmax) | 36 V (40Vmax) |
| Bijgeleverde accu's | - | 1x BL4040 | - | 1x BL4040 |
| Bijgeleverde lader | - | DC40RA | - | DC40RA |
| Max. uitgangsvermogen | 740 W | 740 W | 740 W | 740 W |
| Maalbreedte | 380 mm | 380 mm | 430 mm | 430 mm |
| Max. aanbevolen terreinoppervlakte | 75 - 780 m ² | 75 - 780 m ² | 100 - 830 m ² | 100 - 830 m ² |
| Toerental onbelast | 3800 min ⁻¹ | 3800 min ⁻¹ | 3800 min ⁻¹ | 3800 min ⁻¹ |
| Maaihoogte | 20 - 70 mm | 20 - 70 mm | 20 - 70 mm | 20 - 70 mm |
| Opvangcapaciteit | 40 l | 40 l | 50 l | 50 l |
| Mulching | ✓ | ✓ | ✓ | ✓ |
| Chassis | Polypropyleen | Polypropyleen | Polypropyleen | Polypropyleen |
| Gewicht | 14,9 - 17,3 kg | 14,9 - 17,3 kg | 15,6 - 18,2 kg | 15,6 - 18,2 kg |
| Prijs in € | excl. btw | | | |
| | incl. btw | | | |



Zelftrekkende accugrasmaaiers XGT 40Vmax



**LM001G
LM002G**

ACCUGRASMAAIER 40VMAX



PROMO

Gratis 4Ah BL4040F na online registratie voor aankopen van maart t.e.m. September 2025



| | LM001GZ | LM002GZ |
|------------------------------------|-------------------------------|-------------------------------|
| Spanning | 36 V (40Vmax) | 36 V (40Vmax) |
| Bijgeleverde accu's | | |
| Max. uitgangsvermogen | 1900 W | 1900 W |
| Maalbreedte | 48 cm | 53 cm |
| Max. aanbevolen terreinoppervlakte | 1600 - 1800 m ² | 1700 - 2000 m ² |
| Toerental onbelast | 2500 / 3200 min ⁻¹ | 2300 / 2800 min ⁻¹ |
| Maaihoogte | 20 - 100 mm | 20 - 100 mm |
| Rijsnelheid | 1,5 - 5,0 km/h | 1,5 - 5,0 km/h |
| Opvangcapaciteit | 62 l | 70 l |
| Mulching | ✓ | ✓ |
| Gewicht | 28,0 - 33,0 kg | 29,5 - 34,7 kg |
| Prijs in € | excl. btw | |
| | incl. btw | |

LM001C

GRASMAAIER MET RECHTSTREEKSE VOEDING VIA ACCUPACK



3 INSTELLINGEN :
- STANDAARD
- SOFT NO LOAD
- STILLE WERKING

LM001C



PROMO

Gratis 4Ah BL4040F na online registratie voor aankopen van maart t.e.m. September 2025



ENERGIEZUINIG MESONTWERP (onderkant toestel)



LM001C MET MONTAGE VAN PDC01 / PDC1200 (Draagbaar accupack niet inbegrepen)

| | | LM001CZ |
|------------------------|-----------|----------------------------|
| Platform | | Accupack |
| Max. uitgangsvermogen | | 1600 W |
| Maai breedte | | 53 cm |
| Maai hoogte | | 20 - 100 mm |
| Aanbevolen oppervlakte | | 1500 - 3000 m ² |
| Inhoud opvangbak | | 70l |
| Mulching | | ✓ |
| Zelftrekkend | | ✓ |
| Chassis | | Staal |
| Gewicht | | 41,9 kg |
| Prijs in € | excl. btw | |
| | incl. btw | |

Draagbaar accupack

PDC1200/ PDC1500

Met geïntegreerde accu's. Compatibel met machines met directe aansluiting en mits adapter met 2x18V en 40Vmax machines.



PDC1500



PDC01

Kan tot 4 LXT batterijen bevatten. Compatibel met machines met directe aansluiting en mits adapter met 18V, 2x18V en 40Vmax machines.



Lader voor PDC1200/PDC1500 DC4001



Adapters



Compatibel met 18V LXT producten
Enkel PDC01



Compatibel met 18V x 2 LXT producten



Compatibel met 40V XGT producten

Adapter: ref. 191N62-4



Niet alleen voor gebruik met machines met directe aansluiting

Adapter: ref. 191J51-5



Ook standaard machines die werken met 40Vmax, 2 x 18V of 18V accu's kunnen op het accupack aangesloten worden middels de juiste adapter.

Adapter: ref. 191J50-7



PDC1200/ PDC1500

met geïntegreerde accu voor 36V/40Vmax



PDC01

kan tot 4 18V accu's bevatten

Werkt uitsluitend met Makita's draagbare accupack

DUV320

ACCU VERTICUTEERMACHINES 18V



DUV320Z

| | NIEUW DUV320Z | NIEUW DUV320RT |
|-----------------------|------------------|-------------------|
| Spanning | 18V | 18V |
| Max. uitgangsvermogen | 410 W | 410 W |
| Inbegrepen accu's | - | BL1850B |
| Inbegrepen lader | - | DC18RC |
| Werkbreedte | 320 mm | 320 mm |
| Werkdiepte | -8/-4/0/+4 mm | -8/-4/0/+4 mm |
| Capaciteit opvang | 30 l | 30 l |
| Gewicht | 10,1 - 10,4 kg | 10,1 - 10,4 kg |
| Prijs in € | excl. btw | |
| | incl. btw | |

UV001G XGT 40Vmax

ACCU VERTICUTEERMACHINE 40VMAX



Hoogteregeling



Compact opbergen



De moshark is een cilinder met fijne metalen pinnen die het gras uitkamt zonder insnijdingen te maken in de bodem. Wordt gebruikt om oud gras en mos (de viltlaag) uit het gras te verwijderen. Daardoor krijgt het gras meer licht en lucht.



Het verticuteermes wordt gebruikt om de oppervlakkige wortels door te snijden hetgeen de groei stimuleert en om de water- en luchtinfiltratie te verbeteren.



- Uitgerust met krachtige BL motor op 40Vmax
- Werkt met één of twee XGT accu's, het overschakelen gaat automatisch (accu's niet mee geleverd)
- De werkdiepte is met één knop in te stellen van -12 tot 5 mm, 18 stappen
- Standaard geleverd met verticuteerrol en een accessoire voor het ontmossen zonder snijden (mosark)
- De messen met hoge duurzaamheid zijn speciaal ontworpen om lang scherp te blijven
- Zeer trillingsarm door symmetrische uitlijning van de messen en het gebruik van tegengewichten
- Inklapbare handgreep, de machine kan zeer compact opgeborgen worden
- Het kunststof onderdek mag met water afgespoeld worden voor het gemakkelijk reinigen

PROMO

voor aankopen van maart t.e.m. September: Gratis 4Ah BL4040F na online registratie*



UV001GZ

| | |
|-----------------------|----------------|
| Spanning | 36 V (40Vmax) |
| Max. uitgangsvermogen | 1700 W |
| Werkbreedte | 380 mm |
| Werkdiepte | -5 tot -12 mm |
| Capaciteit opvang | 50 l |
| Gewicht | 18,7 - 23,8 kg |
| Prijs in € | excl. btw |
| | incl. btw |

UV3200 / UV3600

ELEKTRISCHE VERTICUTEERMACHINES



UV3200



UV3600

| | UV3200 | UV3600 |
|-----------------------|-----------|---------|
| Nominaal vermogen | 1300 W | 1800 W |
| Werkbreedte | 32 cm | 36 cm |
| Polypropyleen chassis | ✓ | ✓ |
| Gewicht | 15 kg | 18,3 kg |
| Prijs in € | excl. btw | |
| | incl. btw | |

UN460W

ACCU STOKHEGGENSCHAREN 12VMAX



UN460W

UN460WDZ UN460WDWA

| | | |
|-----------------------|------------------------|------------------------|
| Accuplatform | 12Vmax | 12Vmax |
| Bijgeleverde accu's | - | 1 x accu 2,0 Ah |
| Bijgeleverde lader | - | DC10WD |
| Snijlengte | 46 cm | 46 cm |
| Maximale takdikte | 18 mm | 18 mm |
| Totale lengte | 1,889 - 2,511mm | 1,889 - 2,511mm |
| BL motor | - | - |
| Aantal snijbewegingen | 3600 min ⁻¹ | 3600 min ⁻¹ |
| Omkeerfunctie | ✓ | ✓ |
| Gewicht | 2,8 - 3,0 kg | 2,8 - 3,0 kg |
| Prijs in € | excl. btw | |
| | incl. btw | |

DUN461 / DUN500

ACCU STOKHEGGENSCHAREN 18 V

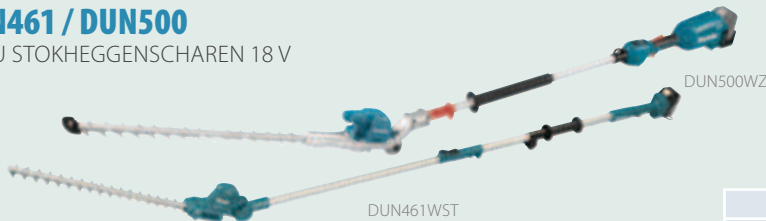

DUN461WST

DUN500WZ

DUN461WZ DUN461WST DUN500WZ

| | | | |
|-----------------------|------------------------|------------------------|----------------------------------|
| Accuplatform | 18 V | 18 V | 18 V |
| Bijgeleverde accu's | - | 1 x accu 5,0 Ah | - |
| Bijgeleverde lader | - | DC18SD | - |
| Snijlengte | 46 cm | 46 cm | 50 cm |
| Maximale takdikte | 18 mm | 18 mm | 23,5 mm |
| Totale lengte | 1,889 - 2,511mm | 1,889 - 2,511mm | 2,115 mm |
| BL motor | - | - | ✓ |
| Aantal snijbewegingen | 3600 min ⁻¹ | 3600 min ⁻¹ | 2000/3600/4400 min ⁻¹ |
| Omkeerfunctie | ✓ | ✓ | ✓ |
| Gewicht | 3,0 - 3,3 kg | 3,4 kg | 3,9 - 4,3 kg |
| Prijs in € | excl. btw | | |
| | incl. btw | | |

DUN500WZ

- Instelbaar in 6 hoeken
- Dubbele greep voor extra comfort
- Innovatieve tandengeometrie
- Totale lengte: 2,1m
- Hoog uitgangsvermogen (520 W)

DUN461

- Klassieke tandengeometrie
- Telescopische steel 1,9 m en 2,5 m

UN001GZ

ACCU STOKHEGGENSCHAREN 40VMAX



Stevig uitgevoerde scharnier voor maximale duurzaamheid

PROMO

voor aankopen van maart t.e.m. September: Gratis 4Ah BL4040F na online registratie!

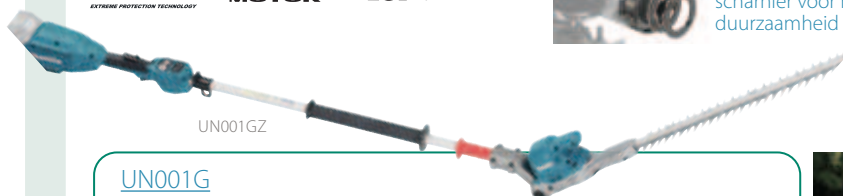

UN001GZ

UN001G

- Krachtige stokheggenschaar met een vermogen vergelijkbaar met dat van benzinemodellen, maar toch ook de lichtste in deze klasse.
- Hoekverstelbare kop; 45° omhoog kantelen tot 70° omlaag kantelen vanuit de horizontale positie. Kan 180° gekanteld worden voor gemakkelijk transport.
- Zwaar uitgevoerde messen om ook dikkere takken te kunnen knippen (terugsnoeiersie).
- Dubbelzijdig geslepen messen en tanden met 3 geslepen zijden.
- De motor is in lijn met het mes geplaatst voor een optimale balans.



UN001GZ

| | |
|-----------------------|------------------------|
| Spanning | 36V (40Vmax) |
| Bijgeleverde accu's | - |
| Bijgeleverde lader | - |
| Snijlengte | 60 cm |
| Maximale takdikte | 25 mm |
| Totale lengte | 2268 mm |
| BL motor | ✓ |
| Aantal snijbewegingen | 4000 min ⁻¹ |
| Omkeerfunctie | ✓ |
| Gewicht | 4,7 - 5,9 kg |
| Prijs in € | excl. btw |
| | incl. btw |

UM600D / DUM111 / DUM604

ACCU GRAS- EN HEGGENSCHAREN 12Vmax / 18 V

PROMO

Gratis opbergtas
831253-8
bij UM600DAEX, DUM-
111SYX en DUM604RFEX



DUM604RFEX



DUM111SYX



| | UM600DAEX | DUM111SYX | DUM604RFEX | DUM604ZX |
|-------------------------|---------------------------|---------------------------|---------------------------|---------------------------|
| Spanning | 10,8 V (12Vmax) | 18 V | 18 V | 18 V |
| Bijgeleverde accu's | 2 x accu 2,0 Ah | 1 x accu 1,5 Ah | 2 x accu 3,0 Ah | - |
| Lader | DC10SB | DC18SD | DC18RC | - |
| Snijlengte heggenschaar | 20 cm | 20 cm | 20 cm | 20 cm |
| Snijbreedte grasschaar | 16 cm | 11 cm | 16 cm | 16 cm |
| Maximale takdikte | 8 mm | - | 10 mm | 10 mm |
| Geleverd met | Grasschaar + Heggenschaar | Grasschaar + Heggenschaar | Grasschaar + Heggenschaar | Grasschaar + Heggenschaar |
| Gewicht | 1,2 kg | 1,8 kg | 1,8 kg | 1,8 kg |
| Prijs in € | excl. btw | | | |
| | incl. btw | | | |

DUH507 / DUH607

ACCU HEGGENSCHAREN 18 V



DUH607Z



DUH507 & DUH607:

- Budgetvriendelijke versies
- Compact en uiterst licht
- Versterkt krukasmecanisme
- Handgreep met nieuw ontworpen schakelaar
- Hoogwaardige trillingsdemping

| | DUH507Z | DUH507F001 | DUH607Z | DUH607F001 |
|-----------------------|------------------------|------------------------|------------------------|------------------------|
| Spanning | 18V | 18V | 18V | 18V |
| Bijgeleverde accu's | - | 1x accu 3,0 Ah | - | 1x accu 3,0 Ah |
| Bijgeleverde lader | - | DC18WC | - | DC18WC |
| BL motor | - | - | - | - |
| Snijlengte | 50 cm | 50 cm | 60 cm | 60 cm |
| Maximale takdikte | 15 mm | 15 mm | 15 mm | 15 mm |
| Aantal snijbewegingen | 2700 min ⁻¹ | 2700 min ⁻¹ | 2700 min ⁻¹ | 2700 min ⁻¹ |
| Max. uitgangsvermogen | 250 W | 250 W | 250 W | 250 W |
| Gewicht | 2,7 - 3,0 kg | 2,7 - 3,0 kg | 2,8 - 3,1 kg | 2,8 - 3,1 kg |
| Prijs in € | excl. btw | | | |
| | incl. btw | | | |

DUH506 / DUH606

ACCU HEGGENSCHAREN 18 V



DUH606RF



DUH506 & DUH606:

- Zeer efficiënt dankzij BL motor
- Compact en uiterst licht
- Versterkt krukasmecanisme
- Handgreep met nieuw ontworpen schakelaar
- Hoogwaardige trillingsdemping

| | DUH506Z | DUH506RF | DUH606Z | DUH606RF |
|-----------------------|------------------------|------------------------|------------------------|------------------------|
| Spanning | 18V | 18V | 18V | 18V |
| Bijgeleverde accu's | - | 1x accu 3,0 Ah | - | 1x accu 3,0 Ah |
| Bijgeleverde lader | - | DC18RC | - | DC18RC |
| BL motor | ✓ | ✓ | ✓ | ✓ |
| Snijlengte | 50 cm | 50 cm | 60 cm | 60 cm |
| Max. takdikte | 20 mm | 20 mm | 20 mm | 20 mm |
| Aantal snijbewegingen | 4000 min ⁻¹ | 4000 min ⁻¹ | 4000 min ⁻¹ | 4000 min ⁻¹ |
| Max. uitgangsvermogen | 320 W | 320 W | 320 W | 320 W |
| Gewicht | 2,5 - 2,9 kg | 2,5 - 2,9 kg | 2,7 - 3,0 kg | 2,7 - 3,0 kg |
| Prijs in € | excl. btw | | | |
| | incl. btw | | | |

DUH502 / DUH602 / DUH752

ACCU HEGGENSCHAREN 18 V



TANDEN MET KLASSIEKE GEOMETRIE

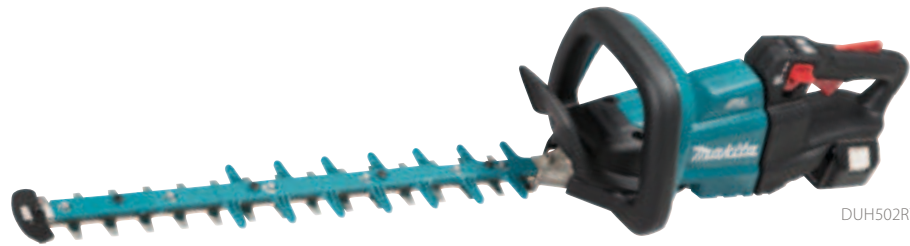

DUH502RT

| | DUH502Z | DUH502RT | DUH602Z | DUH602RT | DUH752Z | DUH752RT |
|-----------------------|--------------------------------------|--------------------------------------|--------------------------------------|--------------------------------------|--------------------------------------|--------------------------------------|
| Spanning | 18V | 18V | 18V | 18V | 18V | 18V |
| Bijgeleverde accu's | - | 1 x accu 5,0 Ah | - | 1 x accu 5,0 Ah | - | 1 x accu 5,0 Ah |
| Bijgeleverde lader | - | 1 x DC18RC | - | 1 x DC18RC | - | 1 x DC18RC |
| BL motor | ✓ | ✓ | ✓ | ✓ | ✓ | ✓ |
| Snijlengte | 50 cm | 50 cm | 60 cm | 60 cm | 75 cm | 75 cm |
| Max. takdikte | 21,5 mm | 21,5 mm | 21,5 mm | 21,5 mm | 21,5 mm | 21,5 mm |
| Aantal snijbewegingen | 2000 / 3600 / 4400 min ⁻¹ | 2000 / 3600 / 4400 min ⁻¹ | 2000 / 3600 / 4400 min ⁻¹ | 2000 / 3600 / 4400 min ⁻¹ | 2000 / 3600 / 4400 min ⁻¹ | 2000 / 3600 / 4400 min ⁻¹ |
| Max. uitgangsvermogen | 520 W | 520 W | 520 W | 520 W | 520 W | 520 W |
| Gewicht | 3,8 kg | 3,8 kg | 3,8 kg | 3,8 kg | 3,8 kg | 3,8 kg |
| Prijs in € | excl. btw | | | | | |
| | incl. btw | | | | | |

DUH501 / DUH601 / DUH751 / DUH754S

ACCU HEGGENSCHAREN 18 V



TANDEN MET INNOVATIEVE GEOMETRIE

DUH501RTE



DUH754SZ
(ENKELZIJDIG MES)

INNOVATIEVE GEOMETRIE

- Beter snijresultaat
- Minder wrijving
- Grotere batterijautonomie

| | DUH501Z | DUH501RTE | DUH601Z | DUH601PTE | DUH751Z | DUH751PTE | DUH754SZ |
|-----------------------|----------------------------------|----------------------------------|----------------------------------|----------------------------------|----------------------------------|----------------------------------|----------------------------------|
| Uitvoering | Trim | Trim | Trim | Trim | Trim | Trim | Trim |
| Mes | Dubbelzijdig | Dubbelzijdig | Dubbelzijdig | Dubbelzijdig | Dubbelzijdig | Dubbelzijdig | Enkelzijdig |
| Bijgeleverde accu's | - | 2 x accu 5,0 Ah | - | 2 x accu 5,0 Ah | -- | 2 x accu 5,0 Ah | - |
| Bijgeleverde Lader | - | 1 x DC18RC | - | 1 x DC18RD | - | 1 x DC18RD | - |
| BL motor | ✓ | ✓ | ✓ | ✓ | ✓ | ✓ | ✓ |
| Aantal snijbewegingen | 2000/3600/4400 min ⁻¹ | 2000/3600/4400 min ⁻¹ | 2000/3600/4400 min ⁻¹ | 2000/3600/4400 min ⁻¹ | 2000/3600/4400 min ⁻¹ | 2000/3600/4400 min ⁻¹ | 2000/3600/4400 min ⁻¹ |
| Snijlengte | 50 cm | 50 cm | 60 cm | 60 cm | 75 cm | 75 cm | 75 cm |
| Max. takdikte | 23,5 mm | 23,5 mm | 23,5 mm | 23,5 mm | 23,5 mm | 23,5 mm | 23,5 mm |
| Max. uitgangsvermogen | 520 W | 520 W | 520 W | 520 W | 520 W | 520 W | 520 W |
| Gewicht | 3,8 - 4,5 kg | 3,8 - 4,5 kg | 3,8 - 4,5 kg | 3,8 - 4,5 kg | 3,8 - 4,5 kg | 3,8 - 4,5 kg | 3,4 - 3,9 kg |
| Prijs in € | excl. btw | | | | | | |
| | incl. btw | | | | | | |

UH020GZ / UH021GZ

ACCU HEGGENSCHAREN 40VMAX



UH020G-UH021G

- Uiterst lichte machine, dit maakt het werk veel minder vermoeiend.
- Ideaal voor het trimmen van fijne hagen (dunnere takken)
- Uitgerust met sterke BL motor, voeding met XGT 40Vmax accu
- Compact waardoor deze gemakkelijk te hanteren is, ook bij heggen met veel gebogen oppervlakken.
- Driezijdig geslepen tanden voor een optimaal snijresultaat
- Omkeerfunctie voor gemakkelijk deblokken van het mes



UH021GZ

PROMO

voor aankopen van maart t.e.m. September: Gratis 4Ah BL4040F na online registratie



| | UH020GZ | UH021GZ |
|-----------------------|------------------------|------------------------|
| Uitvoering | Trim | Trim |
| Mes | Dubbelzijdig | Dubbelzijdig |
| Bijgeleverde accu's | - | - |
| Bijgeleverde lader | - | - |
| Aantal snijbewegingen | 4200 min ⁻¹ | 4200 min ⁻¹ |
| Snijlengte | 50 cm | 60 cm |
| Max. takdikte | 20 mm | 20 mm |
| Max. uitgangsvermogen | 460 W | 460 W |
| Gewicht | 3,0 - 4,2 kg | 3,0 - 4,2 kg |
| Prijs in € | excl. btw | |
| | incl. btw | |

UH004G / UH005G

ACCU HEGGENSCHAREN 40VMAX 'TRIMVERSIE'



PROMO

voor aankopen van maart t.e.m. September: Gratis 4Ah BL4040F na online registratie

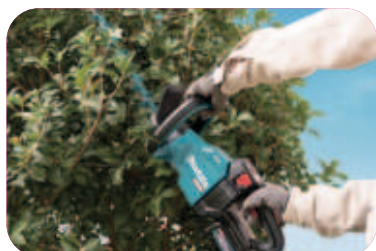

TANDEN MET 3 GESLEPEN KANTEN EN GEBOGEN VOOR MINDER WRIJVING
INNOVATIEVE (ASYMMETRISCHE) TANDGEOMETRIE IDEEAAL VOOR DUNNE TAKKEN EN DICHTHEGGEN

UH004GM201



| | UH004GZ | UH004GM201 | UH005GZ | UH005GM201 |
|-----------------------|--------------------------------------|--------------------------------------|--------------------------------------|--------------------------------------|
| Uitvoering | Trim | Trim | Trim | Trim |
| Mes | Dubbelzijdig | Dubbelzijdig | Dubbelzijdig | Dubbelzijdig |
| Bijgeleverde accu's | - | 2x BL4040 | - | 2x BL4040 |
| Bijgeleverde lader | - | DC40RA | - | DC40RA |
| Aantal snijbewegingen | 2000/3600/ 5000 min ⁻¹ | 2000/3600/ 5000 min ⁻¹ | 2000/3600/ 5000 min ⁻¹ | 2000/3600/ 5000 min ⁻¹ |
| Snijlengte | 60 cm | 60 cm | 75 cm | 75 cm |
| Max. takdikte | 23,5 mm | 23,5 mm | 23,5 mm | 23,5 mm |
| Max. uitgangsvermogen | 720 W | 720 W | 720 W | 720 W |
| Gewicht | 4,3 - 4,9 kg | 4,3 - 4,9 kg | 4,5 - 5,1 kg | 4,5 - 5,1 kg |
| Prijs in € | excl. btw | | | |
| | incl. btw | | | |

UH006G / UH007G

ACCU HEGGENSCHAREN 40VMAX 'TERUGSNOEIVERSIE'



PROMO

voor aankopen van maart t.e.m. september '25: Gratis 4 Ah BL4040F na online registratie



- Innovatieve (asymmetrische) tandgeometrie
- Zwaarder uitgevoerd mes en grotere tandafstand
- Ideaal voor dikkere takken

UH006GM201



| | UH006GZ | UH006GM201 | UH007GZ | UH007GM201 |
|-----------------------|--------------------------------------|--------------------------------------|--------------------------------------|--------------------------------------|
| Uitvoering | Terugsnoei | Terugsnoei | Terugsnoei | Terugsnoei |
| Mes | Dubbelzijdig | Dubbelzijdig | Dubbelzijdig | Dubbelzijdig |
| Bijgeleverde accu's | - | 2x BL4040 | - | 2x BL4040 |
| Bijgeleverde lader | - | DC40RA | - | DC40RA |
| Aantal snijbewegingen | 2000/3000/ 4000 min ⁻¹ | 2000/3000/ 4000 min ⁻¹ | 2000/3000/ 4000 min ⁻¹ | 2000/3000/ 4000 min ⁻¹ |
| Snijlengte | 60 cm | 60 cm | 75 cm | 75 cm |
| Max. takdikte | 25 mm | 25 mm | 25 mm | 25 mm |
| Max. uitgangsvermogen | 720 W | 720 W | 720 W | 720 W |
| Gewicht | 4,4 - 5,0 kg | 4,4 - 5,0 kg | 4,6 - 5,2 kg | 4,6 - 5,2 kg |
| Prijs in € | excl. btw | | | |
| | incl. btw | | | |

DUB187

ACCU BLADBLAZER / - ZUIGER 18 V



DUB187T001

Optioneel accessoire

GB00000165
T-vormig mondstuk
geschikt voor DUB187



| | DUB187Z | DUB187T001 |
|------------------------|--------------|--------------|
| Spanning | 18V | 18V |
| Bijgeleverde accu's | - | BL1850B |
| Bijgeleverde lader | - | DC18WC |
| Luchtsnelheid (blazen) | 64 m/s | 64 m/s |
| Max. debiet (zuigen) | 6,1 m³/min | 6,1 m³/min |
| Max. onderdruk | 33 mbar | 33 mbar |
| Max. blaaskracht | 4,2 N | 4,2 N |
| Gewicht | 3,7 - 4,0 kg | 3,7 - 4,0 kg |
| Prijs in € | excl. btw | |
| | incl. btw | |

DUB184

ACCU BLADBLAZER 18 V



| | DUB184Z | DUB184RT |
|---------------------|--------------|--------------|
| Spanning | 18V | 18V |
| Bijgeleverde accu's | - | 1 x BL1850B |
| Bijgeleverde lader | - | DC18RC |
| Luchtsnelheid | 49 m/s | 49 m/s |
| Max. debiet | 12,7 m³/min | 12,7 m³/min |
| Max. blaaskracht | 10,9 N | 10,9 N |
| Gewicht | 2,5 - 3,0 kg | 2,5 - 3,0 kg |
| Prijs in € | excl. btw | |
| | incl. btw | |

UB001GZ

ACCU BLADBLAZER 40VMAX



Zeer hoog blaasvermogen (tot 17 N in Boost mode).
Variabele snelheid en cruise control.
Hertekend ontwerp voor nog hoger gebruikscomfort.
WetGuard/IPX4 bescherming

| | UB001GZ |
|---------------------|--------------|
| Spanning | 36V (40Vmax) |
| Bijgeleverde accu's | 0 |
| Bijgeleverde lader | - |
| Max. luchtsnelheid | 64 m/s |
| Max. debiet | 16,0 m³/min |
| Gewicht | 3,1 - 3,9 kg |
| Prijs in € | excl. btw |
| | incl. btw |

DUB363

ACCU BLADBLAZER / -ZUIGER 2 x 18 V



Geleverd met bladzuigset

DUB362

ACCU BLADBLAZER 2 x 18 V



DUB362Z

| | DUB363ZV | DUB362Z | DUB362TX1 |
|---------------------|--------------|--------------|--------------|
| Spanning | 2 x 18V | 2x18V | 2x18V |
| Bijgeleverde accu's | - | - | 4 x BL1850B |
| Bijgeleverde lader | - | - | DC18RD |
| Luchtsnelheid | 54 m/s | 54 m/s | 54 m/s |
| Max. debiet | 13,4 m³/min | 13,4 m³/min | 13,4 m³/min |
| Max. blaaskracht | 14,4 N | 14,4 N | 14,4 N |
| Gewicht | 4,5 - 6,6 kg | 3,5 - 4,2 kg | 3,5 - 4,2 kg |
| Prijs in € | excl. btw | | |
| | incl. btw | | |

UB001C / UB003C

BLADBLAZER MET RECHTSTREEKSE AANSLUITING OP ACCUPACK



UB001CZ

UB003CZ

PROMO

voor aankopen van maart t.e.m. September: Gratis 4Ah BL4040F na online registratie



UB003C

- Voor gebruik in combinatie met PDC01, PDC1200 of PDC1500 (directe aansluiting)
- Levert het hoogste blaasvermogen (24 N) in combinatie met PDC1500
- Hoge luchtstroom door een verbeterde vorm van de vaste bladen in de turbine
- Laag gewicht

| | UB001CZ | UB003CZ |
|--------------------|--|---------------------------|
| Platform | PDC01/PDC1200/ PDC1500 | PDC01/PDC1200/ PDC1500 |
| Max. luchtsnelheid | 60 m/s (70 m/s boost) | 86 m/s |
| Max. debiet | 15 m ³ /min (17,6 m ³ /min boost) | 17,6 m ³ /min |
| Max. blaaskracht | 15 N (20 N boost) | 24 N |
| Autonomie | 60 min (20 N, PDC1200) | 60 min (24 N, PDC1500) |
| Gewicht | 2,6 kg | 2,8 - 3,1 kg |
| Prijs in € | excl. btw | |
| | incl. btw | |

UB002CZ / UB004CZ

RUGGEDRAGEN BLADBLAZER MET RECHTSTREEKSE AANSLUITING OP ACCUPACK



PROMO

Voor aankopen van maart t.e.m. september '25: gratis BL4040F na online registratie



UB002CZ

UB004CZ



Het accupack kan in één beweging op de machine vastgeklit worden.



Triggerschakelaar met variabele snelheid en "cruise control" hendel.



De bedieningshendel kan horizontaal verschoven en gekanteld worden.

ACCU NIET INBEGREPEN!

UB004C

- Voor gebruik in combinatie met PDC1200 of PDC1500
- Nieuw ontwerp met de turbine in lijn met de blaaspijp zorgt voor een nog betere efficiëntie. Hoge blaaskracht van 25 N en tot 28 N in "Boost" modus
- Drie instelbare maximumsnelheden, trigger met variabele snelheid, cruisecontrol
- Telescopische blaasmond met traploze afstelling van de lengte en verstelbare greep
- Uiterst comfortabel harnas

Optioneel accessoire (UB004C)

1914H0-2
Blaasmond



1914H1-0
Blaasmond



| | UB002CZ | UB004CZ |
|--------------------|---------------------------|--|
| Platform | Accupack PDC1200 | PDC |
| Luchtsnelheid | 71,7 m/s | 76,3 m/s (80,7 m/s Boost) |
| Max. debiet | 19 m ³ /min | 19,7 m ³ /min (20,9 m ³ /min Boost) |
| Max. blaaskracht | 22 N | 25 N (28 N Boost) |
| Geluidsdruk niveau | 81 dB (A) | 82,3 dB(A) |
| Autonomie | 45 min (22 N, PDC1200) | 55 min (25 N, PDC1500) |
| Gewicht | 15,9 - 16,1 kg | 16,5 - 18,6 kg (PDC1200-PDC1500) |
| Prijs in € | excl. btw | |
| | incl. btw | |

DUR193

ACCU GRASTRIMMER 18V



DUR193RF

| | DUR193Z | DUR193RF |
|-----------------------|--------------|-----------------|
| Spanning | 18 V | 18 V |
| Bijgeleverde accu's | - | 1 x accu 3,0 Ah |
| Bijgeleverde lader | - | DC18RC |
| Snelheden | 1 | 1 |
| BL motor | - | - |
| ADT | - | - |
| AFT | - | - |
| Handgreep | D | D |
| Schacht | Telescopisch | Telescopisch |
| Max. uitgangsvermogen | 280 W | 280 W |
| Gewicht | 2,3 - 2,6 kg | 2,3 - 2,6 kg |
| Prijs in € | excl. btw | |
| | incl. btw | |

DUR192

ACCU GRASTRIMMERS 18V



DUR369AZ

| | DUR192LZ | DUR192LST |
|-----------------------|-----------|-----------------|
| Spanning | 18V | 18V |
| Bijgeleverde accu's | - | 1 x accu 5,0 Ah |
| Bijgeleverde lader | - | DC18SD |
| Snelheden | 2 | 2 |
| ADT | - | - |
| AFT | - | - |
| Handgreepvorm | D | D |
| Max. uitgangsvermogen | 460 W | 460 W |
| Gewicht | 3,4 kg | 3,4 kg |
| Prijs in € | excl. btw | |
| | incl. btw | |

DUR194

ACCU GRASTRIMMER 18V



- COMPATIBEL MET DRAADKOP, KOP MET NYLON MESSEN EN METALEN 8-TANDS MAAIBLAD
- MET UNIVERSELE BESCHERMKAP



DUR194SFX2

| | DUR194ZX3 | DUR194SFX2 | DUR194RTX1 |
|-----------------------|--------------|----------------|----------------|
| Spanning | 18 V | 18 V | 18 V |
| Bijgeleverde accu's | - | 1x accu 3,0 Ah | 1x accu 5,0 Ah |
| Bijgeleverde lader | - | DC18SD | DC18RC |
| Snelheden | 2 | 2 | 2 |
| BL motor | - | - | - |
| ADT | - | - | - |
| AFT | - | - | - |
| Handgreep | D | D | D |
| Max. uitgangsvermogen | 230 W | 230 W | 230 W |
| Gewicht | 2,6 - 2,9 kg | 2,6 - 2,9 kg | 2,6 - 2,9 kg |
| Prijs in € | excl. btw | | |
| | incl. btw | | |

DUR189

ACCU GRASTRIMMERS 18V



ERGONOMISCHE, GEBOGEN SCHACHT



DUR189RFE

| | DUR189Z | DUR189RFE |
|-----------------------|--------------|----------------|
| Bijgeleverde accu's | - | 2x accu 3,0 Ah |
| Bijgeleverde lader | - | DC18RC |
| Snelheden | 3 | 3 |
| ADT | ✓ | ✓ |
| AFT | - | - |
| Handgreepvorm | D | D |
| Max. uitgangsvermogen | 240 W | 240 W |
| Gewicht | 3,0 - 3,3 kg | 3,0 - 3,3 kg |
| Prijs in € | excl. btw | |
| | incl. btw | |

DUR190 / DUR191

ACCU GRASTRIMMERS 18 V



PROMO

Promo: Gratis BL1850B na online registratie



SCHACHT IN ÉÉN DEEL (DUR190)

DEMONTTEERBARE SCHACHT VOOR TRANSPORT (DUR191)

DUR190UT11 INCLUSIEF 4-TANDS MAAIMES (195150-5)



DUR190UT11

DUR191LZX3

| | DUR190LZX9 | DUR190UZ9 | DUR190UT11 | DUR191LZX3 |
|-----------------------|--------------|--------------|-----------------|--------------|
| Spanning | 18V | 18V | 18V | 18V |
| Bijgeleverde accu's | - | - | 1 x accu 5,0 Ah | - |
| Lader | - | - | DC18SD | - |
| Snelheden | 3 | 3 | 3 | 3 |
| ADT | ✓ | ✓ | ✓ | ✓ |
| AFT | ✓ | ✓ | ✓ | ✓ |
| Handgreepvorm | D | U | U | D |
| Easy-fill maaikop | ✓ | ✓ | ✓ | - |
| Max. uitgangsvermogen | 240 W | 240 W | 240 W | 240 W |
| Gewicht | 2,9 - 3,2 kg | 3,4 - 3,7 kg | 3,4 - 3,7 kg | 3,2 - 3,5 kg |
| Prijs in € | excl. btw | | | |
| | incl. btw | | | |

DUR368 / DUR369

ACCU BOSMAAIERS 2X18V



DUR369AZ



DUR368LZ

| | DUR368LZ | DUR368AZ | DUR369AZ |
|-------------------------|--------------|--------------|--------------|
| Spanning | 2x 18V | 2x 18V | 2x 18V |
| Max. toerental onbelast | 6500 t.p.m. | 6500 t.p.m. | 7000 t.p.m. |
| Bijgeleverde accu's | - | - | - |
| Bijgeleverde lader | - | - | - |
| Snelheden | 3 | 3 | 3 |
| ADT | ✓ | ✓ | ✓ |
| AFT | ✓ | ✓ | ✓ |
| Handgreep | D | U | U |
| Max. uitgangsvermogen | 550 W | 550 W | 1000 W |
| Gewicht | 3,9 - 4,5 kg | 4,1 - 4,7 kg | 5,9 - 6,5 kg |
| Prijs in € | excl. btw | | |
| | incl. btw | | |



UR002G / UR006G / UR007G / UR016G / UR017G

ACCU BOSMAAIERS 40VMAX

PROMO

voor aankopen van maart t.e.m. September: Gratis 4Ah BL4040F na online registratie"



UR002GZ01

UR017GZ

UR006GM102



UR006G/UR007G:

Uitstekende balans dankzij de achteraan geplaatste motor. De BL motor met geforceerde koeling levert een maximaal vermogen van 1,0 kW. Zeer hoge rotatiesnelheid.

UR006G: met dubbele handgreep ("U")

UR007G: met ronde handgreep ("D")

Geschikt voor zware toepassingen.

UR002G

De boven de maaikop geplaatste BL motor met externe rotor werkt efficiënt en heeft een hoog koppel.

UR016G/UR017G:

- Budgetvriendelijke trimmer / bosmaaier voor lichter werk
- Goede balans door achteraan geplaatste motor
- 3 vaste snelheden
- Lichtere constructie van motor, maaikop en aandrijfas
- Geleverd met Easy-fill maai-kop

| | UR002GZ01 | UR016GZ | UR017GZ | UR006GZ02 | UR006GM102 | UR007GZ01 |
|-------------------------|--------------------------------------|----------------------------------|----------------------------------|--------------------------------------|--------------------------------------|--------------------------------------|
| Spanning | 36V (40Vmax) | 36V (40Vmax) | 36V (40Vmax) | 36V (40Vmax) | 36V (40Vmax) | 36V (40Vmax) |
| Max. toerental onbelast | 3500 - 5300 - 6500 min ⁻¹ | 3500/5300/6500 min ⁻¹ | 3500/5300/6500 min ⁻¹ | 4600 - 5500 - 7000 min ⁻¹ | 4600 - 5500 - 7000 min ⁻¹ | 4600 - 5500 - 7000 min ⁻¹ |
| Snelheden | 3 + auto | 3 | 3 | 3 + auto | 3 + auto | 3 + auto |
| Handgreepvorm | Dubbele handgreep ("U") | U | D | Dubbele handgreep ("U") | Dubbele handgreep ("U") | Rond ("D") |
| ADT | ✓ | ✓ | ✓ | ✓ | ✓ | ✓ |
| AFT | ✓ | ✓ | ✓ | ✓ | ✓ | ✓ |
| Bijgeleverde accu's | - | - | - | - | 1 x BL4040 | - |
| Bijgeleverde lader | - | - | - | - | DC40RA | - |
| Max. uitgangsvermogen | 550 W | 600 W | 600 W | 1 kW | 1 kW | 1 kW |
| Gewicht | 4,6 - 5,3 kg | 4,7 - 5,3 kg | 4,2 - 4,8 kg | 5,7 - 6,3 kg | 5,7 - 6,3 kg | 5,7 - 6,3 kg |
| Prijs in € | excl. btw | | | | | |
| | incl. btw | | | | | |

UR013G / UR014G

ACCU BOSMAAIERS 40VMAX

PROMO

voor aankopen van maart t.e.m. september '25: Gratis 4 Ah BL4040F na online registratie



UR013GZ04

UR014GZ

UR012GZ06



- 8-polige motor met hoog koppel en laag toerental
- Laag geluidsniveau
- UR013G: dubbele handgreep met gereedschapsloze verstelling en "high torque mode". Deze versie is ook geschikt voor gebruik met een zaagblad of hakselblad
- UR014G: met ronde greep, twee draairichtingen, enkel te gebruiken met draadkop
- "Cruise control" hendel voor het aanhouden van de gekozen snelheid.

| | UR013GZ04 | UR014GZ | UR012GZ06 |
|-----------------------|-------------------------------|-------------------------------|--------------------------------------|
| Spanning | 36V (40Vmax) | 36V (40Vmax) | 72V (2x 40Vmax) |
| Toerental onbelast | 3500 - 6700 min ⁻¹ | 4000 - 5000 min ⁻¹ | 3500 - 5000 - 6800 min ⁻¹ |
| Bijgeleverde accu's | - | - | - |
| Bijgeleverde lader | - | - | - |
| Handgreepvorm | Dubbele handgreep ("U") | Rond ("D") | Dubbele handgreep ("U") |
| ADT | - | - | - |
| AFT | ✓ | ✓ | ✓ |
| Max. uitgangsvermogen | 1500 W | 1500 W | 2000 W |
| Gewicht | 5,9 - 7,2 kg | 5,5 - 6,7 kg | 8,0 - 9,8 kg |
| Prijs in € | excl. btw | | |
| | incl. btw | | |

UC100D / DUC101 / DUC150

ACCU SNOEIZAGEN



DUC101SF

Holster

**optioneel accessoire**

| Ref. | Prijs excl. btw | Prijs incl. btw |
|----------|-----------------|-----------------|
| 1913K4-9 | | |

Geschikt voor DUC101 / DUC150 / UC029G

LICHT EN GOED UITGEBALANCEERD
GEREEDEDSCHAPLOZE, AUTOMATISCHE
KETTINGSPANNER

BEWEEGBARE KETTINGBESCHERMER
AUTOMATISCHE KETTINGSMERING
50 ML OLIERESERVOIR MET VENSTER
OPGELET: STEEDS MET TWEE HANDEN
BEDIENEN!



| | UC100DZ | DUC101Z | DUC101SF | DUC150Z |
|---------------------|---------------------------|---------------------------|---------------------------|---------------------------|
| Spanning | 10,8V (12Vmax) | 18V | 18V | 18V |
| Bijgeleverde accu's | - | - | 1x accu 3,0 Ah | - |
| Bijgeleverde lader | - | - | DC18SD | - |
| BL motor | ✓ | ✓ | ✓ | ✓ |
| Snelspansysteem | ✓ | ✓ | ✓ | ✓ |
| Zwaardlengte | 100 mm | 100 mm | 100 mm | 150 mm |
| Ketting | 80 TXL (0,325, 1,1 mm) | 80 TXL (0,325, 1,1 mm) | 80 TXL (0,325, 1,1 mm) | 80 TXL (0,325, 1,1 mm) |
| Kettingsnelheid | 8 m/s | 8 m/s | 8 m/s | 8 m/s |
| Gewicht | 1,5-1,6 kg | 1,6-2,0 kg | 1,6-2,0 kg | 1,7-2,0 kg |
| Prijs in € | excl. btw | | | |
| | incl. btw | | | |

UC029GZ

ACCU SNOEIZAGEN 40VMAX



Draaghaak

**optioneel accessoire**

| Ref. | Prijs excl. btw | Prijs incl. btw |
|----------|-----------------|-----------------|
| 1914Y8-5 | | |

Geschikt voor UC029G

PROMO

Gratis 4 Ah BL4040F na
online registratie
voor aankopen van maart
t.e.m. september '25

**NIEUW****UC029GZ**

ZEER KRACHTIG EN TOCH COMPACT EN
LICHT DANKZIJ 40VMAX TECHNOLOGIE
AUTOMATISCHE KETTINGSMERING EN
TRANSPARENT OLIERESERVOIR
GEREEDEDSCHAPLOS AANSPANNEN EN
WISSELEN VAN DE KETTING

DE VEILIGHEIDSVERGRENDELING
VOORKOMT ACCIDENTEEL INSCHAKELLEN

AANDACHT VOOR VEILIGHEID: DE
MACHINE IS VOORZIEN VAN EEN BREDE
HANDBESCHERMING ONDERAAN EN EEN
KETTINGBESCHERMER DIE MEE BEWEEGT
TIJDENS HET ZAGEN

| | |
|---------------------|---------------------------|
| Spanning | 36V (40Vmax) |
| Bijgeleverde accu's | - |
| Bijgeleverde lader | - |
| BL motor | ✓ |
| Snelspansysteem | ✓ |
| Zwaardlengte | 150 mm |
| Ketting | 80 TXL (0,325, 1,1 mm) |
| Kettingsnelheid | 8 m/s |
| Gewicht | 2,1- 2,4 kg |
| Prijs in € | excl. btw |
| | incl. btw |



DUC122 / DUC254

ACCU SNOEIKETTINGZAGEN 18V



DUC254

DUC254

OPGELET: voor het gebruik van een tophandle kettingzaag is een opleiding vereist. Raadpleeg steeds de veiligheidsvoorschriften.



DUC122RTE

DUC254Z001

| | DUC122ZK | DUC122RTE | DUC254Z001 |
|---------------------|-----------------------|-----------------------|---------------------------|
| Spanning | 18V | 18V | 18V |
| Bijgeleverde accu's | - | 2 x accu 5,0 Ah | - |
| Bijgeleverde lader | - | DC18RC | - |
| BL motor | - | - | ✓ |
| Spansysteem | Snelspansysteem | Snelspansysteem | Geïntegreerde moeren |
| Zwaardlengte | 11,5 cm | 11,5 cm | 25 cm |
| Ketting | 025 (1/4", 1,3 mm) | 025 (1/4", 1,3 mm) | 80TXL (0,325", 1,1 mm) |
| Kettingsnelheid | 5 m/s | 5 m/s | 24 m/s |
| Gewicht | 2,6 kg | 2,6 kg | 2,8 - 3,2 kg |
| Prijs in € | excl. btw | | |
| | incl. btw | | |

DUC256 / DUC306 / DUC356 / DUC406

ACCU SNOEIKETTINGZAGEN 2 x 18V



DUC256Z001

DUC256Z001 DUC306Z001 DUC356Z001 DUC406Z001

| | DUC256Z001 | DUC306Z001 | DUC356Z001 | DUC406Z001 |
|----------------------|------------------------------|------------------------------|----------------------------|------------------------------|
| Spanning | 2x 18V | 2x 18V | 2x 18V | 2x 18V |
| Bijgeleverde accu's | - | - | - | - |
| Bijgeleverde lader | - | - | - | - |
| BL motor | ✓ | ✓ | ✓ | ✓ |
| Snelspansysteem | - | - | - | - |
| Geïntegreerde moeren | ✓ | ✓ | ✓ | ✓ |
| Zwaardlengte | 25 cm | 30 cm | 35 cm | 40 cm |
| Ketting | 80 TXL (0,325, 1,1 mm) | 80 TXL (0,325, 1,1 mm) | 80TXL (0,325, 1,1mm) | 80 TXL (0,325, 1,1 mm) |
| Kettingsnelheid | 20 m/s | 20 m/s | 20 m/s | 20 m/s |
| Gewicht | 4,6-5,1 kg | 4,6-5,1 kg | 4,6-5,1 kg | 4,6-5,1 kg |
| Prijs in € | excl. btw | | | |
| | incl. btw | | | |

UC002G / UC003G / UC004G / UC006G

ACCU SNOEIKETTINGZAGEN 40VMAX

PROMO

Voor aankopen van maart t.e.m. september '25: gratis BL4040F na online registratie



Met carvingblad

UC006GZ

UC003GM101

| | UC002GZ | UC002GM101 | UC003GZ | UC003GM101 | UC004GZ | UC004GM101 | UC006GZ |
|----------------------|-----------------------|-----------------------|-----------------------|-----------------------|-----------------------|-----------------------|------------------------|
| Spanning | 36V (40Vmax) | 36V (40Vmax) | 36V (40Vmax) | 36V (40Vmax) | 36V (40Vmax) | 36V (40Vmax) | 36V (40Vmax) |
| Bijgeleverde accu's | - | 1x 4,0 Ah | - | 1x 4,0 Ah | - | 1x 4,0 Ah | - |
| Bijgeleverde lader | - | DC40RA | - | DC40RA | - | DC40RA | - |
| BL motor | ✓ | ✓ | ✓ | ✓ | ✓ | ✓ | ✓ |
| Geïntegreerde moeren | ✓ | ✓ | ✓ | ✓ | ✓ | ✓ | ✓ |
| Zwaardlengte | 25 cm | 25 cm | 30 cm | 30 cm | 35 cm | 35 cm | 25 cm Carving |
| Ketting | 90PX (3/8" 1,1 mm) | 90PX (3/8" 1,1 mm) | 90PX (3/8" 1,1 mm) | 90PX (3/8" 1,1 mm) | 90PX (3/8" 1,1 mm) | 90PX (3/8" 1,1 mm) | 90PX (1/4", 1,3 mm) |
| Kettingsnelheid | 0 - 24,8 m/s | 0 - 24,8 m/s | 0 - 24,8 m/s | 0 - 24,8 m/s | 0 - 24,8 m/s | 0 - 24,8 m/s | 0 - 24,8 m/s |
| Gewicht | 3,8 - 4,7 kg | 3,8 - 4,7 kg | 3,8 - 4,7 kg | 3,8 - 4,7 kg | 3,8 - 4,7 kg | 3,8 - 4,7 kg | 3,8 - 4,7 kg |
| Prijs in € | excl. btw | | | | | | |
| | incl. btw | | | | | | |

Kettingzaagolie



1910U0-9



1910U1-7



195093-1



1910T9-4

| | | 1910U0-9 | 1910U1-7 | 195093-1 | 1910T9-4 |
|--------------|-----------|------------------------|------------------------|----------------------------|----------------------------|
| Omschrijving | | Kettingzaagolie Biotop | Kettingzaagolie Biotop | Kettingzaagolie (mineraal) | Kettingzaagolie (mineraal) |
| Inhoud | | 1l | 5l | 1l | 5l |
| Prijs in € | excl. btw | | | | |
| | incl. btw | | | | |

Corrosiebeschermingsolie



1910U6-7

Te gebruiken als reinigingsmiddel en corrosiebescherming bij langdurig stilstaan van uw kettingzagen.

| | | 1910U6-7 |
|--------------|-----------|--------------------------|
| Omschrijving | | Corrosiebeschermingsolie |
| Inhoud | | 0,25l |
| Prijs in € | excl. btw | |
| | incl. btw | |

DUC307 / DUC357

ACCU KETTINGZAGEN 18V



DUC357RTX2

| | DUC307ZX2 | DUC307RTX2 | DUC357ZX2 | DUC357RTX2 |
|---------------------|---------------------|---------------------|---------------------|---------------------|
| Spanning | 18V | 18V | 18V | 18V |
| Bijgeleverde accu's | - | 1x 5,0 Ah | - | 1x 5,0 Ah |
| Bijgeleverde lader | - | DC18RC | - | DC18RC |
| BL motor | ✓ | ✓ | ✓ | ✓ |
| Snelspansysteem | ✓ | ✓ | ✓ | ✓ |
| Zwaardlengte | 30 cm | 30 cm | 35 cm | 35 cm |
| Ketting | 90PX (3/8", 1,1 mm) | 90PX (3/8", 1,1 mm) | 90PX (3/8", 1,1 mm) | 90PX (3/8", 1,1 mm) |
| Kettingsnelheid | 7,7 m/s | 7,7 m/s | 7,7 m/s | 7,7 m/s |
| Gewicht | 4,2 - 4,4 kg | 4,2 - 4,4 kg | 4,2 - 4,4 kg | 4,2 - 4,4 kg |
| Prijs in € | excl. btw | | | |
| | incl. btw | | | |

DUC353 / DUC405

ACCU KETTINGZAGEN 2 x 18V



DUC405Z

| | DUC353Z | DUC405Z |
|---------------------|---------------------|----------------------|
| Spanning | 2x 18V | 2x 18V |
| Bijgeleverde accu's | - | - |
| Bijgeleverde lader | - | - |
| BL motor | ✓ | ✓ |
| Zwaardlengte | 35 cm | 40 cm |
| Bevestiging zwaard | Snelspansysteem | Geïntegreerde moeren |
| Ketting | 90PX (3/8", 1,1 mm) | 90PX (3/8", 1,1 mm) |
| Kettingsnelheid | 20 m/s | 20 m/s |
| Gewicht | 4,6 - 5,5 kg | 4,6 - 5,5 kg |
| Prijs in € | excl. btw | |
| | incl. btw | |

UC021G / UC022G / UC023G / UC024G / UC025G / UC026G

ACCU KETTINGZAGEN 40VMAX

PROMO

voor aankopen van maart t.e.m. September: Gratis 4Ah BL4040F na online registratie



UC021G
(gereedschapsloze kettingspanner)



UC025G
(geïntegreerde moeren)



UC021G-UC026G

- Krachtige accukettingzagen met een uitstekende vermogen/gewichtsverhouding
- Hoge kettingsnelheid en snelle acceleratie
- Natuurlijk aanvoelen van de belasting zoals bij een benzine kettingzaag, dit voorkomt onverwacht stoppen door overbelasting

| | UC021GZ | UC022GZ | UC023GZ | UC024GZ | UC025GZ | UC026GZ |
|---------------------|---------------------------------|---------------------------------|---------------------------------|-----------------------|-----------------------|-----------------------|
| Spanning | 36V (40Vmax) | 36V (40Vmax) | 36V (40Vmax) | 36V (40Vmax) | 36V (40Vmax) | 36V (40Vmax) |
| Bijgeleverde accu's | - | - | - | - | - | - |
| Bijgeleverde lader | - | - | - | - | - | - |
| BL motor | ✓ | ✓ | ✓ | ✓ | ✓ | ✓ |
| Zwaardbevestiging | Gereedschapsloze kettingspanner | Gereedschapsloze kettingspanner | Gereedschapsloze kettingspanner | Geïntegreerde moeren | Geïntegreerde moeren | Geïntegreerde moeren |
| Zwaardlengte | 30 cm | 35 cm | 40 cm | 30 cm | 35 cm | 40 cm |
| Ketting | 80TXL (0,325, 1,1 mm) | 80TXL (0,325, 1,1 mm) | 80TXL (0,325, 1,1 mm) | 80TXL (0,325, 1,1 mm) | 80TXL (0,325, 1,1 mm) | 80TXL (0,325, 1,1 mm) |
| Kettingsnelheid | 0 - 25,5 m/s | 0 - 25,5 m/s | 0 - 25,5 m/s | 0 - 25,5 m/s | 0 - 25,5 m/s | 0 - 25,5 m/s |
| Gewicht | 5,3 kg - 5,5 kg | 5,3 kg - 5,5 kg | 5,3 kg - 5,5 kg | 5,3 kg - 5,5 kg | 5,3 kg - 5,5 kg | 5,3 kg - 5,5 kg |
| Prijs in € | excl. btw | | | | | |
| | incl. btw | | | | | |

UC010G / UC011G / UC012G / UC013G

ACCU KETTINGZAGEN 40Vmax



PROMO

voor aankopen van maart t.e.m. September: Gratis 4Ah BL4040F na online registratie



UC012GT102



UC013GT102



HOOG VERMOGEN
HOGE KETTINGSNELHEID
REGELBAAR OLIEDEBIET
LAAGTRILLINGSNIVEAU

| | UC010GZ | UC010GT101 | UC011GZ | UC011GT101 | UC012GZ01 | UC012GT102 | UC013GZ01 | UC013GT102 |
|----------------------|-----------------------|-----------------------|-----------------------|-----------------------|--------------|--------------|--------------|--------------|
| Spanning | 36V (40Vmax) | 36V (40Vmax) | 36V (40Vmax) | 36V (40Vmax) | 36V (40Vmax) | 36V (40Vmax) | 36V (40Vmax) | 36V (40Vmax) |
| Bijgeleverde accu's | - | 1 x 5,0 Ah | - | 1 x 5,0 Ah | - | 1 x 5,0 Ah | - | 1 x 5,0 Ah |
| Bijgeleverde lader | - | DC40RA | - | DC40RA | - | DC40RA | - | DC40RA |
| BL motor | ✓ | ✓ | ✓ | ✓ | ✓ | ✓ | ✓ | ✓ |
| Geïntegreerde moeren | ✓ | ✓ | ✓ | ✓ | ✓ | ✓ | ✓ | ✓ |
| Zwaardlengte | 30 cm | 30 cm | 35 cm | 35 cm | 40 cm | 40 cm | 45 cm | 45 cm |
| Ketting | 80TXL (0,325, 1,1 mm) | 80TXL (0,325, 1,1 mm) | 80TXL (0,325, 1,1 mm) | 80TXL (0,325, 1,1 mm) | 3/8" 1,3 mm | 3/8" 1,3 mm | 3/8" 1,3 mm | 3/8" 1,3 mm |
| Kettingsnelheid | 0 - 25,5 m/s | 0 - 25,5 m/s | 0 - 25,5 m/s | 0 - 25,5 m/s | 0 - 25,5 m/s | 0 - 25,5 m/s | 0 - 25,5 m/s | 0 - 25,5 m/s |
| Gewicht | 6,1 - 7,4 kg | 6,1 - 7,4 kg | 6,1 - 7,4 kg | 6,1 - 7,4 kg | 6,1 - 7,4 kg | 6,1 - 7,4 kg | 6,1 - 7,4 kg | 6,1 - 7,4 kg |
| Prijs in € | excl. btw | | | | | | | |
| | incl. btw | | | | | | | |

DUA200

ACCU HOOGSNOEIER 18 V



Na het drukken op de deblokkeerknop kan de zaagkop tot + 60° of -60° gekanteld worden.

- De schacht bestaat uit 3 segmenten die via een handig schroefmechanisme aan elkaar gekoppeld worden. De totale lengte is 1,620 m (twee segmenten) of 2,5 m (drie segmenten).
- De smalle, lichte zaagkop laat toe gemakkelijk tussen takken te bewegen
- De zaagkop kan 60° opwaarts en 60° neerwaarts gekanteld worden
- De zaagketting kan zonder gereedschap aangespannen en gewisseld worden



NIEUW

DUA200Z

| | | |
|---------------------|---------------------------------|--|
| Spanning | 18V (40Vmax) | |
| Bijgeleverde accu's | - | |
| Bijgeleverde lader | - | |
| BL motor | ✓ | |
| Totale lengte | 1620 - 2520 mm | |
| Bevestiging zwaard | Gereedschapsloze kettingspanner | |
| Zwaardlengte | 200 mm | |
| Ketting | 80TXL (0,325", 1,1 mm) | |
| Kettingsnelheid | 6,7 m/s | |
| Gewicht | 3,2 - 3,5 kg | |
| Prijs in € | excl. btw | |
| | incl. btw | |

DUA200Z

DUA301

ACCU HOOGSNOEIER 2 x 18 V

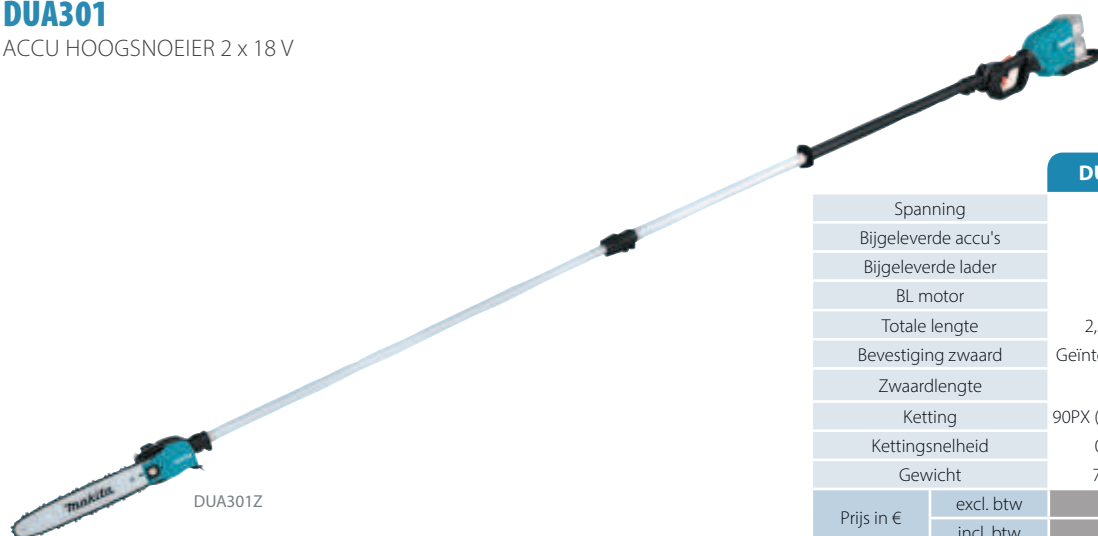

DUA301Z

| | DUA301Z | DUA301PT2 |
|---------------------|-----------------------|-----------------------|
| Spanning | 2x 18V | 2x 18V |
| Bijgeleverde accu's | 0 | 2x 5,0 Ah |
| Bijgeleverde lader | - | DC18RD |
| BL motor | ✓ | ✓ |
| Totale lengte | 2,53 - 3,76 m | 2,53 - 3,76 m |
| Bevestiging zwaard | Geïntegreerde moer | Geïntegreerde moer |
| Zwaardlengte | 30 cm | 30 cm |
| Ketting | 90PX (0,325", 1,1 mm) | 90PX (0,325", 1,1 mm) |
| Kettingsnelheid | 0 - 20 m/s | 0 - 20 m/s |
| Gewicht | 7,8 - 8,5 kg | 7,8 - 8,5 kg |
| Prijs in € | excl. btw | |
| | incl. btw | |

UA004G

ACCU HOOGSNOEIER 40VMAX



UA004GZ

PROMO
 voor aankopen van maart t.e.m. September:
 Gratis 4Ah BL4040F na online registratie"

| | UA004GZ | UA004GM101 |
|---------------------|-----------------------|-----------------------|
| Spanning | 36V (40Vmax) | 36V (40Vmax) |
| Bijgeleverde accu's | - | 1x 4,0 Ah |
| Bijgeleverde Lader | - | DC40RA |
| BL motor | ✓ | ✓ |
| Totale lengte | 2,53 - 3,76 m | 2,53 - 3,76 m |
| Bevestiging zwaard | Geïntegreerde moer | Geïntegreerde moer |
| Zwaardlengte | 30 cm | 30 cm |
| Ketting | 90PX (0,325", 1,1 mm) | 90PX (0,325", 1,1 mm) |
| Kettingsnelheid | 0 - 20 m/s | 0 - 20 m/s |
| Gewicht | 7,8 - 9,1 kg | 7,8 - 9,1 kg |
| Prijs in € | excl. btw | |
| | incl. btw | |

DUX18Z

ACCU COMBISYSTEEM 18 V



DUX18Z

| | |
|------------------------------|--|
| Platform | LXT 18 V |
| Max. afgegeven vermogen | 470 W |
| Toerental onbelast | 0 - 6800 / 0 - 9700 min ⁻¹ |
| Bijgeleverde accessoires | - |
| Bijgeleverde accu's / laders | - |
| Prijs in € | excl. btw |
| | incl. btw |

DUX18ZX1

ACCU COMBISYSTEEM 18 V



DUX18ZX1

| | |
|------------------------------|--|
| Platform | LXT 18 V |
| Max. afgegeven vermogen | 470 W |
| Toerental onbelast | 0 - 6800 / 0 - 9700 min ⁻¹ |
| Bijgeleverde accessoires | EM408MP |
| Bijgeleverde accu's / laders | - |
| Prijs in € | excl. btw |
| | incl. btw |

UX01GZ

ACCU COMBISYSTEEM 40VMAX



PROMO

voor aankopen van maart t.e.m. september '25: Gratis 4 Ah BL4040F na online registratie



UX01GZ

UX01GZ01

| | | |
|------------------------------|---|---|
| Platform | XGT 40Vmax | XGT 40Vmax |
| Max. afgegeven vermogen | 1000 W | 1000 W |
| Toerental onbelast | 0 - 5700 / 0 - 8200 / 0 - 9700 min ⁻¹ | 0 - 5700 / 0 - 8200 / 0 - 9700 min ⁻¹ |
| Bijgeleverde accessoires | - | EM404MP |
| Bijgeleverde accu's / laders | - | - |
| Prijs in € | excl. btw | |
| | incl. btw | |

Grastrimmer

ER400MP (Art.nr. 195522-4)

Maaibreedte 410 mm
(excl. btw)
(incl. btw)



Bosmaaier (zwaar werk)

EM401MP (Art.nr. 195888-2)

Maaibreedte 300 mm
Ø draad 2,7 mm
Geschikt voor slagmes Ø 230 mm
(excl. btw)
(incl. btw)



DUX60



ACCU COMBISYSTEEM 2 x 18 V



DUX60Z

DUX60ZN1

DUX60ZM4

DUX60ZM4-P

DUX60ZX8

| | | | | | |
|------------------------------|--|--|--|--|--|
| Platform | LXT 2 x 18 V | LXT 2 x 18 V | LXT 2 x 18 V | LXT 2 x 18 V | LXT 2 x 18 V |
| Max. afgegeven vermogen | 600 W | 600 W | 600 W | 600 W | 600 W |
| Toerental onbelast | 0 - 5700 / 0 - 8200 / 0 - 9700 min ⁻¹ | 0 - 5700 / 0 - 8200 / 0 - 9700 min ⁻¹ | 0 - 5700 / 0 - 8200 / 0 - 9700 min ⁻¹ | 0 - 5700 / 0 - 8200 / 0 - 9700 min ⁻¹ | 0 - 5700 / 0 - 8200 / 0 - 9700 min ⁻¹ |
| Bijgeleverde accessoires | - | EN401MP | EM404MP | EM404MP DEAPF400MP | EN401MP EM404MP |
| Bijgeleverde accu's / laders | - | - | - | - | - |
| Prijs in € | excl. btw | | | | |
| | incl. btw | | | | |

Bosmaaier

EM404MP (Art.nr. 198768-1)

Maaibreedte 420 mm
Ø draad 2,0 mm
Geschikt voor slagmes Ø 230 mm
(excl. btw)
(incl. btw)



Bosmaaier

EM408MP (Art.nr. 191N31-5)

Maaibreedte 300 mm
Ø draad 2,0 mm
Geschikt voor slagmes Ø 230 mm
(excl. btw)
(incl. btw)



Rotorschaar

EM407MP (Art.nr. 191M56-3)

Maaibreedte 230 mm
 Reduceert opspattende steentjes
 (excl. btw)
 (incl. btw)

**Schoffel**

WA400MP (Art.nr. 1913P8-6)

Werkbreedte 220 mm
 Oscillatiehoek 19°
 Gewicht: 2,8 kg
 (excl. btw)
 (incl. btw)

**Waterpomp opzetstuk**

DEAPF400MP (Art.nr. DEAPF400MP)

Max. debiet 120 - 150 L/ min
 Max. opvoerhoogte 13 m
 (excl. btw)
 (incl. btw)

**Stokheggenschaar (135° kantelbaar)**

EN401MP (Art.nr. 196256-2)

Werkbreedte 49 cm
 Totale lengte 158 cm
 Gewicht: 2,8 kg
 (excl. btw)
 (incl. btw)

**Blazer (laag geluidsniveau)**

UB401MP (Art.nr. 191P72-3)

Max. debiet 16,4 m³/ min
 Gewicht 2,1 kg
 (excl. btw)
 (incl. btw)

**Grondfrees**

KR401MP (Art.nr. 199181-6)

Werkbreedte 22 cm
 (excl. btw)
 (incl. btw)

**Stokheggenschaar (vast)**

EN410MP (Art.nr. 197726-4)

Werkbreedte 49 cm
 Totale lengte 110 cm
 Niet kantelbaar
 (excl. btw)
 (incl. btw)

**Blazer (licht & compact)**

UB402MP (Art.nr. 1912R8-4)

Max. debiet 5,9 m³/ min
 Gewicht 1,2 kg
 (excl. btw)
 (incl. btw)

**Kantensnijder**

EE400MP (Art.nr. 196752-0)

Meslengte 20,3 cm
 (excl. btw)
 (incl. btw)

**Stokheggenschaar**

EN402MP (Art.nr. 1912T8-8)

Werkbreedte 50 cm
 niet inklapbaar
 (excl. btw)
 (incl. btw)

**Snoeikettingzaag**

EY403MP (Art.nr. 191T38-7)

Zwaardlengte 30 cm
 Kettingsteek 3/8"
 Groefbreedte 1,1 mm
 (excl. btw)
 (incl. btw)

**Rolveger**

SW400MP (Art.nr. 199339-7)

Rolbreedte 59 cm
 (excl. btw)
 (incl. btw)

**Stokheggenschaar**

EN422MP (Art.nr. 1912T0-4)

Werkbreedte 25 cm
 (excl. btw)
 (incl. btw)

**Rolborstel**

BR400MP (Art.nr. 199318-5)

Rolbreedte 60 cm
 (excl. btw)
 (incl. btw)

**NIEUW****Sneeuwblazer**

SN400MP (Art.nr. EUASN400MP)

Werkbreedte 300 mm
 Instelbare werprijting
 (excl. btw)
 (incl. btw)

**Maaibalk**

EN424MP (Art.nr. 1913C9-3)

Snijbreedte 33 cm
 (excl. btw)
 (incl. btw)

**Verlengstuk**

LE400MP (Art.nr. 191E24-8)

Lengte 1,08 m
 (excl. btw)
 (incl. btw)



DDG460 / DDG461

ACCU GRONDBOOR 2 x 18 V

LXT

ADT

BL MOTOR

XPT

18V + 18V → 36V

DDG460 is uitgerust met boorkop; voor het aansluiten van een grondboor is een adapter nodig (Type "D" voor Makita grondboren, Type "A" voor Stihl grondboren). De DDG461 daarentegen heeft een as-pen opname waar de Makita grondboren rechtstreeks op passen.

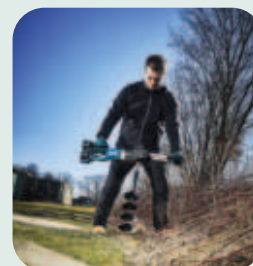

DDG460T2X7



Boorkop aansluiting

Rechtstreekse aansluiting

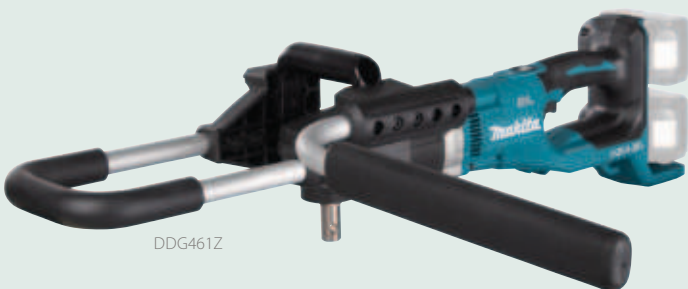

DDG461Z

| | DDG460T2X7 | DDG461Z |
|---------------------|---|---|
| Spanning | 2 x 18 V | 36 V (40Vmax) |
| Bijgeleverde accu's | 2x BL1850B | - |
| Bijgeleverde lader | DC18RD | - |
| Max. diameter boor | 200 mm | 200 mm |
| Opname | Boorkop | Directe aansluiting |
| Max. koppel | 136 Nm | 136 mm |
| Toerental onbelast | 0 - 350 min ⁻¹ 0 - 1400 min ⁻¹ | 0 - 350 min ⁻¹ 0 - 1400 min ⁻¹ |
| Gewicht | | 7,0 - 7,6 kg |
| Prijs in € | excl. btw | |
| | incl. btw | |



Omkeerschakelaar

De draairichting kan omgekeerd worden om de boor los te maken wanneer ze geblokkeerd geraakt is of te diep vastzit in zware kleigrond.



Slipkoppeling

De slipkoppeling verbreekt de verbinding tussen de motor en de boor wanneer het koppel een extreme waarde overschrijdt. Dat voorkomt schade aan de machine en verhoogt de veiligheid voor de gebruiker.

DG001G / DG002G

ACCU GRONDBOOR 40VMAX

ADT

BL MOTOR

XPT

XGT 40V max

PROMO

voor aankopen van maart t.e.m. september '25: gratis BL4040F na online registratie

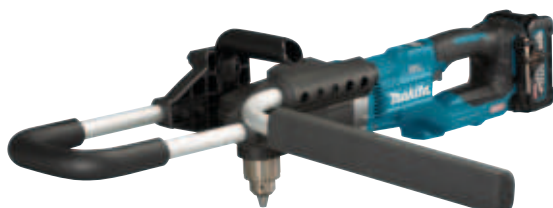

DG001GM105



DG002GZ



DG001G is uitgerust met boorkop. Voor het aansluiten van een grondboor is een adapter nodig. (Type D voor Makita grondboren, Type A voor Stihl grondboren) De DG002G heeft een as-pen opname waar de Makita grondboren rechtstreeks op passen.



Boorkop aansluiting

Rechtstreekse aansluiting

| | DG001GZ05 | DG001GM105 | DG002GZ |
|---------------------|---|---|---|
| Spanning | 36V (40Vmax) | 36V (40Vmax) | 36V (40Vmax) |
| Bijgeleverde accu's | - | 1x BL4040 | - |
| Bijgeleverde lader | - | DC40RA | - |
| Max. diameter boor | 200 mm | 200 mm | 200 mm |
| Opname | Boorkop | Boorkop | Directe opname |
| Max. koppel | 136 Nm | 136 Nm | 136 Nm |
| Toerental onbelast | 0 - 350 min ⁻¹ 0 - 1400 min ⁻¹ | 0 - 350 min ⁻¹ 0 - 1400 min ⁻¹ | 0 - 350 min ⁻¹ 0 - 1400 min ⁻¹ |
| Gewicht | 7,2 - 8,1 kg | 7,2 - 8,1 kg | 7,2 - 8,1 kg |
| Prijs in € | excl. btw | | |
| | incl. btw | | |



Adapters



327687-6
Adapter Type D
voor Makita grondboren



327684-2
Adapter Type A
voor Stihl grondboren

Grondboren met hexagonale schacht passen in een standaard boorkop. Ze kunnen dus gebruikt worden op accu boormachines en haakse boormachines op voorwaarde dat het koppel van de machine hoog genoeg is.

Grondboren met hexagonale schacht 13 mm

Rechtstreeks passend op DDG460/DG001G en boormachines met een gewone boorkop

| Artikel nr. | Diameter | Totale lengte | Nuttige lengte | Spiraal | Prijs (excl. btw) | Prijs (incl. btw) |
|-------------|----------|---------------|----------------|-----------------|-------------------|-------------------|
| D-75415 | Ø 30 mm | 600 mm | 200 mm | Enkele spiraal | | |
| D-75421 | Ø 45 mm | 600 mm | 200 mm | Enkele spiraal | | |
| D-75437 | Ø 70 mm | 600 mm | 200 mm | Enkele spiraal | | |
| D-75443 | Ø 100 mm | 600 mm | 200 mm | Enkele spiraal | | |
| D-75459 | Ø 130 mm | 600 mm | 200 mm | Enkele spiraal | | |
| E-17049 | Ø 40 mm | 600 mm | 470 mm | Dubbele spiraal | | |



Plantgatboren voor gebruik in bewerkte, losse grond.

E-17049: zware uitvoering voor het boren in zware of steenachtige grond.

Grondboren met as-pen aansluiting

Rechtstreeks passend op DG002G/DHG461 en via adapter type D op machines met een standaard boorkop zoals DDG460/DG001G

| Artikel nr. | Diameter | Totale lengte | Nuttige lengte | Prijs (excl. btw) | Prijs (incl. btw) |
|-------------|----------|---------------|----------------|-------------------|-------------------|
| E-13611 | Ø 50 mm | 800 mm | 550 mm | | |
| E-13627 | Ø 60 mm | 800 mm | 550 mm | | |
| E-13633 | Ø 80 mm | 800 mm | 550 mm | | |
| E-07294 | Ø 100 mm | 800 mm | 550 mm | | |
| E-07303 | Ø 150 mm | 800 mm | 550 mm | | |
| E-07319 | Ø 200 mm | 800 mm | 550 mm | | |

| Vervangmesjes | Prijs (excl. btw) | Prijs (incl. btw) |
|---------------|-------------------|-------------------|
|---------------|-------------------|-------------------|

E-13649

E-13655

E-13661

E-07630

E-07646

E-07652



E-07325
Verlengstuk
540 mm



E-07331
Borgpen

DHW180Z

ACCU WATERSPUIT 18 V

XPT LXT



| | | DHW180Z |
|---------------------|-----------|-----------------|
| Spanning | | 18V |
| Bijgeleverde accu's | | - |
| Lader | | - |
| Werkdruk | | 24 bar / 8 bar |
| Werkdebiet | | 2,5 / 1,5 l/min |
| Max. aanzuighoogte | | 2,0 m |
| Gewicht | | 2,4 - 2,8 kg |
| Prijs in € | excl. btw | |
| | incl. btw | |

Leverbaar vanaf juli 2025

HW001G

ACCU HOGEDRUKREINIGER 40VMAX

XGT 40Vmax

BL MOTOR

XPT
EXTREME PROTECTION TECHNOLOGY

PROMO

voor aankopen van maart t.e.m. september '25: gratis BL4040F na online registratie"



HW001G

- Hoge reinigingskracht met goede balans tussen druk en debiet
- Voeding middels één of twee 40Vmax accu's
- 3 vermogensstanden
- Telescopisch handvat en compartiment voor de accessoires
- Autonomie bij max. vermogen: 18 min (2x BL4050F)
- De pomp is zelfaanzuigend, er kan ut een waterreservoir gepompt worden (aanzuigslang standaard inbegrepen).

HW001GZ

| | | |
|---------------------------|-----------|-----------------------|
| Spanning | | 36 V (40Vmax) |
| Bijgeleverde accu's/lader | | - |
| Werkdruk | | 30/55/85 bar |
| Debiet | | 3,0 - 4,2 - 5,5 l/min |
| Lengte hogedrukslang | | 6 m |
| Gewicht | | 10,1 - 13,2 kg |
| Prijs in € | excl. btw | |
| | incl. btw | |



DHW080

ACCU HOGEDRUKREINIGER 2 X 18 V

18v + 18v → 36v

BL MOTOR

XPT
EXTREME PROTECTION TECHNOLOGY

Compatibel

Er is een breed assortiment aan hulpstukken beschikbaar, ze zijn ook compatibel met de HW1200 / HW1300.



DHW080ZK

| | | |
|----------------------|-----------|---------------|
| Spanning | | 2 x 18 V |
| Bijgeleverde accu's | | - |
| Bijgeleverde lader | | - |
| Werkdruk (laag/hoog) | | 30/55 bar |
| Debiet (laag/hoog) | | 4,0/5,5 l/min |
| Lengte hogedrukslang | | 5 m |
| Inhoud watertank | | 50 l |
| Gewicht | | 7,1-7,7 kg |
| Prijs in € | excl. btw | |
| | incl. btw | |

US053D / DUS054

ACCU COMPACTE SPROEIER

- Schoudergedragen model met een 5 l tank
- De twee spuitmonden zijn afzonderlijk te activeren voor small of breed sproeien.
- Uitschuifbare spuitlans: 0,5 – 0,7 m
- Enkel geschikt voor het verwerken van op water gebaseerde gazon- en tuin chemicaliën.



CXI LXT XPT

| | | US053DZ | DUS054Z |
|---------------------|-----------|--------------------|--------------------|
| Spanning | | 12Vmax | 18 V |
| Bijgeleverde accu's | | - | - |
| Tankinhoud | | 5 l | 5 l |
| Debiet | | 0,46-0,6 l/min | 0,46-0,6 l/min |
| Max. druk | | 3,0 bar | 3,0 bar |
| Afmetingen | | 340 x 183 x 360 mm | 340 x 183 x 360 mm |
| Gewicht | | 2,9 - 3,0 kg | 3,2 - 3,5 kg |
| Prijs in € | excl. btw | | |
| | incl. btw | | |

DUS108 / DUS158

ACCU RUGSPROEIERS

- Ruggedragen modellen.
- Standaard geleverd met enkele- en dubbele sproeikop.
- Enkel geschikt voor op water gebaseerde gazon- en tuin chemicaliën.



LXT XPT

| | | DUS108Z | DUS158Z |
|---------------------|-----------|--------------------|--------------------|
| Spanning | | 18 V | 18 V |
| Bijgeleverde accu's | | - | - |
| Tankinhoud | | 10 l | 15 l |
| Debiet | | 0,8 - 1,3 l/min | 0,8 - 1,3 l/min |
| Max. druk | | 5,0 bar | 5,0 bar |
| Afmetingen | | 325 x 237 x 439 mm | 325 x 237 x 517 mm |
| Gewicht | | 5,6 - 5,9 kg | 5,9 - 6,2 kg |
| Prijs in € | excl. btw | | |
| | incl. btw | | |

PF0800 / PF1100

DOMPELPOMPEN VOOR ZUIVER WATER



PF1010 / PF1110

DOMPELPOMPEN VOOR VUIEL WATER

| | | PF0800 | PF1010 | PF1100 | PF1110 |
|-------------------|-----------|-----------|-----------|-----------|-----------|
| Nominale vermogen | | 800 W | 1100 W | 1100 W | 1100 W |
| Max. debiet | | 220 l/min | 240 l/min | 250 l/min | 250 l/min |
| Max. opvoerhoogte | | 9 m | 10 m | 9 m | 10 m |
| Gewicht | | 6,1 kg | 6,6 kg | 6,7 kg | 7,0 kg |
| Prijs in € | excl. btw | | | | |
| | incl. btw | | | | |



HW1200 / HW1300 / HW131 / HW151

ELEKTRISCHE HOGEDRUKREINIGERS

| | | HW1200 | HW1300 | HW131 | HW151 |
|-------------------|-----------|---------|---------|---------|---------|
| Nominale vermogen | | 1800 W | 1800 W | 2200 W | 2500 W |
| Max. druk | | 120 bar | 130 bar | 130 bar | 150 bar |
| Max. debiet | | 420 l/h | 420 l/h | 500 l/h | 500 l/h |
| Haspel | | 10 m | 10 m | 15 m | 10 m |
| Gewicht | | 11,0 kg | 12,7 kg | 33 kg | 26,9 kg |
| Prijs in € | excl. btw | | | | |
| | incl. btw | | | | |

UP100D

SNOEISCHAAR 12VMAX



UP100DSMJ

| | |
|-----------------------------|------------------|
| Spanning | 10,8 V |
| Bijgeleverde accu's | 1x BL1041B |
| Bijgeleverde lader | DC10SB |
| Maximaal afgegeven vermogen | 170 W |
| Snijcapaciteit | 25 mm |
| Afmetingen (L x B x H) | 259 x 53 x 98 mm |
| Gewicht | 0,89 - 1,1 kg |
| Prijs in € | excl. btw |
| | incl. btw |

DUP180

ACCU SNOEISCHAAR 18 V



DUP180Z

| | |
|-----------------------------|------------------|
| Spanning | 18 V |
| Bijgeleverde accu's | - |
| Bijgeleverde lader | - |
| Maximaal afgegeven vermogen | 370 W |
| Snijcapaciteit | 30 mm |
| Afmetingen (L x B x H) | 296 x 40 x 99 mm |
| Gewicht | 0,68 kg |
| Prijs in € | excl. btw |
| | incl. btw |

DUP362

ACCU SNOEISCHAAR 2 x 18 V

36V XPT



Inclusief
harnas & holster

DUP362Z

DUP362PT2

| | | |
|---------------------|-----------|-----------------|
| Bijgeleverde accu's | - | 2 x accu 5,0 Ah |
| Bijgeleverde lader | - | DC18RD |
| Snijcapaciteit | 33 mm | 33 mm |
| Gewicht | 3,3 kg | 3,3 kg |
| Prijs in € | excl. btw | |
| | incl. btw | |



UP100D & DUP180

- Lichtgewicht en slanke greep dankzij ultracompacte BL motor zonder metalen kern
- Met servosturing: het mes volgt de bewegingen van de vinger op de triggerschakelaar

DUP180: versie voor LXT accu's, met batterijadapter die aan de heup bevestigd wordt en een kabel naar de snoeischaar.

UP100D: versie voor CXT accu's, de accu zit achteraan op de snoeischaar. Bijzonder geschikt voor fijn snoeiwerk.

UD2500

ELEKTRISCHE HAKSELAAR



UD2500

| | |
|-------------------------|-----------|
| Nominaal vermogen | 2500 W |
| Max. toerental onbelast | 40 t.p.m |
| Max. takdikte | 45 mm |
| Geluidsdruk | 84 dB(A) |
| Gewicht | 29,7 kg |
| Prijs in € | excl. btw |
| | incl. btw |

DCU180Z ACCU KRUIWAGEN 18 V



Elektronische snelheidsregeling



Demonteerbare achterwielen



Geïntegreerde ledverlichting



PROMO
GRATIS BUIZENFRAME
(199009-8)

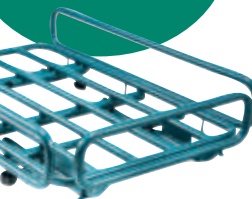

- Onderstel te combineren met een verstelbaar buizenframe of een kantelbare kuip.
- Frame lengte: 1110 - 1350 mm, breedte: 820 - 1010 mm

| DCU180Z | |
|---------------|----------------|
| Spanning | 18 V |
| Rijsnelheid | 0 - 3,5 km/u |
| Draagvermogen | 130 kg |
| Max. helling | 12° |
| Gewicht | 39,3 - 44,8 kg |
| Prijs in € | excl. btw |
| | incl. btw |

DCU603 / DCU604 / DCU605 / DCU601 / DCU602 ACCU TRANSPORTERS 2 x 18 V



DCU603

Met kuip en manuele kiepfunctie



DCU605

Met vaste, vlakke kuip



DCU604

Met frame en manuele kiepfunctie



DCU601

Plateau met elektrische lift



DCU602

Met kuip en elektrische kiepfunctie



DCU601Z

- Transporter met elektrohydraulische lift
- Ideaal voor het optillen van zware lasten om bijvoorbeeld over te laden in een bestelwagen of aanhangwagen
- De zijsteunen kunnen verlaagd worden tot onder het platform
- Maximum hefcapaciteit 300 kg



DCU602Z

- Dumper met elektrohydraulische kiepfunctie
- De laadbak kan elektrisch worden gekiept tot 75° en handmatig tot 110°
- Maximum hefcapaciteit 300 kg

| | DCU603Z | DCU604Z | DCU605Z | DCU601Z | DCU602Z |
|--------------------------------|----------------------|----------------------|----------------------|------------------------------|----------------------------|
| Spanning | 2 x 18V | 2 x 18V | 2 x 18V | 2 x 18V | 2 x 18V |
| Type | Kantelbare kuip | Kantelbaar frame | Vaste kuip | Plateau met elektrische lift | Elektrisch kantelbare kuip |
| Volume kuip | 100 l | - | 250 l | - | 100 l |
| Max. lading vlak terrein | 300 kg | 300 kg | 300 kg | 300 kg | 300 kg |
| Max. lading helling (3° - 12°) | 180 kg | 180 kg | 180 kg | 180 kg | 180 kg |
| Rijsnelheid vooruit | 1,5 - 3,5 - 5,0 km/h | 1,5 - 3,5 - 5,0 km/h | 1,5 - 3,5 - 5,0 km/h | 1,5 - 3,5 - 5,0 km/h | 1,5 - 3,5 - 5,0 km/h |
| Rijsnelheid achteruit | 1,0 km/h | 1,0 km/h | 1,0 km/h | 1,0 km/h | 1,0 km/h |
| Gewicht | 122 - 124 kg | 122 - 124 kg | 122 - 124 kg | 145 kg | 147 kg |
| Prijs in € | excl. btw | | | | |
| | incl. btw | | | | |

DLX4181PT2

ACCU COMBOPACK TUIN

18V + 18V → 36V

18V LITHIUM-ION



DLX4181PT2

| | | |
|---------------------|------------|--|
| Bijgeleverde accu's | 2x BL1850B | |
| Duo snellader | DC18RD | |
| Heggenschaar | DUH507 | |
| Bladblazer | DUB184 | |
| Grastrimmer | DUR193 | |
| Grasmaaier | DLM432 | |
| Prijs in € | excl. btw | |
| | incl. btw | |

DLX5057PTJ

ACCU COMBOPACK TUIN

18V + 18V → 36V

XPT

BL MOTOR

18V LITHIUM-ION



DLX5057PTJ

| | | |
|---------------------|-----------------|--|
| Bijgeleverde accu's | 4 x accu 5,0 Ah | |
| Duo snellader | DC18RD | |
| Heggenschaar | DUH601 | |
| Kettingzaag | DUC353 | |
| Grastrimmer | DUR368 | |
| Grasmaaier | DLM463 | |
| Bladblazer | DUB362 | |
| Prijs in € | excl. btw | |
| | incl. btw | |

PDC: Makita's accupack platform

PDC01 - PDC1200 - PDC1500



VERBINDING PDC VIA STANDAARD CONNECTOR



UB001C
UB003C



VR00xC
Betontrilnaalden



UR101C



BEVESTIGING PDC OP DE MACHINE



LM001C



UB002C



BAC01

Combinatie met PDC01 (art.nr. BAC01PDC01BE) Combinatie met PDC1200 (art. nr. BAC01PDC1200BE)

De BAC01 in combinatie met PDC levert een 230 V wisselspanning op locatie.

VERBINDING PDC MET LXT/XGT TOOLS



18V LXT *



2 x 18V LXT



40Vmax XGT

191J50-7
Adapter 18V LXT*



191J51-5
Adapter 2x18V LXT



191N62-4
Adapter 40Vmax XGT



* 18V LXT enkel in combinatie met PDC01

Stroomomvormer BAC01 voor PDC (accupack)



De PDC01 unit kan één tot 4 LXT accu's bevatten.

De batterijunit kan ook los van het harnas gebruikt worden.



PDC01
432 Wh max.

PDC1200
1206 Wh

PDC1500
1567,8 Wh

| | PDC01 | | |
|------------------------------|--------------------|------------------------------------|------------------------------------|
| Bestelreferentie | 191A64-2 | 191A59-5 | 191C50-5 |
| Accu | 1 tot 4 LXT accu's | 1 tot 4 LXT accu's | 1 tot 4 LXT accu's |
| Energiecapaciteit | Max. 432 Wh | Max. 432 Wh | Max. 432 Wh |
| Meegeleverde adapters | 2x 18V (191J51-5) | 18V (191J50-7) 2x18V (191J51-5) | 18V (191J50-7) 2x18V (191J51-5) |
| Bijgeleverde accu's | - | - | 4 x 5,0 Ah |
| Bijgeleverde lader | - | - | DC18RD |
| Netto gewicht | 4,0 kg | 4,0 kg | 4,0 kg |
| Gewicht incl. accu en harnas | 7,0 kg | 7,0 kg | 7,0 kg |
| Prijs in € | excl. btw | | |
| | incl. btw | | |

| | PDC1200 | PDC1500 | |
|-----------------------|------------------|---------------|--|
| Bestelreferentie | BEAPDC1200A01 | EUAPDC1500A01 | |
| Accu | Geïntegreerd | Geïntegreerd | |
| Energiecapaciteit | 1206 Wh | 1567,8 Wh | |
| Bijgeleverde lader | DC4001 | DC4001 | |
| Laadtijd | 6 uur | 8 uur | |
| Meegeleverde adapters | 2x18V (191J51-5) | - | |
| Gewicht incl. harnas | 8,8 kg | 13,9 kg | |
| Prijs in € | excl. btw | | |
| | incl. btw | | |

| Accessoire | Ref. | Prijs excl. btw | Prijs incl. btw |
|---------------------|----------|-----------------|-----------------|
| Adapter 18V (PDC01) | 191J50-7 | | |
| Adapter 2 x 18V | 191J51-5 | | |
| Adapter 40Vmax | 191N62-4 | | |
| Lader DC4001 | 191L00-4 | | |

| | EUABAC01 | BAC01PDC01BE | BAC01PDC1200BE |
|------------|-----------|--------------|----------------|
| Uitvoering | BAC01 | BAC01+PDC01* | BAC01+PDC1200 |
| Prijs € | excl. btw | | |
| | incl. btw | | |



makitaredemption.eu/be/nl



PROMO



GRATIS HIGH PERFORMANCE BL4040F

Na registratie op www.makitaredemption.eu/be/nl
(Zie hieronder voor de actievoorwaarden)

GELDIG OP:

- ALLE XGT TUINMACHINES (BEHALVE LM003G/LM004G)
- ALLE DIRECT-CONNECT MODELLEN
- OOK BIJ VS001G, CE001G, CE002G, CE003G EN CE004G

Ontvang een gratis batterij!

Van 01/03/2025 t.e.m. 30/09/2025 kan u bij aankoop van de bovenstaande producten een gratis batterij aanvragen! Voor de gratis producten na online registratie: surf naar www.makitaredemption.eu/be/nl en vul het formulier in. Na ontvangst van de correcte gegevens sturen we het gratis product zo snel mogelijk naar u toe.

VOOR AANKOPEN TUSSEN 01/03/2025 - 30/09/2025



IPL.BE
GROUP

INDUSTRY PARTS
LIMBURG

Gerard Mercatorstraat 28
B-3920 Lommel

INFO@IPLGROUP.BE
011.54.44.87

